

# Reference Handbook for Site-Specific Assessment of Subsurface Vapor Intrusion to Indoor Air

Technical Report

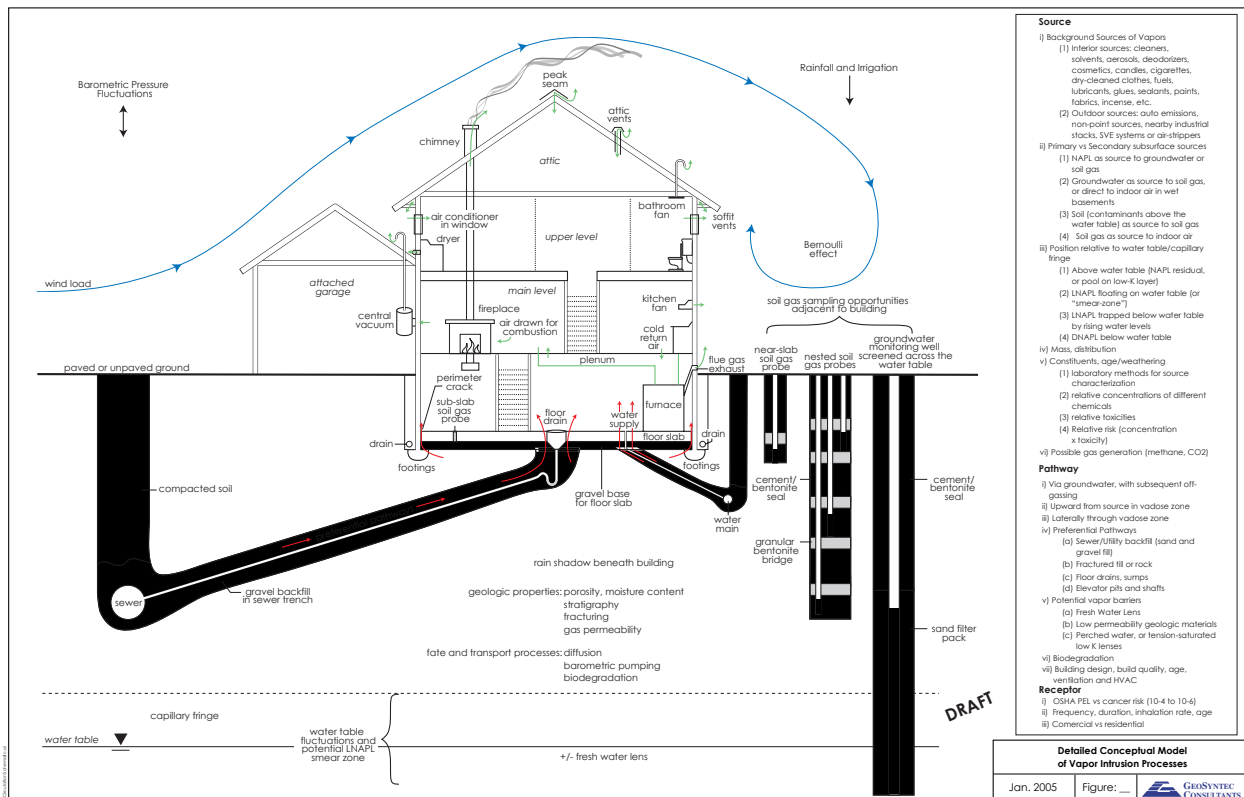



# Reference Handbook for Site-Specific Assessment of Subsurface Vapor Intrusion to Indoor Air

1008492

Final Report, March 2005

## Cosponsors

Alliant Energy Corporation  
Consolidated Edison Co. of New York, Inc.  
Exelon Corporation  
First Energy Corp.  
Honeywell, Inc.  
KeySpan Energy  
New York State Electric & Gas Corp.  
NiSource Inc.  
Orange & Rockland Utilities, Inc.  
PPL Services Corp.  
Public Service Electric & Gas Co.  
Rochester Gas & Electric Corp.  
We Energies

EPRI Project Manager  
A. Jain

## **DISCLAIMER OF WARRANTIES AND LIMITATION OF LIABILITIES**

THIS DOCUMENT WAS PREPARED BY THE ORGANIZATION(S) NAMED BELOW AS AN ACCOUNT OF WORK SPONSORED OR COSPONSORED BY THE ELECTRIC POWER RESEARCH INSTITUTE, INC. (EPRI). NEITHER EPRI, ANY MEMBER OF EPRI, ANY COSPONSOR, THE ORGANIZATION(S) BELOW, NOR ANY PERSON ACTING ON BEHALF OF ANY OF THEM:

(A) MAKES ANY WARRANTY OR REPRESENTATION WHATSOEVER, EXPRESS OR IMPLIED, (I) WITH RESPECT TO THE USE OF ANY INFORMATION, APPARATUS, METHOD, PROCESS, OR SIMILAR ITEM DISCLOSED IN THIS DOCUMENT, INCLUDING MERCHANTABILITY AND FITNESS FOR A PARTICULAR PURPOSE, OR (II) THAT SUCH USE DOES NOT INFRINGE ON OR INTERFERE WITH PRIVATELY OWNED RIGHTS, INCLUDING ANY PARTY'S INTELLECTUAL PROPERTY, OR (III) THAT THIS DOCUMENT IS SUITABLE TO ANY PARTICULAR USER'S CIRCUMSTANCE; OR

(B) ASSUMES RESPONSIBILITY FOR ANY DAMAGES OR OTHER LIABILITY WHATSOEVER (INCLUDING ANY CONSEQUENTIAL DAMAGES, EVEN IF EPRI OR ANY EPRI REPRESENTATIVE HAS BEEN ADVISED OF THE POSSIBILITY OF SUCH DAMAGES) RESULTING FROM YOUR SELECTION OR USE OF THIS DOCUMENT OR ANY INFORMATION, APPARATUS, METHOD, PROCESS, OR SIMILAR ITEM DISCLOSED IN THIS DOCUMENT.

ORGANIZATION(S) THAT PREPARED THIS DOCUMENT

**GeoSyntec Consultants, Inc.**  
**Arizona State University**

## **ORDERING INFORMATION**

Requests for copies of this report should be directed to EPRI Orders and Conferences, 1355 Willow Way, Suite 278, Concord, CA 94520, (800) 313-3774, press 2 or internally x5379, (925) 609-9169, (925) 609-1310 (fax).

Electric Power Research Institute and EPRI are registered service marks of the Electric Power Research Institute, Inc.

Copyright © 2005 Electric Power Research Institute, Inc. All rights reserved.

# CITATIONS

---

This report was prepared by

GeoSyntec Consultants, Inc.  
130 Research Lane, Suite 2  
Guelph, Ontario  
Canada N1G 5G3

and

924 Anacapa Street, Suite 4A  
Santa Barbara, CA 93101-2177

Principal Investigators

T. McAlary

R. Ettinger

Department of Civil and Environmental Engineering  
Arizona State University  
Tempe, AZ 85287

Principal Investigator

P. Johnson

This report describes research sponsored by EPRI, Alliant Energy Corporation, Consolidated Edison Co. of New York, Inc., Exelon Corporation, First Energy Corp., Honeywell, Inc., KeySpan Energy, New Your State Electric & Gas Corp., NiSource Inc., Orange & Rockland Utilities, Inc., PPL Services Corp., Public Service Electric & Gas Co., Rochester Gas & Electric Corp, and We Energies.

The report is a corporate document that should be cited in the literature in the following manner:

*Reference Handbook for Site-Specific Assessment of Subsurface Vapor Intrusion to Indoor Air*, EPRI, Palo Alto, CA: 2005. 1008492.



# REPORT SUMMARY

---

Subsurface vapor intrusion is only one of several possible sources for volatile and semi-volatile chemicals in indoor air. This report provides guidance on the site-specific assessment of the significance of subsurface vapor intrusion into indoor air. Topics covered include theoretical considerations, sampling and analysis considerations, recommended strategies and procedures, interpretive tools, mitigation measures, and suggestions for future research. This document reflects a comprehensive understanding of the current scientific knowledge in this field.

## **Background**

Sub-surface vapor intrusion to indoor air is a potential pathway for human exposure at sites impacted by volatile and semi-volatile chemicals. This pathway has attracted increasing attention in the past few years as a result of several case studies, multiple new regulatory guidance documents, and heightened public awareness. At sites where vapor intrusion is occurring at levels that pose an unacceptable risk to the health of building occupants, the pathway can be controlled by a variety of technologies similar to radon mitigation options. However, it can be very difficult to determine whether subsurface vapor intrusion is occurring or the extent to which controls are needed. Indoor air target concentrations are often very near the detection limits of laboratory analyses; and a myriad of chemicals are typically present in indoor air as a result of consumer products, building materials, and even outdoor air. Background and ambient air quality alone can pose potentially unacceptable risks for some compounds in some locations. It is therefore important to be able to distinguish these contributions from subsurface vapor intrusion. Otherwise control systems may be implemented without just cause, and unjustified liabilities may accrue. To date, regulatory guidance documents for subsurface vapor intrusion assessment generally require screening of groundwater, soil gas, or indoor air concentrations using conservative media-specific concentrations, derived using cautious estimates of the extent to which subsurface vapors may enter a building. Where site-specific data exceed screening concentrations, further assessment or proactive mitigation are generally required. Guidance for approaches, strategies, technologies, and protocols for conducting a site-specific assessment is currently not very comprehensive.

## **Objectives**

To summarize the current state-of-knowledge of subsurface vapor intrusion and provide suggestions for site-specific assessment of vapor intrusion.

## **Approach**

The project team drew on their collective experience and recent publications, presentations, and regulatory guidance to produce a compilation of information on this topic. Members of the EPRI Vapor Intrusion Interest Group reviewed a comprehensive outline of the handbook for scope and organization of the content and also reviewed a draft of the document for consideration of

alternate views and opinions. The project team solicited specialists in laboratory analysis and risk assessment for contributions in their respective areas of expertise. For the appendices, the team compiled a comprehensive list of references and a list of practical tools and procedures from various sources to provide a useful resource for project managers, field technicians, regulators, and researchers.

## **Results**

This handbook offers one of the most comprehensive compilations of technical information, practical experience, strategy, procedures, and resources available to date on the subject of subsurface vapor intrusion. To the extent practical, pros and cons are discussed for all topic areas, as well as conditions that might favor different strategies, methods, or mitigation measures. Site conditions are so variable that no universally applicable generic approach will be cost effective and minimize the risk of false negative and false positive determinations in all cases. Therefore, this handbook has been designed to allow sufficient flexibility for the practitioner to customize the assessment process to site-specific conditions. Where practicable and appropriate, sampling methods have been specified in sufficient detail to minimize any avoidable artifacts of data bias and variability. The consortium of sponsors for the preparation of this handbook are responsible for environmental issues at many former Manufactured Gas Plant (MGP) sites, so information specific to these types of sites has been added where possible. However, equal importance was given to chlorinated chemicals and petroleum hydrocarbons, so the document should be useful to investigators in all these areas.

Much can still be learned in the area of subsurface vapor intrusion, and future research and development may render parts of this handbook obsolete, so it should be considered as work-in-progress. Nevertheless, a growing number of site-specific assessments are being performed; and this handbook provides up-to-date information that should be relevant and helpful for increasing the accuracy and consistency with which the assessments are conducted.

## **EPRI Perspective**

EPRI believes the information in this handbook may be useful to responsible parties, their consultants, regulators, and other stakeholders in better understanding subsurface vapor intrusion, improving the characterization of the pathway at sites of varying conditions, minimizing the complexity of discerning background and ambient air contributions, assessing inhalation risks, and selecting appropriate mitigation measures. The procedures the handbook recommends may help minimize data variability; the interpretive tools it provides may improve the consistency of determinations; and its comprehensiveness may provide adequate flexibility to accommodate a wide variety of site-specific conditions.

## **Keywords**

Subsurface vapor intrusion to indoor air (SVI-IA)  
Site-specific assessment  
Subsurface to indoor air attenuation factor  
Indoor Air Quality  
MGP and Contaminated Sites  
Chlorinated Chemicals and Volatile Organics (VOCs)



# ABSTRACT

---

Sub-surface vapor intrusion to indoor air is a potential pathway for human exposure at sites impacted by volatile and semi-volatile chemicals; but it can be very difficult to determine whether subsurface vapor intrusion is occurring or the extent to which controls are needed, especially since many chemicals are typically present in indoor air as a result of consumer products, building materials, and even outdoor air. To provide a reference handbook on the site-specific assessment of subsurface vapor intrusion into indoor air, EPRI's Vapor Intrusion Interest Group commissioned this Reference Handbook from a team of experts with extensive experience in the study of subsurface vapor intrusion to indoor air. The handbook compiles information on theory, strategy, procedures, interpretive tools, and mitigation measures, along with several other useful and practical resources into a single comprehensive document on the subject. This handbook may be useful for those conducting, reviewing, or responsible for site-specific assessments of subsurface vapor intrusion. It may help to reduce data variability, improve consistency of interpretations, and resolve complex background and ambient air quality interferences.



## ACKNOWLEDGMENTS

The authors would like to acknowledge Mr. Ashok Jain of EPRI for championing this project and this Program Area within EPRI and the industry. They would also like to thank the members of the EPRI Vapor Intrusion Interest Group who cosponsored this work and participated in the review, specifically:

Name	Company
Ted Leissing, Tracey Bell, Larry Liebs, Richard Schmitz	KeySpan Energy
Tracy Blazicek, Allen Peterson, Joe Simone	New York State Electric & Gas Corp.
Joe Ferry, Bob Cleary, Marc Okin	NiSource Inc.
Benny Dehghi, Troy Meyer	Honeywell, Inc.
Bryan Sladky, Allan Fernandes, Peter McCauley	Exelon Corporation
Greg Taylor, Bruce Greer, Dean Hargens, Jill Stevens	Alliant Energy Corporation
Yelena Skorobogatov, Chris Hughes, Eddy Louie, Richard Rienzo, Neil O'Halloran	Consolidated Edison Co. of New York, Inc.
Kevin Hylton	Rochester Gas & Electric Corp.
Ash Jain	EPRI, Palo Alto, CA / Bridgewater, NJ
Colin Sweeney, Frank Lawson	First Energy Corporation
Jim Lingle	We Energies
Maribeth McCormick, Brian Quilla	Orange & Rockland Utilities, Inc. (a Consolidated Edison company)
Bruce Preston, Wayne Wittman	Public Service Electric & Gas Co.
Craig Shamory, Mike Hasel	PPL Services Corp.



# CONTENTS

---

<b>1 INTRODUCTION .....</b>	<b>1-1</b>
1.1 Scope .....	1-2
1.2 Overview of Current Regulatory Guidance.....	1-3
1.3 Definition of the Attenuation Factor .....	1-5
1.4 Structure and Content of this Handbook .....	1-6
<b>2 THEORETICAL CONSIDERATIONS .....</b>	<b>2-1</b>
2.1 Background and Ambient Air Quality Concerns .....	2-1
2.1.1 Indoor Air Sources .....	2-1
2.1.2 Outdoor Air Sources .....	2-2
2.1.3 Indoor Air Background Concentrations.....	2-3
2.1.4 Options for Assessing Indoor Air Background Concentrations.....	2-4
2.2 Conceptual Models.....	2-5
2.2.1 Source .....	2-6
2.2.2 Pathway .....	2-7
2.2.3 Receptor .....	2-13
2.3 Fate and Transport Mechanisms.....	2-14
2.3.1 Vapor Diffusion in Soils .....	2-14
2.3.2 Phase Partitioning .....	2-15
2.3.3 Soil Gas Advection .....	2-16
2.3.4 Building Characteristics .....	2-17
2.3.5 Effects of Biodegradation .....	2-17
2.4 Considerations Specific to Different Families of Chemicals .....	2-21
2.4.1 Petroleum Fuels: Gasoline, Diesel, Heating Oil, Jet Fuel, etc.....	2-21
2.4.2 Chlorinated Solvents .....	2-22
2.4.3 Manufactured Gas Plant (MGP) Wastes and Coal Tar .....	2-22
2.4.4 Other High Molecular Weight Organic Compounds .....	2-24
2.4.5 Metals/Inorganics .....	2-24

---

2.4.6 Methane.....	2-24
<b>3 SAMPLING AND ANALYSIS CONSIDERATIONS.....</b>	<b>3-1</b>
3.1 Context of Sampling and Analysis Challenges.....	3-1
3.2 Pros and Cons of Sampling for Various Media .....	3-2
3.2.1 Shallow Groundwater .....	3-4
3.2.2 Sub-Slab Soil Gas .....	3-5
3.2.3 Soil Gas Samples Collected Adjacent to a Building .....	3-6
3.2.4 Indoor air .....	3-8
3.2.5 Soil Sampling.....	3-8
3.3 Alternatives to Conventional Sampling and Analysis .....	3-9
3.3.1 Collection of Soil Gas Samples From Groundwater Wells .....	3-9
3.3.2 Passive Soil Gas Sampling .....	3-9
3.3.3 Flux Chambers .....	3-9
3.3.4 Building Pressure/Ventilation Testing.....	3-10
3.3.5 Respirometry Testing .....	3-11
3.3.6 High Purge Volume Sampling .....	3-12
3.3.7 Indoor air Sampling With and Without Subslab De-pressurization.....	3-12
3.4 Multiple Lines of Evidence.....	3-13
3.5 Analytical Methods .....	3-13
3.5.1 Laboratory Challenges (courtesy of Air Toxics Ltd.).....	3-16
3.5.2 Field Screening Considerations.....	3-20
PIDs and FIDs for VOC Screening .....	3-20
Z-Nose™ .....	3-21
Landfill Gas Meters for O <sub>2</sub> , CO <sub>2</sub> and CH <sub>4</sub> .....	3-22
SF6 and He Meters.....	3-22
Mobile Laboratories .....	3-22
Mercury Meters.....	3-23
TAGA .....	3-23
Portable PTR-MS.....	3-23
<b>4 MATHEMATICAL MODELING.....</b>	<b>4-1</b>
<b>5 STRATEGY FOR PHASED APPROACH TO SITE-SPECIFIC ASSESSMENT.....</b>	<b>5-1</b>
5.1 Planning .....	5-1

---

5.2 Focused Investigations.....	5-1
5.3 External Investigations .....	5-2
5.4 Internal Investigations .....	5-3
<b>6 SUGGESTED METHODS FOR DATA COLLECTION .....</b>	<b>6-1</b>
6.1 Soil Gas Sampling and Pneumatic Testing.....	6-1
6.1.1 Driven vs Drilled Probes .....	6-2
6.1.2 Soil Gas Probe Diameter.....	6-3
6.1.3 Soil Gas Probe Materials.....	6-4
6.1.4 Use of Water Table Monitoring Wells as Soil Gas Probes .....	6-5
6.1.5 Screen Length .....	6-6
6.1.6 Options for Vertical Profiling .....	6-6
6.1.7 Probe Development.....	6-7
6.1.8 Leak Testing .....	6-7
6.1.9 Purging and Sampling .....	6-8
6.2 Sub-Slab Sampling.....	6-9
6.3 Groundwater Sampling.....	6-11
6.4 Indoor Air Sampling.....	6-12
6.5 Outdoor Air Sampling.....	6-14
6.6 Meteorological Monitoring .....	6-15
<b>7 DATA ANALYSIS AND INTERPRETATION .....</b>	<b>7-1</b>
7.1 Data Organization and Review.....	7-1
7.1.1 Data Organization.....	7-1
7.1.2 Data Quality Review .....	7-2
7.2 Data Analysis .....	7-4
7.2.1 Comparison of Indoor Air to Outdoor Air and Background .....	7-4
7.2.2 Consistency in Chemical Concentrations: Subsurface to Indoor.....	7-5
7.2.3 Comparison Between Measurements and Modeling.....	7-6
7.2.4 Use of Specific Chemicals as Tracers.....	7-7
7.2.5 Spatial and Temporal Correlations .....	7-9
7.2.6 Causal Relationships.....	7-9
7.2.7 Ratios of Two or More Compounds.....	7-10
7.2.8 Interpolation and Extrapolation.....	7-12
7.3 Risk Assessment and Risk Management.....	7-13

---

<b>8 MITIGATION</b> .....	<b>8-1</b>
8.1 Methods/Technologies for Existing Buildings.....	8-1
8.1.1 Sub-Slab De-Pressurization .....	8-1
8.1.2 Soil Vacuum Extraction .....	8-3
8.1.3 Building Pressurization .....	8-3
8.1.4 Sealing Cracks, Sumps, Sewers, and Other Potential Conduits .....	8-4
8.1.5 Air Filtration .....	8-5
8.2 Methods/Technologies for Future Buildings.....	8-5
8.2.1 Intrinsically Safe Building Design .....	8-6
8.2.2 Vapor Barriers and Ventilation Layers.....	8-6
8.2.3 Excavation of Contaminated Soil and Replacement with Clean Fill .....	8-8
8.3 Administrative Controls .....	8-8
8.4 Monitoring .....	8-8
<b>9 RESEARCH NEEDS</b> .....	<b>9-1</b>
9.1 Indoor Air Sampling With and Without Pressure Changes.....	9-1
9.2 Headspace Screening for Very Low Permeability Soils .....	9-2
9.3 Use of Naturally Occurring Radon as a Tracer .....	9-2
9.4 Longer Term Integrated Average Samples .....	9-4
9.5 Mathematical Modeling .....	9-4
9.6 Intrinsic Aerobic Biodegradation.....	9-4
9.7 Forensics.....	9-4
9.8 Background .....	9-4
<b>10 REFERENCES</b> .....	<b>10-1</b>
<b>A INDOOR AIR QUALITY BUILDING SURVEY</b> .....	<b>A-1</b>
<b>B NEW JERSEY DEP INSTRUCTIONS FOR OCCUPANTS</b> .....	<b>B-1</b>
<b>C INDOOR AIR QUALITY SAMPLING FORM</b> .....	<b>C-1</b>
<b>D SUGGESTED OPERATING PROCEDURE: SOIL GAS PROBE INSTALLATION</b> .....	<b>D-1</b>
D.1 Introduction and Overview .....	D-1
D.2 Permits and Utility Clearances.....	D-2
D.3 Drilling/Coring .....	D-2



D.4 Geological Logging.....	D-3
D.5 Probe Design and Assembly .....	D-4
D.5.1 PVC Well Screen and Riser Pipe.....	D-6
D.5.2 HDPE, Teflon™ or Nylon tubing .....	D-6
D.5.3 Stainless Steel Screens .....	D-7
D.6 Backfilling.....	D-7
D.7 Protective Casings.....	D-8
D.8 Development and Equilibration.....	D-9
D.9 Testing of Seals between Multi-Level Probes.....	D-9
D.10 Documentation.....	D-10
D.11 References and Additional Reading .....	D-10
D.12 Attachment 1: Recommended Equipment.....	D-12
<b>E SUGGESTED OPERATING PROCEDURE: SOIL GAS SAMPLE COLLECTION.....</b>	<b>E-1</b>
E.1 Introduction .....	E-1
E.2 Static Pressure or Vacuum .....	E-1
E.3 Leak Checks .....	E-2
E.4 Flow and Vacuum Check.....	E-3
E.5 Soil Gas Probe Purging .....	E-5
E.6 Field Screening.....	E-7
E.7 Collection of Samples for Laboratory Analysis .....	E-8
E.7.1 Summa Canisters.....	E-8
E.7.2 ATD Tubes.....	E-9
E.8 Chain of Custody and Sample Handling.....	E-10
E.9 Field QC Samples for Soil Gas Sample Collection.....	E-10
E.9 Equipment Cleaning.....	E-11
E.10 Documentation.....	E-12
E.11 References and Suggested Reading.....	E-12
E.12 Attachment 1: Recommended Equipment .....	E-14
<b>F SUGGESTED OPERATING PROCEDURE: SUB-SLAB SOIL GAS MONITORING.....</b>	<b>F-1</b>
F.1 Overview .....	F-1
F.2 Probe Design and Installation .....	F-1
F.2.1 Type 1 Probes.....	F-2
F.2.2 Type 2 Probes.....	F-3

F.3 Measurement of Sub-slab Gauge Pressure/Vacuum.....	F-4
F.4 Flow and Vacuum Check .....	F-4
F.5 Purging and Sample Collection.....	F-6
F.5.1 Preparation.....	F-7
F.5.2 Purging and Field Screening .....	F-9
F.5.3 Summa Canister Sample Collection.....	F-10
F.5.4 ATD Tube Sample Collection .....	F-11
F.6. Chain of Custody and Sample Handling .....	F-11
F.7 Field QC Samples for Soil Gas Sample Collection .....	F-12
F.8 Equipment Cleaning.....	F-13
F.9 Documentation.....	F-13
F.10 References and Suggested Reading .....	F-14
F.11 Attachment 1: Recommended Equipment .....	F-16

**G GUIDE TO AIR SAMPLING AND ANALYSIS: CANISTERS AND TEDLAR™ BAGS ..... G-1**

**H QUANTITATIVE HUMAN HEALTH RISK ASSESSMENT FOR THE SUBSURFACE VAPOR INTRUSION PATHWAY ..... H-1**

H.1 Hazard Identification.....	H-1
H.1.1 Check for Imminent Threats to Human Health.....	H-1
H.1.2 Develop a Site Conceptual Model.....	H-2
H.1.3 Evaluate Data Quality .....	H-2
H.1.4 Identify Chemicals of Concern .....	H-2
H.2 Exposure Assessment.....	H-2
H.2.1 Exposure Point Concentrations .....	H-3
H.2.2 Average Daily Exposure for Inhalation of Vapors .....	H-3
H.3 Dose-Response Assessment .....	H-4
H.3.1 Carcinogenic Chemicals .....	H-5
H.3.2 Noncarcinogenic Chemicals .....	H-5
H.3.3 COCs with No Published Toxicity Values .....	H-5
H.3.4 Selected Chemicals Commonly Detected at MGP Sites .....	H-5
H.3.4.1 Naphthalene.....	H-6
H.3.4.2 PAHs .....	H-6
H.3.4.3 Petroleum Fractions .....	H-7
H.4 Risk Characterization.....	H-7

---

H.4.1 Noncancer Hazard .....	H-7
H.4.1.1 Target Organ Hazard Indices Division .....	H-8
H.4.1.2 SVI Contribution to Noncancer Hazard .....	H-9
H.4.2 Cancer Risk .....	H-9
H.5 Remedial Goals .....	H-10
H.5.1 General Approach for Estimating Risk-Based Concentrations (RBCs) .....	H-10
H.5.2 Calculating Indoor Air RBCs .....	H-10
H.5.3 Calculating Soil Gas RBCs .....	H-11
H.5.4 Calculating Groundwater RBCs .....	H-12
H.6 References .....	H-13



# LIST OF FIGURES

---

Figure 1-1 OSWER Flow Chart for Site-Specific Assessment (EPA, 2002) .....	1-4
Figure 2-1 Compounds Potentially Contributed from Indoor Sources (Hers et al., 2001).....	2-1
Figure 2-2 Examples of Concentrations of VOCs Measured in Outdoor Air (in ppbv) .....	2-2
Figure 2-3 Background Ranges from Various Published Studies ( $\mu\text{g}/\text{m}^3$ ) .....	2-3
Figure 2-4 Concentrations of VOCs before and after Sub-slab Venting (Folkes, 2000) .....	2-5
Figure 2-5 Simple Conceptual Model of Vapor Intrusion (EQM, 2000).....	2-6
Figure 2-6 Lateral Diffusion of Vapors Through the Unsaturated Zone (schematic).....	2-8
Figure 2-7 Vapor Transport Through Preferential Pathways (schematic).....	2-8
Figure 2-8 Vapor Intrusion in a Building with a Wet Basement (schematic) .....	2-9
Figure 2-9 Fresh Water Lens as a Barrier to Volatilization from Groundwater (schematic).....	2-10
Figure 2-10 Detailed Conceptual Model of Vapor Intrusion Properties.....	2-11
Figure 2-11 Effect of Falling Water Table on Off-Gassing from Groundwater (schematic).....	2-16
Figure 2-12 Model Domain and General Conditions for 3-D Vapor Intrusion Model (Johnson and Abreu, 2003).....	2-18
Figure 2-13 Modeled subsurface $\text{O}_2$ and VOC distribution with biodegradation – shallow source (Johnson and Abreu, 2003) .....	2-19
Figure 2-14 Modeled subsurface $\text{O}_2$ and VOC distribution with biodegradation – intermediate depth source (Johnson and Abreu, 2003) .....	2-20
Figure 2-15 Modeled subsurface $\text{O}_2$ and VOC distribution with biodegradation – deep source (Johnson and Abreu, 2003) .....	2-20
Figure 2-16 Compounds that may be useful for distinguishing between various hydrocarbon mixtures (Berry-Spark, et. al., 2004). .....	2-23
Figure 3-1 Effect of Well Screen Position and Borehole Dilution (Johnson, 2002) .....	3-5
Figure 3-2 Oxygen and Hydrocarbon Vapor Distribution and Comparison Between Near- Slab and Sub-Slab Sampling (Johnson and Abreu, 2003).....	3-7
Figure 3-3 Equipment for Pressure/Ventilation Testing (McAlary et. al., 2002) .....	3-11
Figure 3-4 Chromatographs for laboratory analyses by Methods TO-15 and 8260B .....	3-17
Figure 5-1 Generic Strategy for Site-Specific Assessment of Subsurface Vapor Intrusion .....	5-5
Figure 5-2 Details of Scope Elements to be Considered in Generic Strategy .....	5-6
Figure 6-1 Example Construction Details for Groundwater and Soil Gas Sampling.....	6-6
Figure 6-2 Recommended Design for Sub-Slab Soil Gas Probes (EPA, 2004).....	6-10
Figure 7-1 Plot of Attenuation Factor vs Soil Gas Concentration (Ettinger, 2003).....	7-6

---

Figure 7-2 Correlation Between Groundwater and Indoor Air Concentrations for 11DCE (Folkes, 2000) .....	7-8
Figure 7-3 Comparison of Relative Concentrations of Two Compounds (Berry-Spark et. al, 2004) .....	7-11
Figure 7-4 Multi-linear Diagram for comparison of different constituents in fuel mixtures (Kaplan, et al., 1997).....	7-12
Figure 8-1 Typical Design for a Sub-Slab Venting System (schematic) .....	8-2
Figure 8-2 Performance Data from a Sub-Slab Depressurization System (Folkes, 2000).....	8-2
Figure 8-3 Monitoring Air Flow to Balance Pressure within a Building .....	8-4
Figure 8-4 Use of Sealants to prevent Vapor Intrusion Through Cracks .....	8-5
Figure 8-5 Multiple Layers for Venting Being Installed Prior to Construction.....	8-7
Figure 8-6 Gravel Being Placed over Geomembrane Prior to Concrete Slab .....	8-7
Figure 9-1 Radon Electret (epa.radon.gov) .....	9-3
Figure 9-2 Map of Radon Concentrations (epa.radon.gov) .....	9-3
Figure D-1 Options For Soil Gas Probe Designs: A) Single Probe, B) Multi-Level Probes, and C) Combination Deep Soil Gas and Shallow Groundwater Probe.....	D-5
Figure E-1 Soil Gas Sampling Apparatus .....	E-6
Figure F-1 Sub-Slab Probe .....	F-17
Figure F-2 Sub-Slab Vapor Probe (Type 2) .....	F-18
Figure F-3 Soil Gas Sampling Apparatus .....	F-19

## LIST OF TABLES

---

Table 3-1 Benefits and Limitations of Samples from Various Media .....	3-3
--	-----





# 1

## INTRODUCTION

---

This document provides guidance for the assessment of subsurface vapor intrusion to indoor air (vapor intrusion), with particular emphasis on considerations related to former manufactured gas plant (MGP) sites, although the contents are generally applicable to other sites and classes of compounds. Vapor intrusion has been studied for decades, but has recently received increased regulatory interest, particularly for volatile organic compounds (VOCs) and some semi-volatile organic compounds (SVOCs). The United States Environmental Protection Agency (US EPA) and several States have prepared vapor intrusion guidance documents, many of which are still in draft form at the time this Handbook was published. The regulatory guidance documents typically include a screening process based on conservative assumptions to minimize the risk of a false negative determination (i.e., failing to adequately identify a risk). Consequently, a significant number of sites are likely to require site-specific assessments, which are challenging because of the general lack of experience and detailed information on conducting these evaluations as well as extremely low target breathing zone concentrations for many common VOCs. These target concentrations are often similar to background air quality and near or below typical laboratory detection limits for many compounds. Therefore, distinguishing the contribution of vapors from the subsurface is often very difficult.

The goals of this document are to:

- Aid practitioners conducting site-specific assessments of vapor intrusion
- Summarize the current information on vapor intrusion, including research needs
- Identify common sources of bias, variability, and interpretive challenges
- Provide methods for sampling designed to minimize bias and variability
- Identify interpretive tools to assist in data analysis, especially discriminating the effects of subsurface vapors from background sources
- Provide easy access to more information via a comprehensive reference list
- Provide specific information applicable at former MGP/coal tar sites
- Provide a description of management options and logic for selection

This document is not intended to provide a “one-size-fits-all” approach to vapor intrusion assessments, but rather a framework of logic and a toolbox of techniques that can be used to address individual site conditions. In many cases, multiple lines of evidence may be required to provide an assessment that distinguishes the contributions of subsurface vapors from background (indoor) and ambient (outdoor) sources. Professional judgment is still essential to developing an appropriate scope of work to clearly resolve the low levels of vapor intrusion established as targets in current regulatory guidance. The theoretical information and conceptual model

discussions in this document are intended to provide the practitioner with sufficient background to develop a site-specific assessment strategy. The intention is to provide a standardized approach, but also provide sufficient information to help the practitioner adjust as necessary to site-specific conditions, while maintaining data quality, consistency, and a strong theoretical foundation for the study. At the time of preparation of this Handbook, there are differing opinions on a number of subjects, without published studies to clearly document which opinion is correct in which cases. Therefore, opposing opinions are presented for consideration, as well as the authors' suggested approaches for resolving the potential for subsurface vapor intrusion as clearly and as directly as possible.

This document should be considered a guide, and methods discussed herein are recommended or suggested practices and are not intended to establish a binding standard. For simplicity, caveats have not been excessively repeated, but the entire document is intended to imply "to the extent practical, relevant and appropriate" for each suggestion of what "should" be done. Reference to specific products or practices does not constitute an endorsement by EPRI, its cosponsors, or its agents. In some jurisdictions, there are regulatory requirements that may conflict with practices described in this document, so the user is advised to consider any such requirements in preparing for a site-specific assessment. Much of the information gained in recent years about subsurface vapor intrusion has been published in non-peer reviewed materials and some aspects are still in early stages of research. Accordingly, interpretations based on these sources may change with time, as new information becomes available.

## **1.1 Scope**

This document provides a summary of pertinent information and reference to key resources on:

- Background indoor and outdoor air quality
- Conceptual Models of subsurface vapor transport and intrusion
- Theory of subsurface vapor transport mechanisms
- Sampling and analytical considerations
- Modeling
- Strategy for a phased approach to vapor transport evaluation
- Suggested methods for data collection
- Data interpretation
- Management and mitigation options
- Data gaps and research needs

It also provides detailed methods for field data collection, designed to minimize data biases, foster consistency between practitioners, and promote a comprehensive approach to documentation.

## 1.2 Overview of Current Regulatory Guidance

The US EPA Office of Solid Waste and Emergency Response (OSWER) issued a draft Guidance for Evaluating the Vapor Intrusion to Indoor Air Pathway from Groundwater and Soils (“the draft OSWER Guidance”, EPA, 2002). The draft OSWER Guidance is intended to be applied at all sites administered under the Resource Conservation and Recovery Act (RCRA), the Comprehensive Environmental Response, Compensation and Liability Act (CERCLA), and Brownfields programs, except where States are the lead agencies and have their own vapor intrusion guidance. EPA does not currently require use of the draft OSWER Guidance at sites administered under the UST Program. However, the vapor intrusion pathway is evaluated at many UST sites through state risk-based regulatory programs.

The draft OSWER Guidance recommends a three-tiered assessment approach for the vapor intrusion pathway:

- Tier 1 – A primary screen is conducted to determine whether general site conditions (e.g., constituents of concern, distance to receptors, conditions requiring immediate action) warrant further evaluation of the potential pathway.
- Tier 2 – Soil gas and/or groundwater concentrations are compared with screening values that are selected based on commonly available site information (e.g., chemical analytical data, depth to contamination, soil type). Where groundwater and soil gas concentrations are lower than these conservative screening levels, no further assessment is required.
- Tier 3 – Site-specific pathway assessment including additional data collection or more site-specific modeling, as needed to determine whether vapor intrusion poses unacceptable risks.

The process for a site-specific assessment in the draft OSWER Guidance is shown on Figure 1-1. This may change, as the EPA is contemplating revising the OSWER Guidance, nevertheless, currently at a minimum, sub-slab soil gas data are required for site-specific assessments (excluding Environmental Indicator determinations under RCRA). The pathway is considered incomplete if sub-slab soil gas concentrations are lower than screening levels; however, outdoor air concentrations of some compounds in some locations are higher than the sub-slab screening concentrations, so there is a high risk of a false-positive determination using the current draft OSWER Guidance.

Background interferences may affect the screening process. For example, the target sub-slab soil gas concentration for benzene at the incremental cancer risk level of  $10^{-6}$  is  $3.1 \mu\text{g}/\text{m}^3$  (OSWER, Table 2c), which is lower than some published background indoor air concentrations (e.g.  $17 \mu\text{g}/\text{m}^3$ : Shah & H. Singh, 1988), and not even a factor of 2 above the standard analytical reporting limit for laboratory analysis by EPA Method TO-15. Therefore, indoor air samples will often be required, even if the benzene in the sub-slab sample originated from an indoor source. The target indoor air concentration for the  $10^{-6}$  risk level ( $0.31 \mu\text{g}/\text{m}^3$ ) is lower than some published background outdoor air concentrations, especially in areas of heavy automotive traffic, which may indicate an apparent risk, but not be related to subsurface vapor intrusion at all. Similar arguments can be made for other chemicals, so the recommended approach for site-specific screening in the draft OSWER guidance will lead to challenges associated with discerning background contributions from subsurface vapor intrusion.

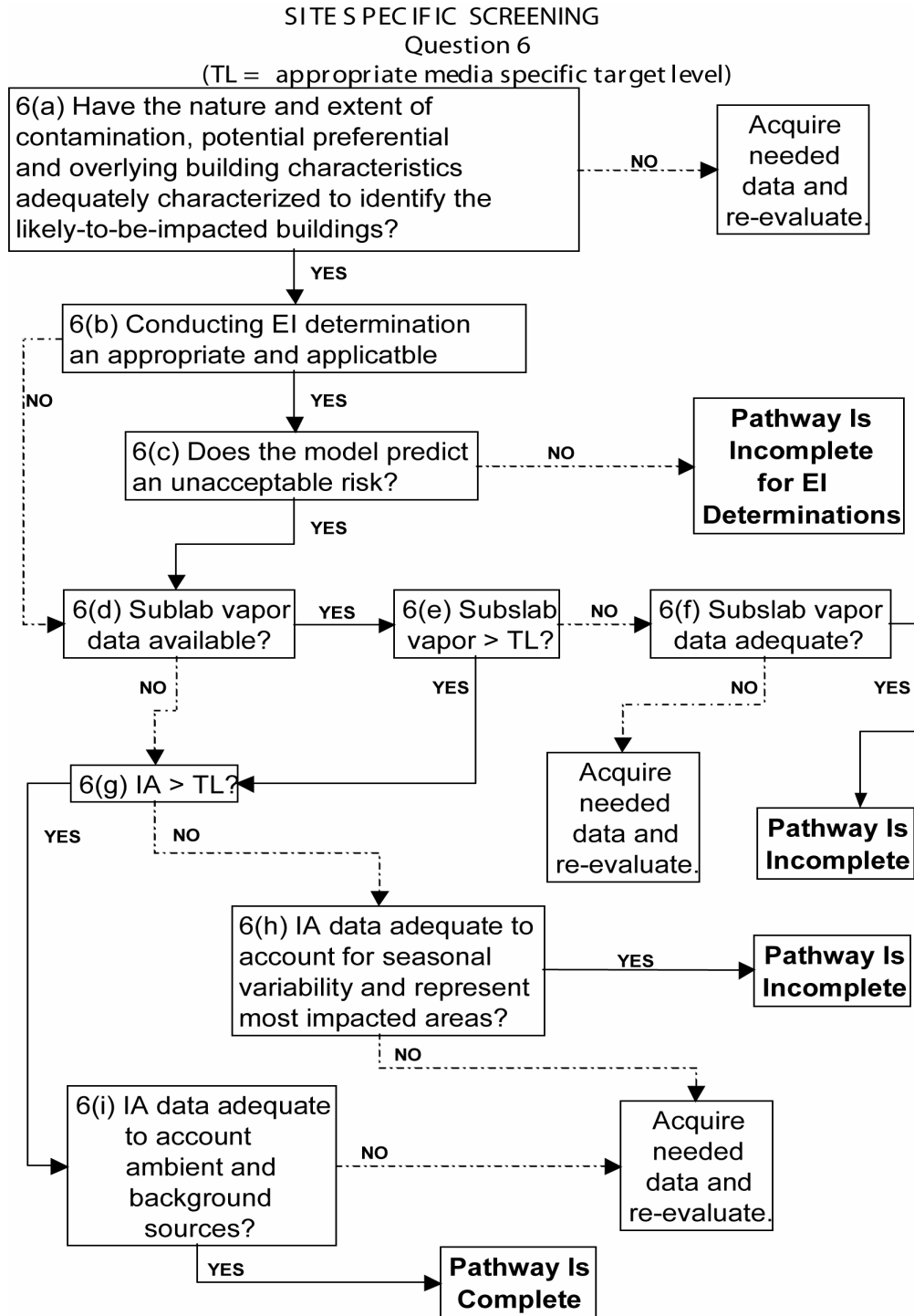

**Figure 1-1  
OSWER Flow Chart for Site-Specific Assessment (EPA, 2002)**

In the above figure, EI means Environmental Indicator under RCRA, IA means indoor air, and TL means target level. Question 6b) was inadvertently truncated in the draft OSWER Guidance, and should read “Conducting EI determination using an appropriate and applicable model?”

When EPRI published this document, public comments on the draft OSWER Guidance had been received and a response to technical comments had been prepared, but not yet posted to the EPA web-site. EPA held workshops at the American Environmental Health Sciences (AEHS) conferences in San Diego in March 2004 and Amherst in October 2004 to solicit input on the generic subsurface to indoor air attenuation coefficients (see Section 1.3) and the modeled attenuation factors of the guidance, respectively. EPA has established an on-line database through Research Triangle International (RTI) to compile information regarding empirical attenuation coefficients as more and more site-specific assessments are conducted. The available data compiled to date shows a significant amount of variability (Dawson, 2004), and it is not yet clear to what extent the variability is attributable to background sources, variability in sampling methods, sampling bias, site characteristics, or other potential influences. EPA has expressed an intent to revising the draft OSWER guidance as appropriate as information becomes available to provide technical support for such changes.

Sites administered under the Underground Storage Tanks (UST) program are still evaluated using the Risk-Based Corrective Action (RBCA) process (ASTM, 1995), unless a state-specific guidance for vapor intrusion is available. The technical content of this handbook was designed to assist vapor intrusion assessments, regardless of the administrative jurisdiction for any particular site.

Several states have their own existing or draft policies, guidance, and/or regulations for screening and/or assessing the vapor intrusion pathway, including Alaska, California, Colorado, Connecticut, Illinois, Indiana, Kansas, Louisiana, Maine, Massachusetts, Michigan, New Hampshire, New Jersey, New York, Ohio, Oregon, Pennsylvania, Texas, Utah, Washington, and Wisconsin. The rate at which these documents are issued and revised would render any comprehensive review outdated in short order, so no detailed review of individual State guidance is included in this document. However, two recently published documents are relatively comprehensive and therefore worthy of specific mention: California Department of Toxic Substances Control Guidance for the Evaluation and Mitigation of Subsurface Vapor Intrusion to Indoor Air (DTSC, 2004) and Health Canada Soil Vapour Intrusion Guidance for Health Canada Screening Level Risk Assessment (Health Canada, 2004). A recent publication by the American Petroleum Institute on Collecting and Interpreting Soil Gas Data from the Vadose Zone (API, 2004) also provides a comprehensive discussion of the use of soil gas data in vapor intrusion assessments at petroleum sites.

### 1.3 Definition of the Attenuation Factor

The subsurface to indoor air attenuation factor ( $\alpha$ ) is commonly used to characterize the magnitude of subsurface vapor intrusion. The attenuation factor is defined (Johnson and Ettinger, 1991) as:

$$\alpha = \frac{C_{build}}{C_{source}}$$

where  $C_{build}$  is the concentration of a vapor inside the building and  $C_{source}$  is the vapor concentration at a specified depth below the building. Smaller numbers in this formulation

indicate more attenuation, or less vapor intrusion for a fixed source vapor concentration. The average attenuation factor from published radon studies is about 0.0016 (Little, et al 1992). The draft OSWER Guidance currently assumes the following default attenuation factors:

sub-slab to indoor air:	$\alpha = 0.1$
soil gas to indoor air (>5 ft bgs):	$\alpha = 0.01$
groundwater to indoor air:	$\alpha = 0.001$

The empirical data used to select these values is constantly expanding, and revisions to these values are currently being considered by EPA (Dawson, 2004), particularly the sub-slab to indoor air attenuation factor, which is likely to be revised to 0.02, or perhaps 0.01 (DTSC, 2004).

## **1.4 Structure and Content of this Handbook**

This Handbook presents comprehensive general information and theoretical considerations on vapor transport and assessment approaches, followed by more specific details and recommended procedures in later chapters and appendices. Chapter 2 describes the development of a conceptual model and vapor transport theory. Chapter 3 describes considerations for sampling and analysis, which are intended to help the practitioner understand the rationale for the suggested protocols, and provide sufficient knowledge to support technically defensible alternatives where site-specific conditions dictate. Chapter 4 describes the use of mathematical modeling as an assessment tool. Chapters 5 and 6 describe the recommended strategy and methods for a site-specific assessment. Chapter 7 described data interpretation and analysis tools. Chapter 8 describes mitigation methods. Chapter 9 describes future research needs. A variety of resource materials are provided in the Appendices, including a survey form, instructions to building occupants during indoor air monitoring, and sampling protocols, forms and guides.

# 2

## THEORETICAL CONSIDERATIONS

### 2.1 Background and Ambient Air Quality Concerns

When collecting indoor air samples to evaluate the subsurface vapor migration to indoor air pathway, it is important to consider the contribution of background (indoor) sources and ambient (outdoor) sources to indoor air quality. Background or ambient sources may contribute vapors to indoor air at detectable concentrations, or possible concentrations above target levels. The relative contribution of background contaminants is more significant at lower concentrations.

#### 2.1.1 Indoor Air Sources

Potential indoor sources for background contaminants include household activities (smoking, cleaning, hobbies), consumer products (gasoline, heating oil, cleaning supplies, glues), or building materials (carpets, paints, glues). A summary of potential indoor sources for chemicals is provided in Figure 2-1 (Hers et. al., 2001). This table is not intended to be a complete summary of potential sources, but is provided to illustrate potential sources to consider.

Source	Benzene	Toluene	Ethylbenzene	Xylene	Styrene	Trimethylbenzene	Naphthalene	Trichloroethene	Trichloroethanes	Perchloroethene	Chlorobenzene	Decane
Latex Paints	X	X				X						
Alkyl Paints									X	X		
Carpets	X	X			X	X						
Glued Carpets	X	X			X	X					X	X
Wood Burning		X		X	X	X	X					
Foam Board											X	
Paint Removers		X										
Spray Products				X								
Adhesives/Tapes		X			X		X					X
Room Deodorants											X	
Tobacco Smoke	X	X	X	X	X							
Gasoline/driving	X	X		X	X	X						
Solvents		X	X						X			
Dry Cleaning										X		

From Hers et al., 2001. *The use of indoor air measurements to evaluate intrusion of subsurface VOC vapors into buildings*, J. Air & Waste Manage. Assoc. 51:1318-1331.

**Figure 2-1**  
**Compounds Potentially Contributed from Indoor Sources (Hers et al., 2001)**

Specific chemicals found in household products may be determined by reviewing the Material Safety Data Sheets (MSDS) for the products or through the National Institute of Health Database (<http://hpd.nlm.nih.gov/index.htm>).

### 2.1.2 Outdoor Air Sources

Many of the chemicals considered in the vapor intrusion pathway evaluation are also present in outdoor air. Potential sources of outdoor air impacts include automobile emissions, manufacturing sites, and locations with significant chemical use (e.g., dry cleaners). In some cases, these outdoor air concentrations may be greater than the target risk-based indoor air concentrations. Measured ambient air concentrations for several different locations throughout the United States have been reported (CARB, 2004; USEPA, 1998; and Sexton et al., 2004). A summary of approximately 500 ambient air sample concentrations from the 2002 California Air Resources Board (CARB) Air Toxics testing is provided in Figure 2-2. Detailed evaluation of the CARB database highlights the annual trends in ambient air concentrations (increasing, stable, or decreasing) and the spatial variability in the ambient air background concentrations for many of these chemicals.

## California Air Resources Board 2002 Statewide Annual Toxics Summary

<http://www.arb.ca.gov/aqd/toxics/statesubstance.html>

Chemical	Minimum	Median	Maximum
Acetaldehyde	0.05	1	4.9
Benzene	0.08	0.48	7.3
1,3-Butadiene	0.02	0.1	2.8
Carbon Disulfide	0.05	0.8	5.8
Carbon Tetrachloride	0.01	0.09	0.11
Chloroform	0.01	0.03	0.16
Ethylbenzene	0.1	0.1	2.3
MTBE	0.15	1	13
Methylene Chloride	0.05	0.2	6.7
Styrene	0.05	0.05	1.2
Tetrachloroethene	0.005	0.05	0.92
Toluene	0.2	1.3	22
1,1,1-Trichloroethane	0.03	0.04	0.3
Trichloroethene	0.01	0.01	0.23

**Figure 2-2**  
**Examples of Concentrations of VOCs Measured in Outdoor Air (in ppbv)**

Outdoor air quality may contribute VOCs or SVOCs to indoor air at concentrations above target levels; therefore it is advisable to include collection and analysis of outdoor air samples in the scope of work conducted for any indoor air quality survey. It may also be informative to collect



outdoor air samples when conducting a soil gas survey in urban areas, because ambient air can lead to detectable concentrations of VOCs in soil gas when detection limits are as low as those required to meet soil gas target screening levels.

### 2.1.3 Indoor Air Background Concentrations

Estimates for background concentration for chemicals in indoor air have been reported in several studies (Shah and Singh, 1998; USEPA, 1998; Kurtz and Folkes, 2002; and Sexton et al., 2004). A summary of the background concentrations reported in these studies is provided in Figure 2-3. Due to the changes in indoor air sources and outdoor air concentrations over time, when available, background concentrations from more recent studies are likely to be more representative. Note that the indoor air background concentrations are typically greater than the values reported for ambient air. This is due to the contribution of indoor air sources in addition to outdoor air concentrations on the indoor air quality.

Chemical	Kurtz & Folkes, 2002.			CDOT MTL 2002	EPA Inside IAQ, 1998	Shah and Singh, 1988	Sexton et al., 2004		
	Median	95% UCL	Max	Mean (range)	“Typical Value”	Mean	Median	10 %ile	90 %ile
Benzene	-	-	-	3.5 - 4.4	5	16.5	1.9	0.8	15.3
Carbon Tetrachloride	-	-	-	-	-	-	0.5	0.4	0.9
Chloroform	-	-	-	1.9 - 4.4	1	4.1	0.9	0.1	3.4
1,1 Dichloroethane	<0.08	<0.08	0.16	<0.08	-	-			
1,2 Dichloroethane	0.04	0.07	0.72	0.069 – 0.085	-	-			
1,1, Dichloroethene	<0.04	<0.04	<0.04	0.01	-	-			
Ethylbenzene	-	-	-	-	5	12.5			
Methylene Chloride	0.88	4.5	180	1.1 – 2.2	10	-	1.1	0.2	11.5
Tertachloroethene	1	2.2	440	1.4 – 8.8	5	21	0.6	0.2	3.8
Toluene	-	-	-	-	20	28			
1,1,1- Trichloroethane	0.86	2.5	210	0.70 – 1.67	-	270			
Trichloroethene	0.13	0.22	27	0.13 – 0.58	5	7.2	0.2	0.0	0.8
Vinyl Chloride	0.01	0.02	0.5	0.011 – 0.017	-	-			
Xylenes	-	-	-	-	15	50			

**Figure 2-3**  
**Background Ranges from Various Published Studies ( $\mu\text{g}/\text{m}^3$ )**

Note that for benzene, the target indoor air concentration corresponding to an incremental lifetime cancer risk of  $10^{-6}$  is  $0.31 \mu\text{g}/\text{m}^3$ ; therefore, background air quality may often represent a risk greater than  $10^{-6}$ , and in some cases, may represent a risk greater than  $10^{-5}$ . The same is true for other compounds, depending on the source of background data and the target incremental cancer risk, which may vary from site to site. Therefore, subsurface vapor intrusion assessments need to correct for background contributions to improve the accuracy of vapor intrusion determinations and prevent unnecessary installation of mitigation systems.

### **2.1.4 Options for Assessing Indoor Air Background Concentrations**

Many of the reported background indoor air concentrations were determined by collecting indoor air measurements in homes/buildings that are not influenced by subsurface impacts. While this may seem to be a simple approach, without adequate subsurface characterization it may be difficult to assure that there are no subsurface impacts beneath the homes/buildings sampled. Also, occupant's habits and commercial products vary considerably from house-to-house, so control properties may not provide relevant background data. Therefore, it is generally not recommended to include indoor air quality monitoring in homes outside of the study area in order to assess background concentrations. Alternate approaches have been used to assess indoor air background concentrations. These alternate approaches include:

- Qualitative comparison to published data for background (indoor) and ambient (outdoor) air quality.
- Use of a tracer compound to select homes with no (or insignificant) subsurface impacts.
- Evaluation of indoor air concentrations prior to and after operation of vapor intrusion mitigation systems.
- Evaluation of the ratio of indoor air to subsurface concentrations for a large data set including a wide range of subsurface concentrations.

Available studies of background or ambient air quality could potentially be used for qualitative comparisons of measured indoor air concentrations (see reference list), and if the concentrations are similar, this may indicate that subsurface vapor intrusion is negligible. However, this is a qualitative approach because background and ambient air quality is variable in space and time and the amount of data required for a robust statistical comparison is often lacking, or truncated by non-detect values.

For many chlorinated solvent sites, the compound 1,1-dichloroethene (11DCE) may be present, and if concentrations are detectable in the subsurface and indoor air samples, it may be used as a tracer compound to help assess vapor intrusion impacts for other VOCs. Many indoor air background studies have concluded that the typical background indoor air concentration for 11DCE is below the normal TO-15 detection limit (0.5 ppbv). If 11DCE is present in the subsurface and detected in indoor air, it may be used to calculate a site-specific empirical attenuation factor. This attenuation factor can then be multiplied by the subsurface concentrations of other VOCs to calculate the indoor concentration that would be attributable to subsurface vapor intrusion, providing the relative concentrations and distributions of 11DCE and the other VOCs are similar in the subsurface. If 11DCE is not detectable in indoor air, this approach may still be useful as an upper bound estimate of the contribution of other VOCs from subsurface vapor intrusion. Additional discussion of 11DCE is provided by Kurtz and Folkes (2002).

Folkes (2000) reported measured indoor air concentrations for several chlorinated hydrocarbons before and after the operation of a subsurface depressurization system to mitigate subsurface vapor intrusion (see Figure 2-4).

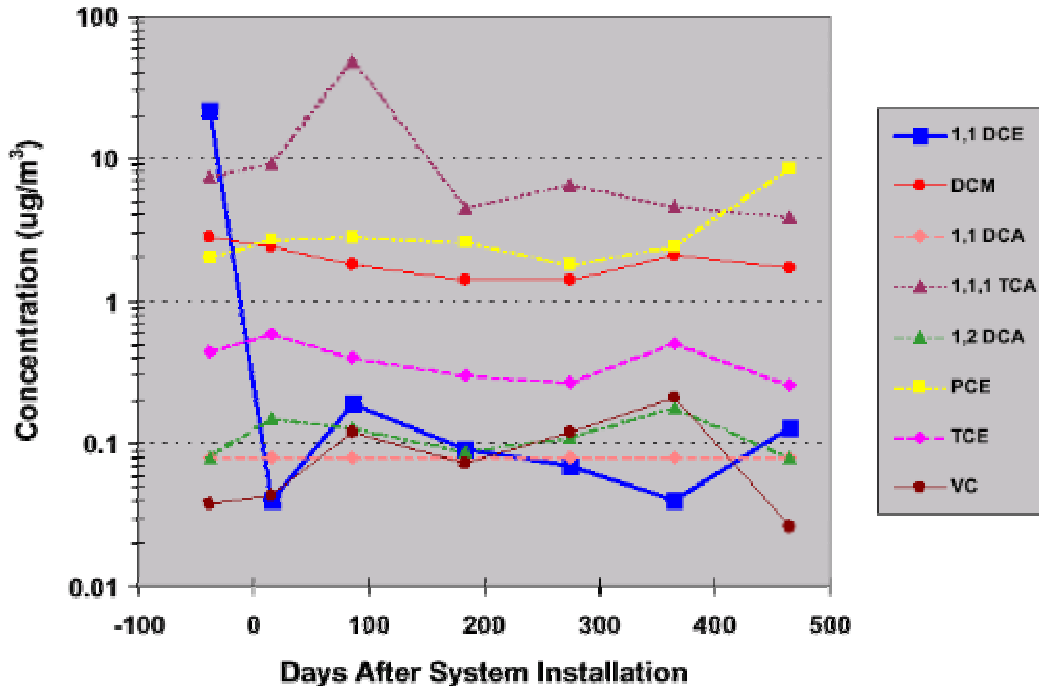

**Figure 2-4**  
Concentrations of VOCs before and after Sub-slab Venting (Folkes, 2000)

These results show about 99% decrease in 11DCE concentrations following the operation of this system. The fact that concentrations of the other constituents did not show a reduction indicates that these post-mitigation concentrations are due to outdoor air or indoor sources and represent background concentrations. This strategy could be used in short-term (“pilot-test”) mode as a site assessment tool to effectively demonstrate whether VOCs in indoor air are attributable to subsurface vapor intrusion, or background.

## 2.2 Conceptual Models

A conceptual model provides a framework for interpreting the processes influencing the fate and transport of chemicals as they move from a source to a receptor. A conceptual model is not the same as a mathematical model, but should be the basis for one. A conceptual model combines available site-specific information with theoretical considerations and experience from similar sites to form an expectation of site conditions. As site-specific data are collected, they are compared with the conceptual model, and revisions are made, as needed. Conceptual models are often described using a source-pathway-receptor framework, which has been adopted herein. Thus, the conceptual model evolves over time as information is collected, becoming more comprehensive, and sometimes more complex in the process.

The most common conceptual model for subsurface vapor intrusion considers a source of chemicals at some depth below a building, upward diffusion of vapors at steady-state, convection into the building from the close proximity of the floor slab, and dilution within the building ventilation. This simplified scenario is shown schematically in Figure 2-5, from the user manual for the US EPA spreadsheet implementation of the Johnson and Ettinger (1991) model.

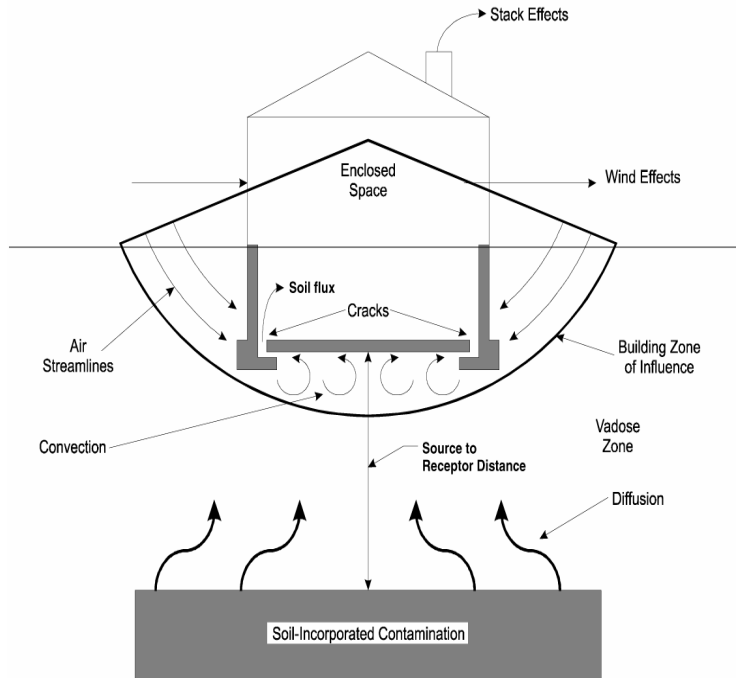

**Figure 2-5**  
**Simple Conceptual Model of Vapor Intrusion (EQM, 2000)**

The upward diffusion arrows above the source and the circular convection arrows beneath the floor slab should be straight to conform with the 1-D model formulation. Also, the building zone of influence and air streamlines are schematic at best. Several other mechanisms may be important, depending on site-specific conditions, as discussed further below.

### 2.2.1 Source

In general, vapors may originate from NAPL-impacted soils, groundwater containing dissolved contaminants, or from the decomposition of contaminants or buried wastes. In some cases (e.g. dry-cleaners), indoor air within buildings may be a source of vapors to the subsurface. It is critical to understand the nature of the source in order to design an appropriate source characterization program.

The location of the vapor source relative to the water table or capillary fringe can be important when assessing vapor intrusion at a particular site. In general, a source can exist above the saturated zone (e.g., soils with residual NAPL), just above the water table (e.g., light, non-aqueous phase liquid (LNAPL) floating on the water table or disseminated within the capillary fringe) or in the saturated zone (e.g., soluble groundwater plume). The potential migration of vapors toward an overlying building will vary significantly between these conditions, primarily because effective diffusion coefficients in the unsaturated zone for most compounds are about 4 orders of magnitude (10,000 times) higher than effective diffusion coefficients in the saturated and tension-saturated zones.

The approximate mass of the source should be considered, to assess whether it is large enough to be a persistent source for 30 years or not. A very small release can result in localized soil vapor concentrations higher than the target levels, but may not be sufficient to sustain an unacceptable flux to indoor air over a 30-year exposure scenario. Estimating the mass of a source is challenging, and the uncertainty in the estimate should be considered as part of the conceptual model.

The source constituents should be evaluated and identified to the extent practical, which may be challenging for some mixtures. A solvent release may be predominantly a single compound, although intrinsic biodegradation may generate daughter products that may be more or less mobile and/or toxic. Confirmation of a limited number of compounds in a source may provide the basis to reasonably limit the scope of an indoor air assessment to only these compounds. By contrast, a hydrocarbon release typically contains a mixture of hundreds of compounds, of which very few may be the only significant contributors to health risk, and some of which may be non-toxic and readily degradable under aerobic conditions. Waste disposal or recycling facilities may have even more complex mixtures. For NAPL mixtures, volatilization of individual constituents is dependent on the composition of the mixture and the fraction of each constituent may change significantly as weathering proceeds. Typically lighter compounds are more volatile and will decrease in concentration with time, leaving a mixture with increasing relative proportions of heavier, less volatile compounds. The volatility, toxicity, mobility, degradability and initial mass fraction may all need to be considered for multiple compounds to identify primary chemicals of concern and develop a practical list of target analytes.

Some sources produce vapors only by volatilization from aqueous or non-aqueous releases, but others actively produce gases such as methane, carbon dioxide or other volatile metabolites as products of biodegradation. Gas produced as a byproduct of microbiological activity can generate pressure gradients that enhance subsurface vapor migration by advection, in addition to diffusion. Pressure in soil gas monitoring probes can easily be measured using manometers, as described further in Appendices F and G.

### **2.2.2 Pathway**

The movement of chemicals from the source to the building is described in the pathway component of the conceptual model. The pathway might include for example soil gas transport from a source above the water table to an overlying building (as shown in Figure 2-6). It might happen by a combination of groundwater transport from a primary source to an adjacent property, with subsequent off-gassing and vapor transport through the unsaturated zone to an overlying building. It may include lateral diffusion through the unsaturated zone without contact or interaction with groundwater, as shown in Figure 2-6.

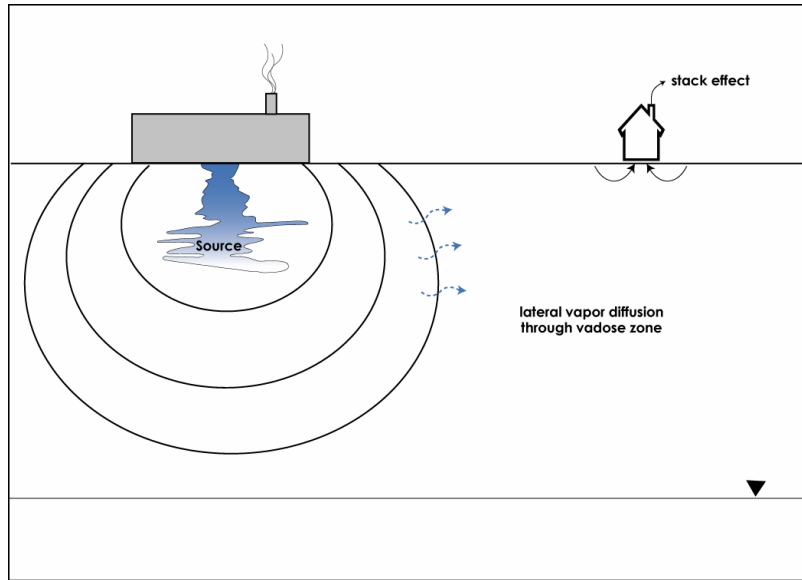

**Figure 2-6**  
**Lateral Diffusion of Vapors Through the Unsaturated Zone (schematic)**

There may also be preferential soil gas flow through granular fill under a building (Figure 2-7), especially in areas where the gas permeability of the surrounding soil is very low. Floor drains, for example, are designed to allow water to drain away, but are not designed to eliminate soil gas entry. The granular materials surrounding a sewer pipe may or may not be compacted after placement, so settlement over time may form air voids beneath the slab that are very highly permeable. Foundation walls are usually constructed first, then floor slabs are poured, often leaving a space between the floor slab and walls (i.e., perimeter crack) for expansion and contraction. This perimeter crack is often obscured by wall-coverings, and may not be accessible for inspection or direct testing. The same may be true for other utility penetrations and homeowner modifications, which may also create a pneumatic connection to granular fill.

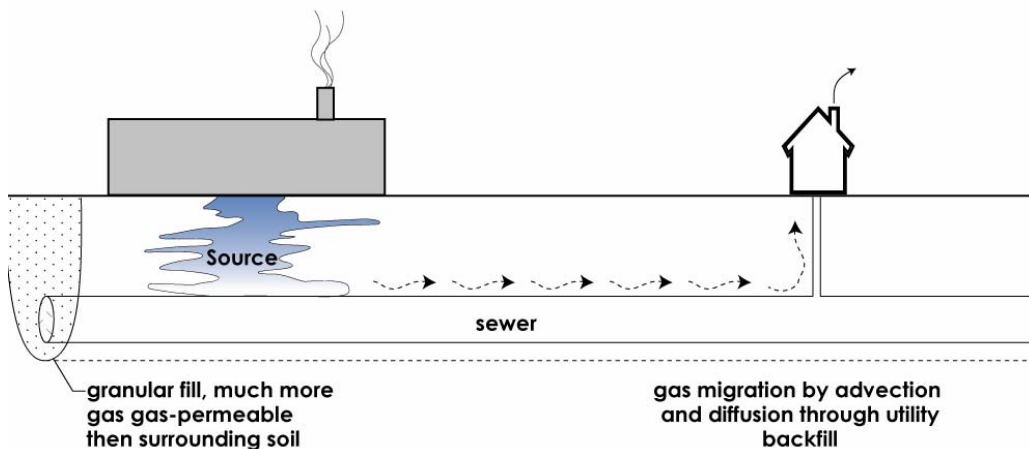

**Figure 2-7**  
**Vapor Transport Through Preferential Pathways (schematic)**

Sumps or wet basements can also allow groundwater containing VOCs to enter the building, or contact the building envelope directly (Figure 2-8). This scenario can be especially problematic if the source of vapors is in the form of LNAPL floating on the water table. The wet basement scenario can be challenging to assess because it may be impossible to collect sub-slab soil gas samples or exterior soil gas samples from adjacent to the building and below the footing, which are two of the common lines of evidence for vapor intrusion assessments. It may therefore be necessary to rely on shallow groundwater and indoor air data for the assessment. The relative concentrations of various chemicals in each media should be similar if the origin of the vapors in indoor air is the subsurface. Compounds with higher proportions in indoor air relative to other compounds are likely to either originate from indoor or outdoor air sources, or at least have a contribution from background sources that should be closely reviewed.

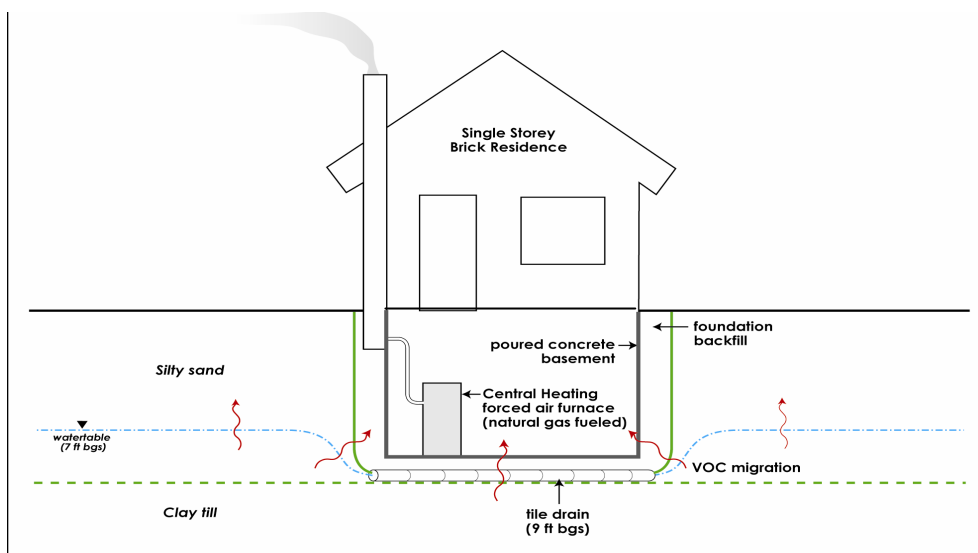
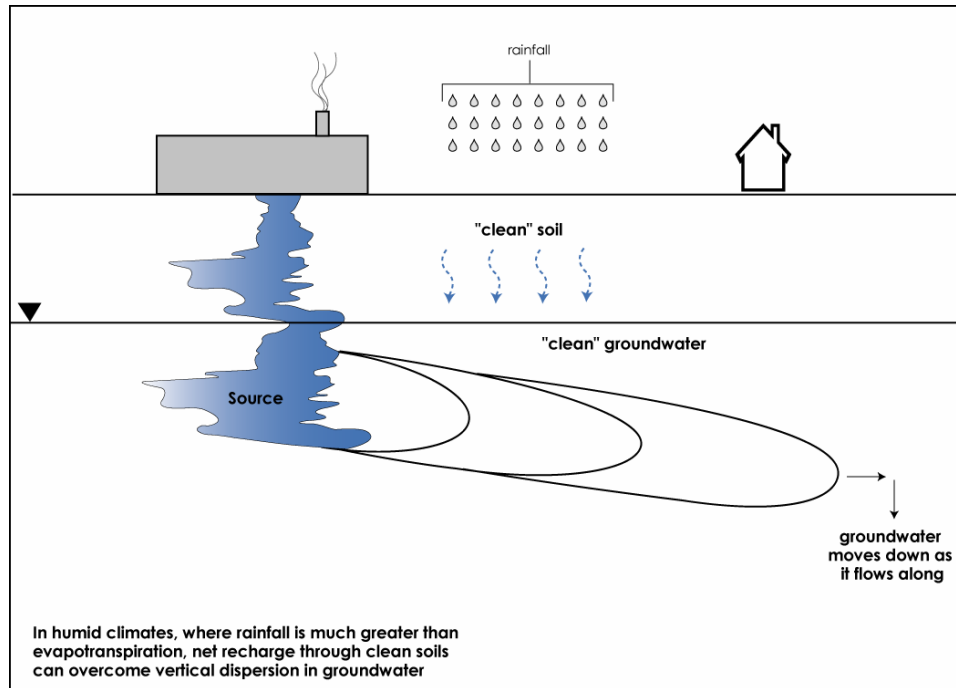

**Figure 2-8**  
**Vapor Intrusion in a Building with a Wet Basement (schematic)**

Conceptualization of the pathway should also include potential vapor migration barriers. A low-permeability layer in the unsaturated zone with high moisture content or perched water may impede or prevent upward migration of vapors from deeper sources. If the recharge rate is sufficient to cause perched water layers within the unsaturated zone, there may be an effective vapor barrier. The seasonality of infiltration would need to be considered in this scenario. Areas that receive regular rainfall will be more likely to sustain layers of high moisture content in the unsaturated zone than areas with wet and dry seasons. Also, there may be a “rain-shadow” beneath a building where moisture contents are lower.

In humid climatic regions and areas with artificial recharge (e.g. irrigation, storm-water retention ponds) a layer of clean water may accumulate above a plume of VOCs in groundwater, the thickness of which would typically grow with increasing travel distance and time from the point of release. This condition has been referred to as a “fresh-water lens” (Fitzgerald and Fitzpatrick, 1996, McAlary et. al., 2004), and can act as an effective vapor barrier, inhibiting off-gassing of VOCs from the water table sufficiently to protect overlying buildings from subsurface

vapor intrusion, as shown in Figure 2-9. This condition may not develop if water table fluctuations are large, which would result in vertical mixing of VOCs across the upper saturated zone. In some cases, such barriers can impose sufficient resistance to vapor transport to make the vapor intrusion pathway insignificant. Characterization of the barrier may require investigative methods such as pneumatic or geophysical testing, which are different from the techniques commonly used to assess the vapor intrusion pathway (e.g., soil gas and indoor air sampling).



**Figure 2-9**  
**Fresh Water Lens as a Barrier to Volatilization from Groundwater (schematic)**

The building heating, ventilating and air-conditioning (HVAC) system and various other mechanical devices also affect the pathway, shown on the detailed generic conceptual model in Figure 2-10. Where buildings are heated, convection cells develop with hot air rising and leaking through roofs and upper-floor windows. This phenomenon is referred to as the “stack effect”, and is commonly assumed to cause de-pressurization in the bottom floor of a building by a few pascals. The escaping air will be replaced to some degree by soil gas entry at lower levels/basements.



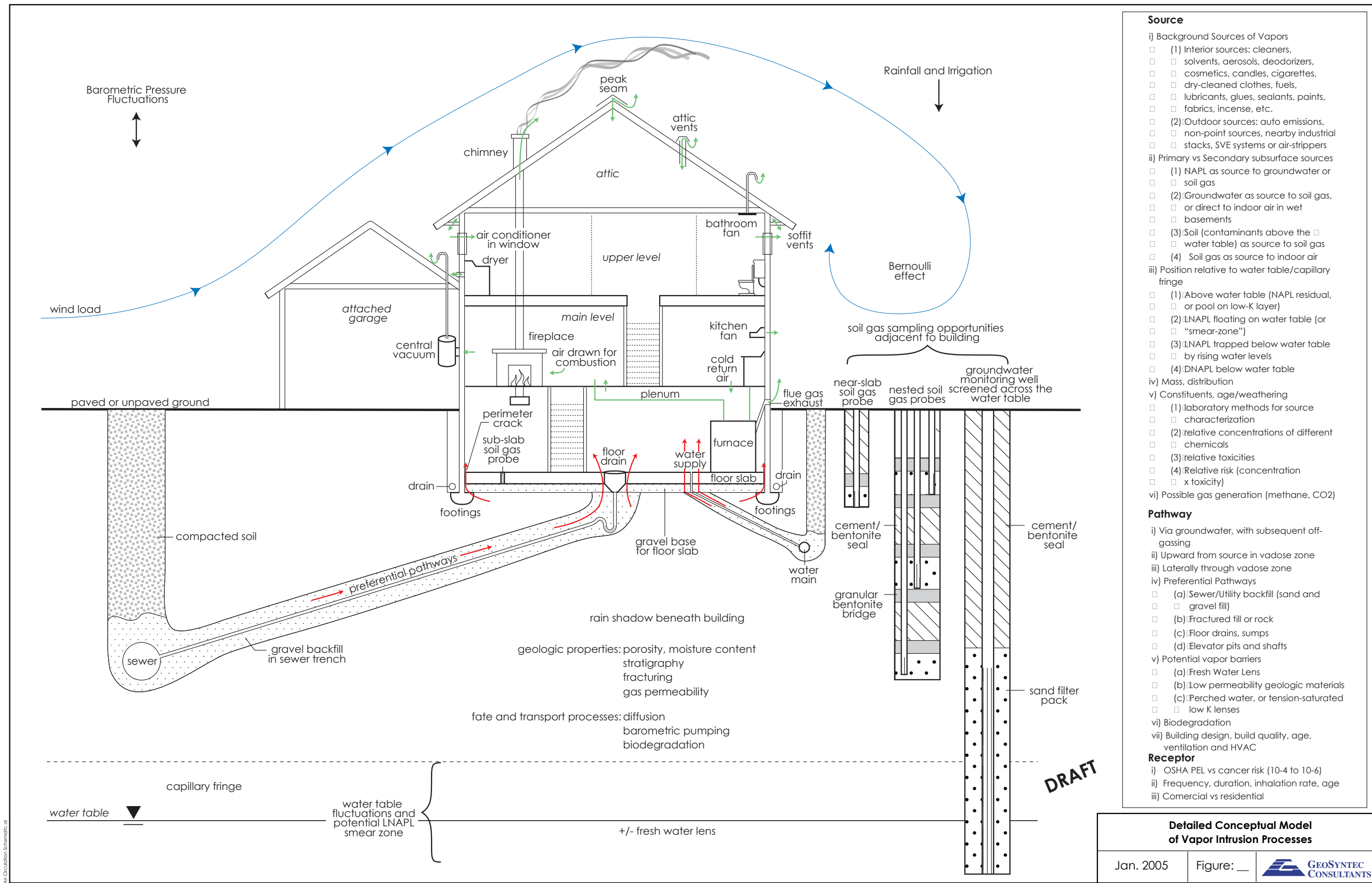

Figure 2-10 Detailed Conceptual Model of Vapor Intrusion Properties



Even where buildings are not mechanically heated, solar radiation on rooftops can heat air in the attic significantly and cause the same effect. Bathroom exhaust fans, central vacuum cleaners, clothes dryers and kitchen exhaust fans all remove air from a building. Elevator shafts can also cause localized pressure gradients. Window-mounted air conditioners blow air into a building. In commercial/industrial buildings, HVAC units are usually mounted on the roof, and blow air into the building, heating or cooling it as appropriate for the season or climate. These units may also be designed to exhaust a portion of the indoor air to provide a certain amount of outdoor air into the building as fresh air or “makeup air”. Often the ventilation requirements of commercial or industrial buildings are dictated by local building codes. Operation of HVAC units can generate sufficient pressure or vacuum to significantly influence vapor intrusion, and may be worth considering as part of the Conceptual Model. Verification of these pressure gradients typically requires a digital micro-manometer, which are in common use in the HVAC industry. In many cases, valuable information (air exchange rate, building pressure, seasonal changes, etc.) can be obtained from the HVAC engineer, with minimal effort. The “stack-effect” is a function of the height of a building and the temperature difference between inside and outside, and can result in underpressurization of hundreds of pascals in very tall buildings.

### **2.2.3 Receptor**

For vapor intrusion studies, the receptor is usually the occupant(s) of a building. Receptors are generally either residents or workers, with exposure frequency and duration, and possibly inhalation rate being the primary differences in the exposure scenarios. The default values vary somewhat between regulatory agencies, so the practitioner should take care to be consistent with policies of the jurisdiction in which the assessment is conducted.

Worker exposures may be compared to risk-based targets or to indoor air quality standards specified by the Occupational Safety and Health Administration (OSHA), or the National Institute for Occupational Safety and Health (NIOSH), such as Permissible Exposure Levels (PELs). PELs are generally orders of magnitude higher than indoor air target levels based on a 10E-4 to 10E-6 incremental lifetime cancer risk or a hazard index of 1. The applicable indoor air target concentration should be defined as early as possible in the vapor intrusion pathway assessment process.

The level of risk is proportional to the concentration in the breathing zone. Vapor intrusion rarely results in indoor air concentrations high enough to pose an acute risk; however, explosions have occurred as a result of landfill gas intrusion, so the possibility of high concentrations is an important consideration. Several published standards are available for comparison, including:

LEL – lower explosive limit

NIOSH IDLH – National Institute for Occupational Safety and Health Immediately Dangerous to Life and Health (NIOSH, 1995)

ACGIH STEL – American Council of Government Industrial Hygienists Short-Term Exposure Limit

OSHA PEL – Occupational Safety and Health Administration Permissible Exposure Limit

ASTDR Acute MRL – Agency for Toxic Substances and Disease Control Minimum Risk Level for acute exposures (1-14 days) (ASTDR, 2004)

ASTDR Intermediate MRL – MRL for exposures >14-364 days,

ASTDR Chronic MRL – MRL for exposures 365 days and longer,

Target Concentrations for non-carcinogens – typically a Hazard Index =1.0

Target Concentrations for carcinogens – 10E-4 to 10E-6 incremental lifetime cancer risk

The concentrations corresponding to each of these benchmarks span a very wide range, as shown in the table below (expressed in units of parts per billion by volume, or ppbv). It should be noted that the target concentrations for incremental lifetime cancer and non-cancer risks usually have several conservative assumptions (dose-response relationship is linear, with no threshold dose), and compounding factors of safety (interspecies, sensitive receptor, etc.), and may therefore be overly protective by up to several orders of magnitude.

	OSHA PEL	ASTDR Acute	ASTDR Intermediate	OSWER 10E-5
Exposure	8 hr TWA	1 day	2 weeks	30 year
Benzene	10,000 ppbv	50 ppbv	4 ppbv	0.98 ppbv
TCE	100,000 ppbv	2,000 ppbv	100 ppbv	0.041 ppbv*

\*- assumes draft cancer slope factor of August 2001, which is under review

## 2.3 Fate and Transport Mechanisms

Knowledge of the theory of vapor fate and transport mechanisms is essential for interpreting the data collected during a site-specific assessment of subsurface vapor intrusion. It is also invaluable for selecting data collection activities to focus on the most important locations, compounds, or parameters in order to maximize the data value. Theoretical considerations should be the backbone of the Conceptual Model and mathematical model. Data will help to identify “what” is happening, but theory is required to understand “why”.

### 2.3.1 Vapor Diffusion in Soils

Molecular diffusion results in movement of chemicals away from areas of higher concentrations toward areas of lower concentration. The mass flux,  $J$  [ $M/L^2-T$ ], is calculated by Fick’s law and is equal to the concentrations gradient,  $\partial C/\partial z$  [ $M/L^4$ ], multiplied by the effective diffusion coefficient for the medium,  $D_{eff}$  [ $L^2/T$ ]:

$$J = -D_{eff} \frac{\partial C}{\partial z}$$

Where  $C$  is the vapor concentration (mass/volume of gas) and  $z$  is the distance over which the concentration change is measured. The subsurface is porous, some of which some is air-filled

and some is water-filled. The overall effective vapor-phase diffusion coefficient for a compound through a porous medium can be estimated as a combination of diffusion through the soil vapor ( $D_{air}$  multiplied by the tortuosity of the gas phase) and diffusion through the soil moisture ( $D_w$  multiplied by the tortuosity of the water phase).

$$D_{eff} = D_a \frac{\theta_a^{10/3}}{\theta_T^2} + \frac{D_w}{H} \frac{\theta_w^{10/3}}{\theta_T^2}$$

Where  $D_a$  is the free-air diffusion coefficient [ $L^2/T$ ],  $D_w$  is the aqueous diffusion coefficient [ $L^2/T$ ],  $\theta_a$  is the soil air filled porosity [volume vapor/total volume],  $\theta_T$  is the soil total porosity [volume pores/ total volume],  $\theta_w$  is the soil water-filled porosity [volume water/total volume], and  $H$  is the dimensionless Henry's Law Constant [molar concentration in gas / molar concentration in water]. The tortuosity of each phase is assumed to follow the empirical equation derived by Millington and Quirk (1961). Free air diffusion coefficients are typically about 10,000 times higher than aqueous diffusion coefficients, so the second term will generally be negligible, except under nearly saturated conditions (such as within the capillary fringe) or for compounds with very low Henry's Law Constants (<0.001).

### 2.3.2 Phase Partitioning

Phase partitioning calculations can be performed to estimate the concentration in any one of the phases (gas, liquid or solid) from the concentration in another phase (i.e. a soil gas sample), or the sum of all phases (i.e. a bulk soil sample), providing the total porosity, moisture content and fraction of organic carbon (Foc) of the soil are known. These soil properties and bulk soil VOC concentrations can be highly variable on small scales (i.e., the scale of typical soil sample volumes), so partitioning calculations generally reflect this variability. Therefore, it is generally best not to try to calculate soil gas concentrations from bulk soil concentrations, but rather to measure soil gas concentrations directly. The draft OSWER guidance doesn't consider screening the pathway using soil VOC concentrations for this very reason.

LNAPL and DNAPL sources in the unsaturated zone will generally vaporize at an appreciable rate, unless the mass is very large (e.g. forming pools with a very low surface area to volume ratio), or the soil moisture is very high (reducing the rate at which vapors can migrate away from the source), or the soil gas in the vicinity surrounding the NAPL becomes saturated. The maximum soil vapor concentration [vol/vol] that can be achieved in immediate proximity to a NAPL can be calculated as the ratio of the vapor pressure to the total pressure, which is essentially atmospheric pressure. This can be thought of as a saturation limit in air. If the NAPL consists of a mixture of compounds, Raoult's Law can be used to calculate the maximum soil vapor concentration, which requires measurement or estimation of the mole fractions of the constituents of the mixture. Depending on the complexity of the mixture, variations from this ideal behavior may be significant.

Measured groundwater and soil gas concentrations do not always show the ratio predicted by Henry's Law, primarily because the scale of measurement is such that the samples of deep soil gas and shallow groundwater may be separated by a distance that is not negligible, and there are factors such as borehole dilution that may induce sampling bias. Furthermore, the partitioning in

mixtures is a complex phenomenon, especially for high molecular weight compounds. Therefore, it is usually advisable to collect deep soil gas data to provide quantitative evidence of the degree of off-gassing from the water table where groundwater concentrations appear to be high enough to cause a potential vapor intrusion concern. Chemical transport from groundwater to the unsaturated zone can occur by diffusion through the capillary fringe (i.e., tension-saturated zone), but the diffusion coefficient through the saturated capillary fringe will be low. The capillary fringe thickness depends on the texture of the geologic materials, ranging from a few centimeters in sands and gravels (which may impose negligible resistance to off-gassing) to many meters for clays. Mass transfer to the unsaturated zone will increase if the water table fluctuates, occasionally resulting in lower water saturation and better connection with the overlying unsaturated zone. A falling water table has the same effect, leaving impacted water above the water table in tension that was previously below the water table and thereby facilitating off-gassing as shown on Figure 2-11. A high rate of rainfall recharge may create a blanket of clean water at the water table, providing that the infiltration does not occur through a NAPL-impacted vadose zone or one containing VOC vapors. This layer may act as an effective barrier to off-gassing from the water table, causing a fresh-water lens, as shown in Figure 2-9. Many sites with subsurface contamination have groundwater monitoring wells with many years of data that can quickly be reviewed to assess the potential for each of these conditions.

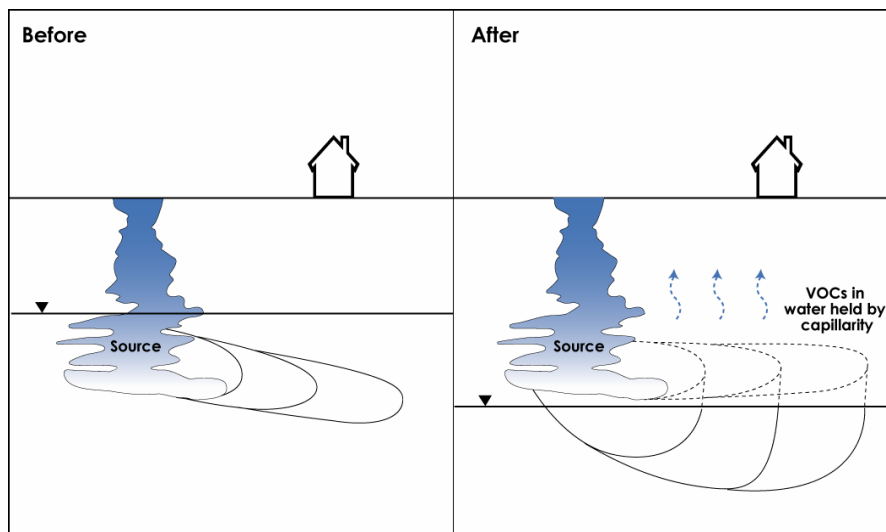

**Figure 2-11**  
**Effect of Falling Water Table on Off-Gassing from Groundwater (schematic)**

### 2.3.3 Soil Gas Advection

Advection of soil gas into buildings occurs due to under-pressurization of the building relative to pressure in shallow soil gas. The building under-pressurization can be a result of the “stack effect” (warm air rising inside the building, exiting through roof vents, and creating suction in lower levels), barometric pumping, exhaust fans, clothes dryers, central vacuums, or elevators (acting as a piston). The soil gas flow rate into a building ( $Q_{soil}$ ) is a function of building pressure, permeability of soils immediately beneath the foundation, and characteristics of vapor entry points through the foundation. While models have been proposed to estimate the soil gas

volumetric flow rate, it is best to use typical  $Q_{soil}$  values unless site-specific measurements are available, due to the uncertainty in many of the model input parameters.

Wind load on a building can also influence indoor-to-subsurface pressure differentials. In some cases, wind being forced to rise over a building can create lift in the same manner as the wing of an airplane, and generate significant suction of air into the building.

Barometric pressure changes are often hundreds of pascals (Pa) over a few hours, or as much as 2,500 Pa over as little as a day. Anecdotal information from the radon field confirms that barometric pressure fluctuations can cause variability in indoor air concentrations of more than an order of magnitude in response to barometric pressure changes. Therefore, it is advisable to measure barometric pressure or sub-slab-to-indoor air pressure differentials when conducting indoor air or sub-slab soil gas sampling. Barometric pressure data is usually available from a local weather station, and barometric pressure measurement devices with data loggers are inexpensive and readily available. Pressure differentials require a micro-manometer for accuracy.

### **2.3.4 Building Characteristics**

Soil vapor intrusion to indoor air can occur regardless of whether a building has a basement, slab-on-grade or crawlspace design. It can also occur even when the building has a concrete floor that appears to be free of cracks. Vapor barriers are placed under some buildings to attempt to inhibit subsurface vapor intrusion, but the barriers are typically plastic sheets that can reduce advection of soil gas, but may not significantly impede diffusion. If not properly designed and installed, vapor barriers may contain inadvertent perforations, and air flow may be significant even through a small perforation. Intrinsically safe buildings may be limited to those constructed on stilts (such as may occur in lowland areas subject to regular flooding). Buildings can have several intake or exhaust fans, as shown on Figure 2-10. Air exchange rates are typically lower for houses with energy efficient designs, as low as about 0.1 or 0.2 air exchanges per hour (AEH) (ASHRE, 1995).

Once subsurface vapors migrate to the building, the building ventilation will result in a mixing of the chemical through the interior. From a modeling perspective, it is commonly assumed that the chemical distribution in the lowest floor of the building is uniform and that the concentration is controlled by the building ventilation rate (or air exchange rate). Concentrations will be higher in rooms with limited ventilation (e.g. cellars) or immediately adjacent to points of entry (sumps, floor cracks, etc.) to the point where concentrations may be detectable with field instruments.

### **2.3.5 Effects of Biodegradation**

Several vapor intrusion studies (Hers et al, 2000; Lahvis et al., 1999; Roggemans, 1998; Roggemans et al., 2001; Fischer et al, 1996; Fitzpatrick and Fitzgerald, 1996, Ostendorf and Kambell, 1991; DeVauil et al, 2002) have demonstrated that the aerobic biodegradation of hydrocarbon vapors can be significant in the vadose zone. These studies reached these conclusions through: (1) field investigations examining soil gas concentration profiles of petroleum hydrocarbons and indicators of biological activity (oxygen and carbon dioxide), (2) a

comparison of modeled and measured vapor intrusion attenuation factors for petroleum and non-petroleum compounds, and (3) modeling studies to characterize the potential impact of biodegradation on the indoor air concentrations.

DeVaull et al. (1997) listed conditional criteria for aerobic biodegradation of aromatic hydrocarbons in soil. In order for biodegradation to occur, sufficient hydrocarbon, oxygen, nutrients, moisture, and microbial populations must be present. Typically, sufficient oxygen is the limiting criteria since sufficient microbes, soil moisture, and nutrients are present at most sites. Biodegradation of contaminant vapors can occur by anerobic processes where oxygen has been consumed or by cometabolic processes where there are appropriate mixtures of primary metabolites and cometabolites, but both of these processes tend to be less significant than aerobic metabolism.

The rate and extent of aerobic degradation varies from site to site (Roggemans et al, 2001), such that it is difficult to predict the degree of degradation a-priori, or even model it without collecting some site-specific information regarding the vertical profile of O<sub>2</sub>, CO<sub>2</sub> and VOCs. Methods have been developed to model vadose zone biodegradation beneath open surfaces (Lahvis and Baehr, 1997 and 1998) and beneath buildings (Johnson et al., 1999; Johnson and Abreu, 2003, Abreu and Johnson, 2005a,b). First order and Monod degradation kinetics have been included in these models. Some of the more refined methods model the coupled transport and reaction of hydrocarbons and oxygen. Depletion of oxygen in the subsurface may result from consumption resulting from the biodegradation process. As an example, the model of Abreu and Johnson (2005) was used to assess a variety of scenarios (Abreu and Johnson, in submission). The model domain and general conditions are shown on Figure 2-12.

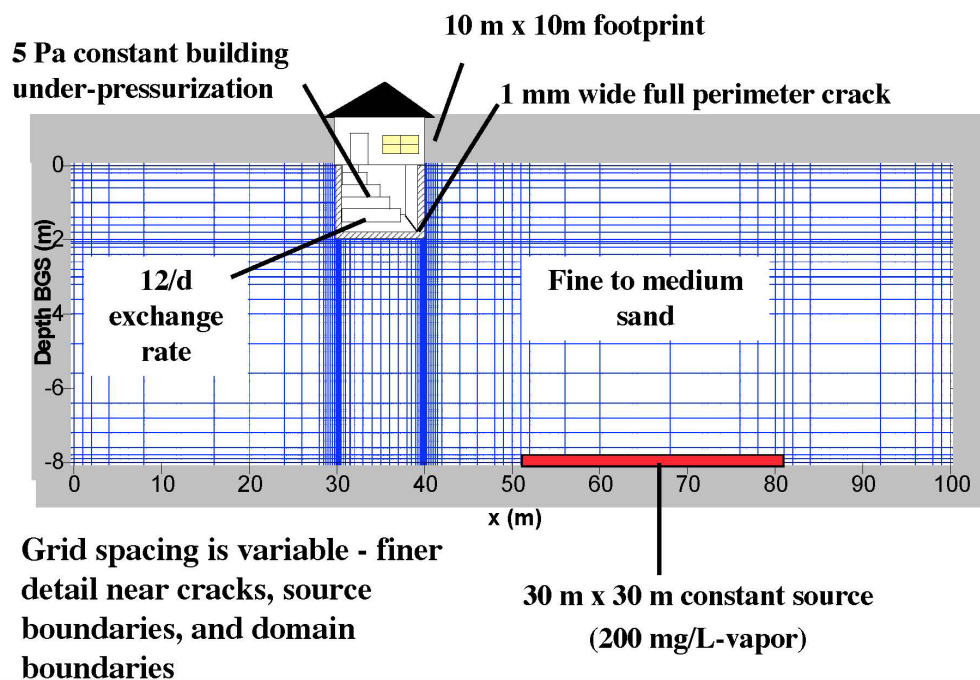

**Figure 2-12**  
**Model Domain and General Conditions for 3-D Vapor Intrusion Model (Johnson and Abreu, 2003)**



Figures 2-13, 2-14 and 2-15 show the modeled distribution of O<sub>2</sub> and a hydrocarbon as a function of the thickness of the vadose zone beneath the building. These plots show normalized (i.e. C/C<sub>max</sub>) concentrations of O<sub>2</sub> (blue contours) and a typical hydrocarbon (orange contours). Also listed with each plot are the calculated attenuation factors with and without biodegradation. Where the vadose zone has limited thickness, biodegradation may have a negligible influence, but where sufficient thickness is available, biodegradation alone may be sufficient to prevent unacceptable vapor intrusion. Where oxygen concentrations are very low, the aerobic degradation rates will diminish. If oxygen is sufficiently consumed, methane production may occur.

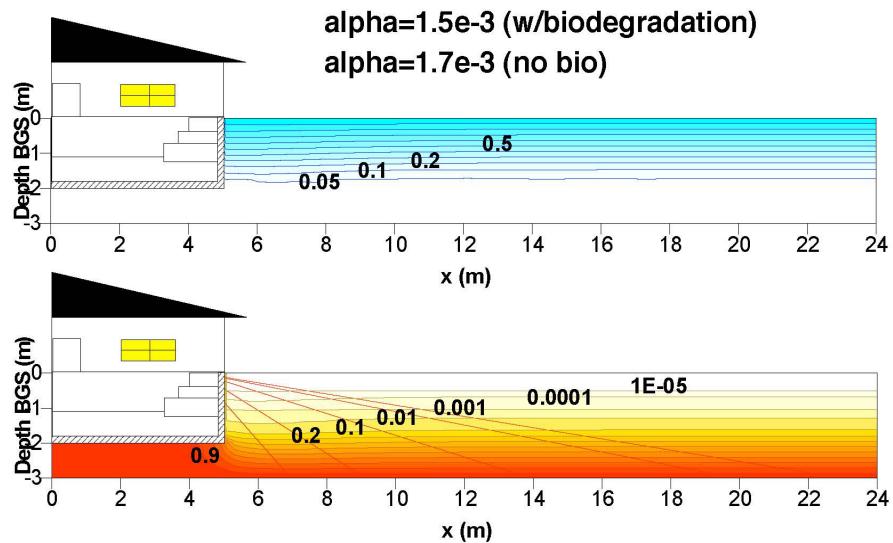

**Figure 2-13**  
 Modeled subsurface O<sub>2</sub> and VOC distribution with biodegradation – shallow source  
 (Johnson and Abreu, 2003)

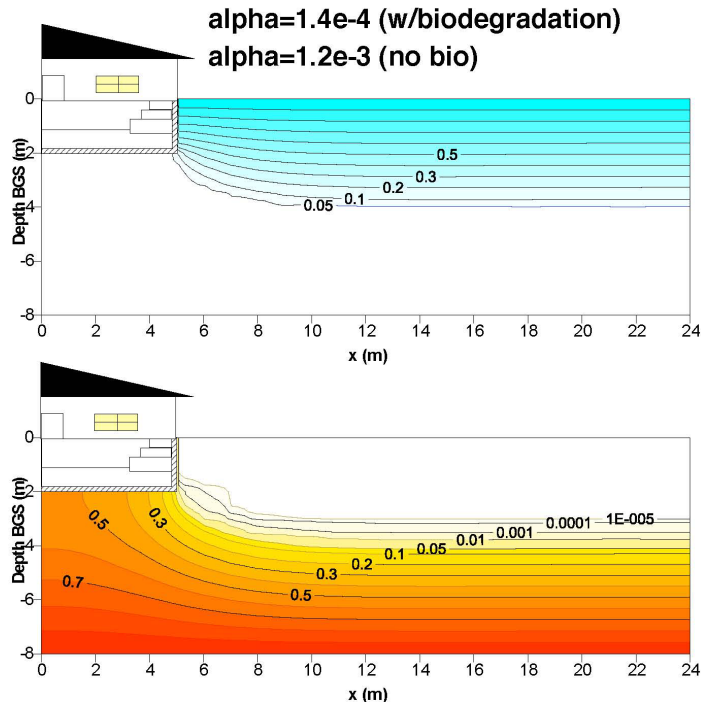

Figure 2-14  
Modeled subsurface O<sub>2</sub> and VOC distribution with biodegradation – intermediate depth source (Johnson and Abreu, 2003)

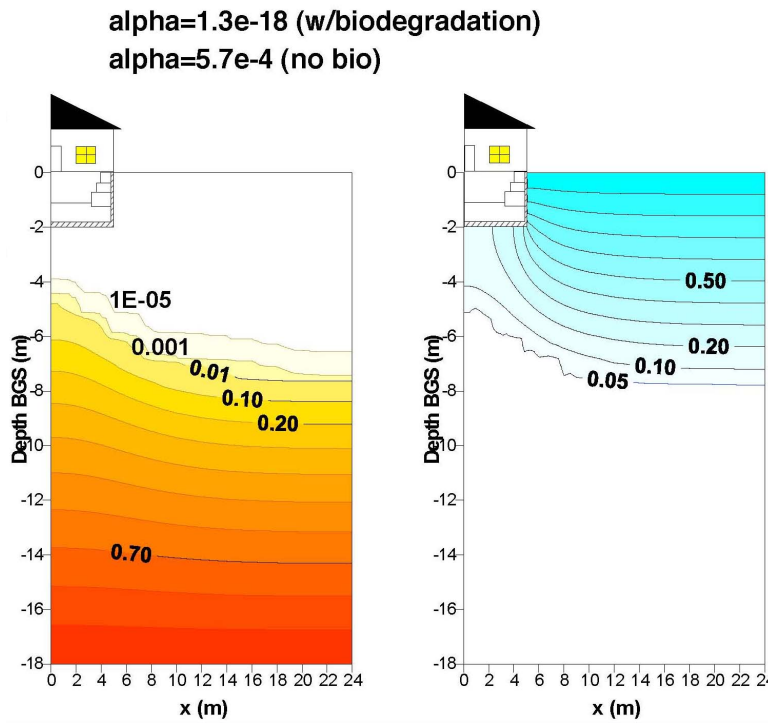

Figure 2-15  
Modeled subsurface O<sub>2</sub> and VOC distribution with biodegradation – deep source (Johnson and Abreu, 2003)

## 2.4 Considerations Specific to Different Families of Chemicals

The processes affecting the fate and transport of subsurface vapors and their entry into building are relatively similar for compounds with similar properties, so it is useful to consider a few different families of chemicals as opposed to hundreds or thousands of individual compounds. The subsections below describe common characteristics for each of several families.

### 2.4.1 Petroleum Fuels: Gasoline, Diesel, Heating Oil, Jet Fuel, etc.

Petroleum fuels are refined from crude oil through fractional distillation. Most of these products are mixtures of hundreds of compounds, primarily aliphatic and aromatic hydrocarbons, typically with little or no halogenated compounds. Benzene, toluene, ethylbenzene and xylenes are often the primary compounds of concern from a regulatory perspective (referred to collectively as BTEX), although they typically make up only a small fraction of the total vapors. Background concentrations of several constituents of these mixtures are often detectable in indoor and outdoor air because of the common usage of fuels in modern society.

In most cases, many constituents of these mixtures are readily degradable by ubiquitous soil microorganisms in the presence of oxygen. In some cases, the oxygen consumption will be create locally anaerobic zones, in which case, anaerobic degradation may also occur. The lighter fractions typically degrade faster and are more volatile than the heavier fractions, so the content of the lighter compounds decreases as weathering occurs.

Fuels are typically less dense than water and have moderate to low viscosity, so they can be distributed as a layer of product floating on the water table over a relatively large area. A floating NAPL layer can get smeared by water table fluctuations, resulting in some trapped NAPL droplets below the water table. NAPL trapped below the water table (water-solid-NAPL system) will pose a much less significant risk of vapor intrusion, because NAPL below the water table must first dissolve into groundwater, then migrate upwards to the water table before volatilizing from the groundwater to soil gas.

Fuels may pose a potential explosion hazard in some circumstances. Reports of gasoline odors in buildings should be assessed immediately with an explosimeter. Microbiological degradation can also produce methane, which is explosive in the range of 5 to 15% by volume. Under methanogenic conditions, hydrogen sulfide (H<sub>2</sub>S) is also often produced, so explosimeter testing should also be considered when there are reports of rotten egg odors (although this may be attributable to sewer gas, and not vapor intrusion).

Many NAPL mixtures (e.g. mineral spirits, lubricating oils) are typically less volatile than petroleum fuels and not often considered for the vapor intrusion pathway. Considering that NAPL mixtures may have constituents that are variable from site to site, it may be appropriate to confirm the absence of potential vapor intrusion concerns by analysis of the headspace above a sample of NAPL, if available. Vaporization varies with temperature, so any such test should be performed at a temperature similar to the average subsurface temperature from the study site, which is not necessarily similar to the average temperature in an analytical laboratory. The concentrations of individual compound vapors in the headspace could then be multiplied by an

appropriate attenuation factor for comparison to indoor air quality targets. If the results indicate no potentially unacceptable risks, no further assessment would be necessary.

Several EPA TO-Methods can be used for analysis of various hydrocarbons. The most appropriate method should be selected through discussion with the analytical laboratory after identifying the most likely chemicals of concern and their target levels in soil gas or indoor air. Research methods such as proton-transfer-reaction mass spectrometry (PTR-MS) may also prove valuable in some circumstances.

#### **2.4.2 Chlorinated Solvents**

Chlorinated ethenes, chlorinated ethanes, and chlorinated methanes have been commonly used as solvents for several decades, although they are becoming less common in consumer products over time. Degradation in the subsurface is predominantly by reductive dehalogenation, an anaerobic process that tends to be limited in the unsaturated zone, due to the presence of oxygen, although there is evidence of aerobic degradation of vinyl chloride, and cometabolism of some chlorinated solvents in the presence of methane, propane or other cometabolites. Chlorinated solvents generally have relatively low solubility, high vapor pressure, and are therefore relatively mobile and persistent in the unsaturated zone.

EPA Method TO-15 includes the common chlorinated solvents on the target analyte list. The standard analysis will provide reporting limits of 0.5 ppbv, which is adequate for soil gas sampling, but selected ion monitoring (SIM) may be required to provide reporting limits low enough to reach indoor air target levels, depending on the chemicals of concern at a particular site. The SIM analysis should not be performed on soil gas samples, as discussed further in Chapter 3.

#### **2.4.3 Manufactured Gas Plant (MGP) Wastes and Coal Tar**

Manufactured gas plants (MGP) were used between the 1800s and mid-1900s to convert coal and oil into gas for heating, lighting, and cooking before the development of natural gas systems. The contaminants of concern (COC) at MGP site can be categorized into five chemical types: inorganics (e.g., cyanides), metals, volatile aromatics, phenolics, and PAHs. PAH-containing soils represent the largest waste type at most MGP sites (Srivastava, 1997). The COCs in coal tar are predominantly BTEX and PAHs, plus some cresols and phenolics. Of these, BTEX are the most volatile and most often considered in the vapor intrusion pathway. Although PAHs are considered “semi-volatile” for analytical purposes some, particularly naphthalene, are sufficiently volatile to also be of potential concern for vapor intrusion. As of August 2004, naphthalene is being considered by California DTSC to be potentially carcinogenic. BTEX and PAHs are also common constituents of substances like petroleum fuels, tobacco and fireplace smoke, and asphalt. Therefore, at MGP sites, it may be desirable to evaluate the presence of trace indicator compounds that may be associated with coal tars (e.g., indane, indene, thiophenes, although they may also be derived from other sources) but not petroleum fuels (e.g., MTBE), or vice versa, to aid in identifying the source of any commonly occurring hydrocarbons that might be detected. The relative concentrations of various constituents in hydrocarbon mixtures may be variable from site-to-site, so it may be necessary to perform site-specific analyses of source

materials to identify compounds that may be useful as indicators. Comprehensive reports of hydrocarbon constituents were prepared by The Total Petroleum Hydrocarbon Criteria Working Group Series (1998), and API (1994, Appendix C). These lists may help identify potential indicator compounds (see Figure 2-16). Ratios of individual compounds, or groups (e.g. aromatic/aliphatic compounds) may also be potentially used to identify the source of hydrocarbons—EPRI and others plan to work in this area so as to provide a database of information for use by practitioners. Use of carbon isotope ratios by GC-IRMS is another developing technique which may merit consideration in some situations, but further research is needed in this area.

## Use of Indicator Compounds

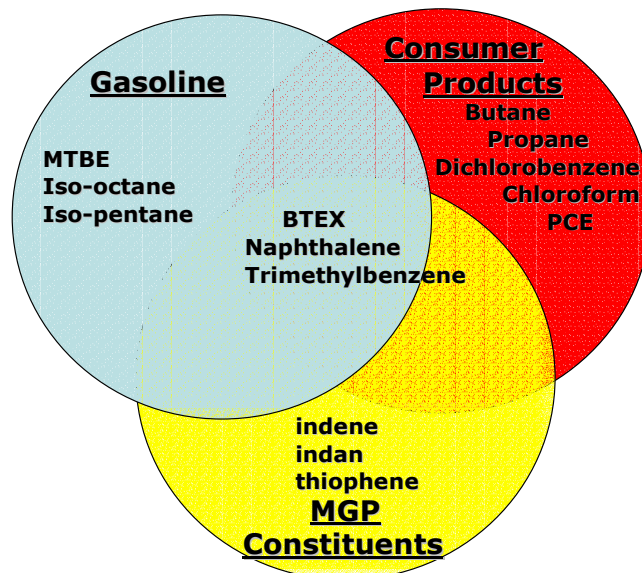

**Figure 2-16**  
Compounds that may be useful for distinguishing between various hydrocarbon mixtures (Berry-Spark, et. al., 2004).

MGP constituents include both volatile organic compounds, and less volatile or semi-volatile organic compounds (SVOCs). SVOCs are similar to VOCs, except that their maximum vapor concentrations are lower and their organic carbon partitioning coefficient ( $K_{oc}$ ) values tend to be higher, indicating a potential for reduced mobility of vapors through sorption to subsurface solids. In practice, retardation via adsorption becomes negligible once all the available sorptive sites are occupied, so the mobility of SVOC vapors may not be significantly retarded, especially at sites where releases occurred decades ago.

For a comprehensive characterization of MGP sites, it may be necessary to collect samples for VOC analysis (EPA Method TO-15 or similar, collected in a Summa™ canister), and SVOC or

PAH analyses (EPA Method TO-17 or TO-13A, collected using an ATD tube). There is no standard EPA method for analysis of MGP wastes, and there is no standard list of constituents. Therefore, it may be desirable at more complex sites to consider including Tentatively Identified Compounds (TICs) in the analyses of at least selective samples representative of subsurface source areas in order to identify all potential COCs and potential indicator compounds or tracers.

#### **2.4.4 Other High Molecular Weight Organic Compounds**

Table 1-1 of the draft OSWER Guidance includes a number of compounds considered by the EPA to be sufficiently volatile and toxic to pose a potential risk via subsurface vapor intrusion to indoor air, including pesticides, PCBs, and other high molecular weight organic compounds. To the extent that such compounds are known or suspected to be present at a given site, it may be necessary to include them in the site characterization program. This poses a potential challenge for selection of appropriate sampling and analytical methods. Some compounds may be possible to analyze by multiple methods, and some compounds have target concentrations lower than currently available methods of analysis, so it is not possible to provide a complete and unique guide to the selection of sampling and analytical methods for all compounds. To the extent that high molecular weight compounds are present at concentrations above screening levels, it may be necessary to develop a sampling and analytical program that is unique for a particular site.

#### **2.4.5 Metals/Inorganics**

Most metals are not sufficiently volatile to present a risk via vapor intrusion and inhalation. However, there are exceptions in some circumstances. Elemental mercury is volatile and the vapors are potentially toxic, although reported cases of mercury in indoor air are typically associated with interior sources. Hydrogen cyanide has a very high vapor pressure (83 kPa at 20C) and a low target indoor air concentration (0.03  $\mu\text{g}/\text{m}^3$  for residential scenario and 10E-6 incremental cancer risk, draft OSWER Guidance, Table 2c). These compounds are not included in the list of analytes for EPA Methods TO-15 and TO-17, and may require specialized sampling equipment and methods. Further research would help to assess whether and to what extent metals and inorganic vapors contribute to subsurface vapor intrusion.

#### **2.4.6 Methane**

Methane is produced in landfills and by degradation of hydrocarbons under anaerobic conditions. It is explosive in the presence of oxygen ( $\text{O}_2$ ) at concentrations in the range of about 5 to 15%. Methane can be assessed using portable instrument (explosimeter). Landfill gas meters will provide  $\text{O}_2$  and  $\text{CO}_2$  measurements in addition to reading of total combustible gases (usually predominantly methane) expressed as a percentage of the Lower Explosive Limit (LEL). Since  $\text{O}_2$  and  $\text{CO}_2$  data can be very useful for assessing biodegradation and atmospheric air entrainment in samples, there are many circumstances where a landfill gas meter is valuable in field sampling programs. Explosive hazards can be managed through immediate evacuation and ventilation.

# 3

## SAMPLING AND ANALYSIS CONSIDERATIONS

---

The sampling and analysis necessary for site-specific assessment of subsurface vapor intrusion is challenging because of the low target concentrations, multiple alternative sources of vapors at these low concentration levels, and the potential for compromised samples. This chapter will discuss these challenges in detail, and discuss approaches for managing them.

### 3.1 Context of Sampling and Analysis Challenges

Indoor air sampling and analysis may initially seem like the first choice for assessing subsurface vapor intrusion to indoor air; however, the results are almost always difficult to interpret because of background contributions from consumer products, building materials, and even outdoor air sources. Several compounds have indoor air quality target concentrations that are lower than typical reporting limits for conventional laboratory methods of analysis. For example, the standard reporting limit for EPA Method TO-14 and TO-15 is 0.5 ppbv, but the target indoor air concentration for 10E-6 lifetime incremental cancer risk is 0.098 ppbv for benzene or 0.0041 ppbv for trichloroethene (TCE). Analytical laboratory capabilities have improved to provide lower reporting limits (for example EPA Method TO-15 with selective ion monitoring), but in some cases, the target concentrations are still difficult or impractical to achieve, in which case, indoor air quality monitoring may not be a viable line of evidence and other lines of evidence will be required. Indoor air quality can also be variable, depending on wind, barometric pressure, occupant's activities and heating or air conditioning operations. Therefore, indoor air quality measurement is generally not simple or unambiguous.

Soil gas sampling avoids some of these issues. Soil gas concentrations will generally have to be considerably higher than target indoor air concentrations before a risk is posed via vapor intrusion because of the attenuation from subsurface to indoor air. Therefore, it is generally easier to resolve soil gas concentrations against background and analytical detection limits. Soil gas surveys have been commonly used for fast and inexpensive site-wide screening to identify possible areas of VOC releases for decades; however, the necessary detection levels for that purpose are typically orders of magnitude higher than those needed for vapor intrusion assessments. Typical detection limits for handheld photoionization detectors (PIDs) or flame ionization detectors (FIDs) are in the range of 1,000 ppbv (roughly 5,000  $\mu\text{g}/\text{m}^3$  for a typical chlorinated solvent). Mobile laboratories have traditionally provided detection limits in the range of 100 – 1,000  $\mu\text{g}/\text{m}^3$  (roughly 20 to 200 ppbv). The target indoor air concentration for benzene at the 10E-6 incremental cancer risk level in a residential exposure scenario is 0.3  $\mu\text{g}/\text{m}^3$  (0.098 ppbv). With a default attenuation factor of 0.01, the soil gas target screening level for benzene would be in the range of 30  $\mu\text{g}/\text{m}^3$  (9.8 ppbv), which is lower than the detection limits for common soil gas survey techniques. Published guidance for soil gas sampling and analysis to address vapor intrusion data quality objectives is sparse at this time. The ASTM Standard Guide

for Soil Gas Monitoring in the Vadose Zone (D-5314-92) was originally written in 1991, and re-authorized in 2001, since which time there has been a rapid increase in interest in vapor intrusion. The California Department of Toxic Substances and Los Angeles Regional Water Quality Control Board have issued a soil gas sampling advisory (DTSC & LARWQCB, 2003) that provides guidance on soil gas sample collection. API has recently published a document on the use of soil gas data for assessing vapor intrusion that is the most comprehensive treatise on the subject to date (API, 2004). However, several guidance documents for vapor intrusion assessment provide no substantial discussion of soil gas sampling methods (OSWER, 2002, MADEP, 2002 etc.).

Groundwater sampling and analysis methods are generally more mature than soil gas sampling methods, however, groundwater is furthest removed from the receptor, and the estimation of indoor air concentrations from groundwater data is therefore least likely to correlate strongly with indoor air concentrations.

It is important to design the site-specific assessment with consideration of the challenges facing each of the sampling and analytical approaches. In many cases, multiple lines of evidence may be advisable to avoid potential biases inherent in any single method. This Chapter describes the theoretical considerations, which will help the practitioner in study design. Suggested methods based on these considerations are presented in Section 7, but the theory in this Chapter will help if any modifications to the suggested methods are required to accommodate site-specific conditions.

### **3.2 Pros and Cons of Sampling for Various Media**

Samples for chemical analysis may be collected from several different media during the course of a vapor intrusion pathway evaluation, including indoor air, soil gas (sub-slab or in native material), and groundwater. Samples from these different media have their own particular uses, benefits, and cautions as summarized in Table 3-1, below. More detailed descriptions of the benefits and limitations of the various sample collection options are included in this section.



**Table 3-1  
Benefits and Limitations of Samples from Various Media**

Media	General Description/ Comment	Benefits	Limitations
Groundwater	Groundwater monitoring wells are installed outside the building footprint. Screened interval must cross the water table, and preferably be short.	<p>Is not intrusive into residence. Simpler access agreements</p> <p>Sampling protocols are more mature than soil gas equivalents</p>	<p>May not be representative of conditions immediately beneath building</p> <p>Existing wells may not have shallow and short screens</p> <p>Requires extrapolation or modeling to estimate indoor air concentrations</p>
Sub-slab soil gas	Probes are drilled through building foundation to collect soil gas sample.	<p>More representative of composition of subsurface vapors that may migrate to indoor air.</p> <p>Impacts of background sources of chemicals are less significant</p>	<p>Intrusive. Requires access to living area, and may cause minor damage to flooring</p> <p>Multiple samples (in time and position) are necessary to estimate representative concentrations beneath entire floor slab</p> <p>Requires extrapolation or modeling to estimate indoor air concentrations</p>
Soil gas	Probes are installed outside of building footprint. Typical depths range from 5 to 30 feet (but can be deeper).	<p>Is not intrusive into residence. Simpler access agreements</p> <p>Impacts of background sources of chemicals are not significant</p> <p>Soil gas program may be used to quantify the significance of biodegradation.</p>	<p>May not be representative of conditions immediately beneath building because of rainshadow beneath building, and possible impedance to O<sub>2</sub> recharge under floor slab.</p> <p>Requires extrapolation or modeling to estimate indoor air concentrations</p>
Indoor air	Typically, 8 or 24 hour sample collected from basement or living area of building	Evaluates the concentration of chemicals of concern at the point of exposure.	<p>Intrusive. Requires access to living area</p> <p>Difficult to distinguish background impacts on analytical results. The measured concentration may not be due to vapor intrusion pathway.</p> <p>Multiple samples (in time and position) are necessary to estimate representative concentration for a 30 year exposure scenario</p>

### **3.2.1 Shallow Groundwater**

Groundwater quality data in general is the farthest removed of all media from the receptor, and for this reason, should generally be considered a supporting line of evidence. Nevertheless, groundwater sampling data are likely to be available at many sites, even where soil gas data have not yet been collected, so it is often the first available line of evidence for screening the vapor intrusion pathway. Furthermore, groundwater sampling protocols have been developed and refined over the course of the past few decades to the point where many historic causes of bias and variability have been resolved, so the data quality tends to be good. Even where groundwater data are not already existing, groundwater samples can often be collected as quickly and as easily as soil gas samples. Groundwater fate and transport processes have been extensively studied and may be more predictable than soil gas fate and transport processes, so it may be easier to delineate a plume of VOCs in groundwater than soil gas. The groundwater sampling approach is attractive where potentially large areas may have been impacted. Conversely, if a building is overlying soils contaminated with residuals from historic releases, groundwater quality data may not be relevant at all. For a building with a basement depth similar to the depth to the water table (“wet basements”), groundwater may be the only media beneath the building that can practically be sampled.

As groundwater containing dissolved volatile chemicals flows away from a release area, infiltrating rainfall can develop a fresh water lens on top of the dissolved contaminants, which may significantly reduce volatilization from groundwater to soil gas. A fresh water lens of a foot or a few feet in thickness may be sufficient to minimize or eliminate volatilization from the groundwater, but most conventional groundwater monitoring wells have screened intervals of 5 to 10 feet in length and would typically collect a water sample that is an integrated mixture of the groundwater along that interval. If there is an LNAPL on the water table, deeper groundwater may have lower concentrations and the mixed sample would underestimate the concentration at the water table and capillary fringe. Conversely, if there is a fresh-water lens, the mixed sample from a 10-foot screen may obscure this fact. These possibilities are shown on Figure 3-1, which shows three scenarios that may all result in groundwater samples with the same concentration, but would result in significantly different deep soil gas concentrations (Johnson, 2002).

# Issues -

## Proper Sampling and Interpretation of Ground Water

Concentration is Critical [i.e., each average concentration does not correspond to a unique vapor transport scenario]

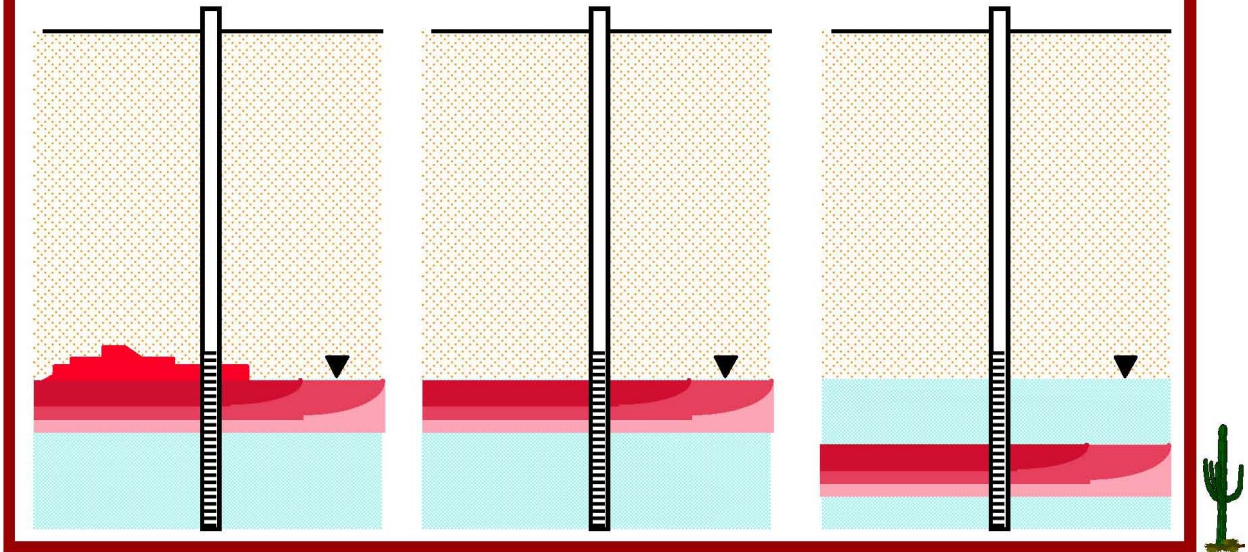

Paul C. Johnson - Arizona State University 2002

**Figure 3-1**  
Effect of Well Screen Position and Borehole Dilution (Johnson, 2002)

A similar scenario is possible if there is a net rise or fall of the water table elevation because of a regional drought, over-pumping, improved recharge or other effects. The concentration may appear to increase or decrease even if there is no real change in the contaminant distribution, simply because of a change in the degree of borehole dilution.

At sites where groundwater concentrations appear to be high enough to contribute to vapor intrusion, it may be appropriate to collect confirmatory soil gas data to assess the degree of volatilization from the water table. Transects of shallow groundwater samples can be helpful in some cases for determining an appropriate scope of soil gas and indoor air quality monitoring programs. To the extent practicable, groundwater samples should be collected over a narrow interval (a few feet or less) just below the water table. At some sites, assessment of the vertical profile of concentrations may help demonstrate the presence of the fresh water lens.

### 3.2.2 Sub-Slab Soil Gas

Sub-slab soil gas is the gas that exists immediately beneath the floor of the occupied structure, regardless of whether the structure is a slab-on-grade or basement design. Sub-slab soil gas

sampling is relatively simple and can be accomplished with an electric hammer-drill, avoiding the need for a more-costly drilling rig. The relative proportion of vapors from indoor sources will generally be much lower in sub-slab samples than indoor air samples, although with barometric pressure fluctuations, it is possible for indoor air sources to cause vapors to move from the building into the sub-slab soil gas. Concentrations of vapors in sub-slab samples would presumably be higher than indoor air concentrations and therefore, may also be better resolved against analytical reporting limits. Sub-slab soil gas sampling methods may not be practical for buildings with suspended floors and crawlspaces.

Sub-slab sampling has certain drawbacks. It requires an access agreement from the building owner, and is intrusive to the extent that equipment must be brought into the building, dust is generated and floor-coverings may be damaged. Relatively little information is available to demonstrate how sub-slab soil gas concentrations vary over time, or in response to barometric pressure changes. The draft OSWER guidance recommends three sub-slab samples for a building the size of a typical domestic residence, so sub-slab sampling efforts are not insignificant, especially if the vapor intrusion assessment includes a neighborhood of residences. In many cases, the locations of sub-slab utilities (sewer, water, gas, electrical, etc.) are not marked and may not be provided on private property by third party utility clearance agencies, creating a risk of damage when drilling through the floor slab. Sub-slab probes have a smaller seal than soil gas probes, so it is important to ensure the seals are placed carefully. The competence of the seals can be readily evaluated through the use of tracers, as described in Section 6.1.8.

### **3.2.3 Soil Gas Samples Collected Adjacent to a Building**

Access constraints are generally reduced if soil gas samples are collected beside a building, and the inconvenience for property owners and risk of property damage are usually diminished. In some cases, the perimeter crack between the bearing walls and the floor slab is the primary point of soil gas entry into a building, and sampling immediately beside the perimeter crack may provide the most representative of soil vapor concentrations entering the building, and therefore be most useful for assessing subsurface vapor intrusion. Johnson and Abreu (2003) showed that the depth of the soil gas sample is very important (Figure 3-2), which shows normalized (i.e.  $C/C_{max}$ ) concentrations of  $O_2$  (blue contours) and a typical hydrocarbon (orange contours). Soil gas probes should be designed so that the tip of the probe extends below the bottom of the bearing wall and any footings, and it may be advantageous to install them to deeper intervals, depending on the depth to the water table, and whether the compounds of concern are aerobically degradable. Shallower probes may be in a location of very steep concentration gradients, and therefore provide inconsistent results.

The depth of soil gas samples collected adjacent to a building is important. If there is advection of soil gas into a building, replenishment via downward flow of atmospheric air beside the building could result in dilution of soil vapor concentrations beside the building, relative to those beneath the building. For aerobically degradable compounds, the oxygen supply in shallow soils beside the building could also be higher, resulting in lower vapor concentrations compared to deeper soil gas. Soil gas beside a building may be different than soil gas under a building for other reasons. The building essentially acts like a large umbrella, preventing infiltration of rainfall, and forming a “rain-shadow” beneath it, where soil would likely have lower moisture

contents than adjacent to the building, where there is often a lawn, which is often irrigated. In some cases, rooftops have no gutters, so rainwater is funneled to the area immediately adjacent to the bearing walls. The differences in vapor concentrations from beside to beneath buildings generally diminish with depth beneath the footings, and may be negligible at depths approaching the water table or impacted soils. Therefore, soil gas samples collected from adjacent to a building should be collected from a depth of at least a few feet below the foundation.

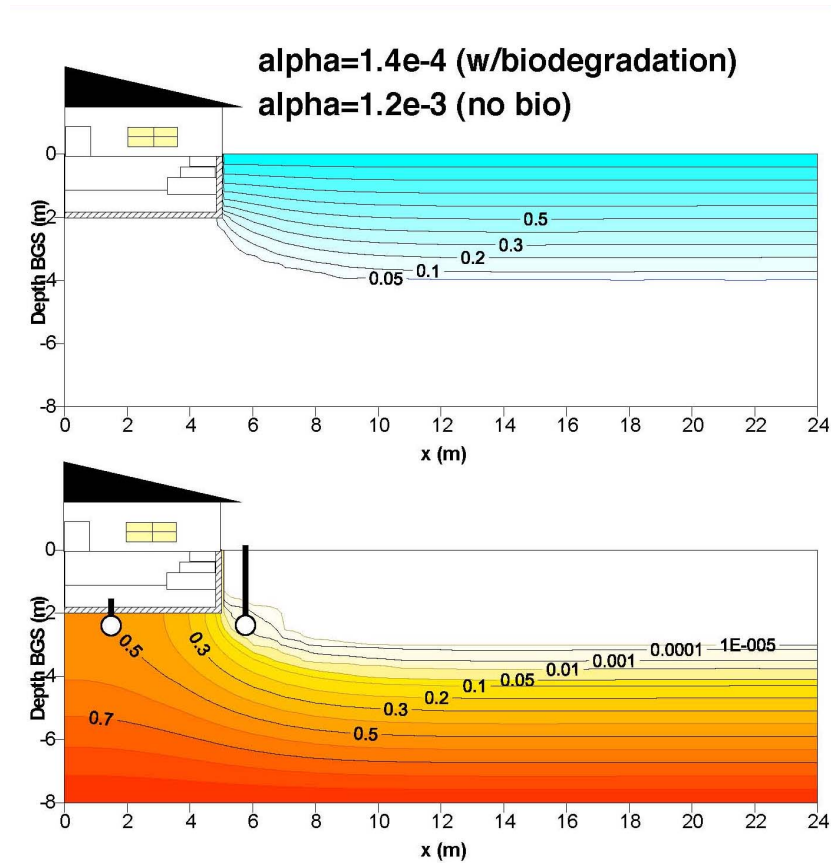

**Figure 3-2**  
**Oxygen and Hydrocarbon Vapor Distribution and Comparison Between Near-Slab and Sub-Slab Sampling (Johnson and Abreu, 2003)**

Spatial variability may also need to be considered and some practitioners have suggested that soil gas samples should be collected from adjacent to all 4 walls of a residence, for example. In general, sample spacing should be proportional to the size of the distribution of chemicals. At some sites, VOCs in groundwater have been mapped over distances of up to several miles, in which case, subsurface concentrations (groundwater or soil gas) are unlikely to vary significantly over distances of 50 feet in the direction of groundwater flow. Concentrations generally change more rapidly in the direction perpendicular to groundwater flow because transverse dispersion is much less significant than longitudinal dispersion. Sample spacing ultimately must be a site-specific consideration. A comprehensive discussion of vertical profiles and transects of soil gas data is provided by API (2004), which may help guide the selection of an appropriate scope of soil gas data collection. In some cases, on-site analysis can help with scoping decisions, providing the required detection limits and data quality objectives can be met.

### **3.2.4 Indoor air**

Indoor air typically contains dozens of chemicals at detectable concentrations, some of which may be the same compounds that are present in the subsurface at a particular site, and some of which may be present in background indoor air or even ambient outdoor air at levels above risk-based target levels. Indoor air sampling will identify detectable compounds from all three sources (subsurface, indoor and outdoor), and the effort required to resolve the relative contribution from each is usually not trivial and may be irresolvable. For this reason, it may be advisable to limit the list of analytes for indoor air samples to those compounds known or suspected to be present in the subsurface at concentrations that pose a potential risk to indoor air quality, where regulatory guidance allows. Access agreements will often be required for indoor air sampling, along with a community relations plan. Therefore, it is usually preferable to assess subsurface concentrations (near-slab or sub-slab) first, and assess potential indoor air concentrations through empirical or modeled attenuation factors. If the subsurface concentrations are too low to pose a potential risk from subsurface vapor intrusion, it may be possible to avoid indoor air sampling and the complexities associated with resolving background contributions.

The decision whether to collect indoor air quality data in the first stage of investigation must be made on a case-by-case basis. Indoor air sampling may be appropriate in a first phase of investigation where access limitations make multiple site visits impractical. It is usually also appropriate to have subsurface and indoor air data that are coincident in time, so if subsurface data alone are collected in the first phase, it may be necessary to repeat subsurface data collection when indoor air data are collected. In the majority of cases, subsurface vapor intrusion does not pose an acute risk; therefore, indoor air sampling should generally be considered after other lines of evidence have been assessed in the site characterization.

### **3.2.5 Soil Sampling**

Soil sampling is generally not recommended for assessing subsurface vapor intrusion to indoor air because there are no published studies that clearly show a unique relationship between measured soil concentrations and measured soil gas concentrations. The poor correlation may be attributable to inconsistent amount of volatilization losses during soil sample collection. The US EPA conducted a study that showed soil sampling and analysis by SW846 Method 8240 may have negative biases of a factor of 10 to 1,000 because of loss of volatiles (EPA/600/SR-93/140). The Encore Sampling device has been developed to manage the volatilization losses, but the field extraction results in a solvent peak during analysis that results in elevated detection limits, which may render the detection limits for this method insufficient for vapor intrusion assessments. Another possible explanation is the fact that the fraction of organic carbon in some soils is highly variable, and the bulk soil concentration can be significantly higher or lower if there is more or less organic matter present, respectively. In most cases, it is easier to obtain a reliable representation of subsurface vapor concentrations by soil gas sampling and analysis, so soil sampling and analysis is generally not recommended. However, there may be cases where the soil gas permeability is too low to enable collection of representative soil gas samples, and soil headspace analysis (as opposed to traditional bulk soil extraction and analysis) might provide a more reliable indication of the potential for vapor intrusion. Research is required to demonstrate whether this is the case (see Section 10.2).

### **3.3 Alternatives to Conventional Sampling and Analysis**

Several alternative investigative techniques have been developed, some or all of which can be used in certain situations as either primary or supporting lines of evidence in assessing subsurface vapor intrusion.

#### **3.3.1 Collection of Soil Gas Samples From Groundwater Wells**

Groundwater monitoring wells are often designed with screened intervals that straddle the water table to allow for sampling of any LNAPL layer, to account for seasonal water table fluctuations, and to establish a water table elevation that is not biased by any vertical hydraulic gradients that may be present. Where the screen extends above the water table into the unsaturated zone, it is possible to draw a vacuum on the well pipe and induce soil gas flow into the well, which can be used to assess soil gas concentrations immediately above the water table. This is particularly useful for assessing whether deep soil gas and shallow groundwater are in equilibrium according to Henry's Law, or whether there is a fresh-water lens or other impediments to off-gassing. It is important to purge several casing volumes of air prior to sampling, because stagnant air in the well casing may be influenced by volatilization from the water column inside the well, which may not be representative of the conditions outside the well. The purge volume can be minimized using a packer near the top of the well screen to isolate the standing air column in the overlying well casing. It is also important to ensure that the vacuum exerted during purging and sampling does not induce upconing of the water table to the extent that the unsaturated screen become saturated, or use a packer to isolate the saturated portion of the well screen.

#### **3.3.2 Passive Soil Gas Sampling**

Adsorptive media can be buried in the ground and retrieved some time later for desorption and subsequent quantification of the adsorbed mass by laboratory analysis. Two commercially available products of this nature are the GoreSorber and EMFLUX cartridges. Advantages of these methods are that they provide a relatively inexpensive and non-labor intensive technique for mapping relative concentrations of subsurface VOCs. The primary disadvantage is that the mass adsorbed cannot be converted as readily into a soil vapor concentration, which is ultimately what is required for risk-assessment purposes. Advances are being developed to address this potential limitation. These methods may be helpful as an initial screening to assess the general distribution of VOCs in soil gas.

#### **3.3.3 Flux Chambers**

Flux chambers are vessels that are inverted over the ground or foundation surface, and vapors diffusing upward into the chamber are sampled for subsequent laboratory analysis, either by passing a sweep gas through the chamber (dynamic testing) or by sampling vapors that accumulate within the flux chamber over a given time period (static testing). Conceptually, the upward flux of VOCs into the chamber can be multiplied by the ratio of the area of a building to the area of the chamber to estimate the upward flux over the scale of a building, which can be converted to an indoor air concentration by dividing by the building ventilation rate. In practice,

this is only possible if the flux chamber mimics at a small scale the processes involved in vapor intrusion at the building scale, and there is significant debate on this topic.

Flux chambers may not be able to represent the flow of soil gas through cracks in a building floor, particularly if the cracks occur around the perimeter walls, or utility entrances, because the chambers may not be able to be positioned around these irregular geometries. Others have expressed concerns that flux chamber data does not compare favorably to other lines of evidence, which may be attributable to the fact that a much higher degree of skill is involved in flux chamber sampling, or that flux chamber samples tend to be collected over relatively short intervals, and transient barometric pressure changes may have a significant influence, possibly resulting in a relatively high risk of a false negative determination (falsely concluding that vapor intrusion is not significant).

Despite their limitations, flux chambers may be an effective tool for evaluating vapor migration to buildings with crawl spaces or bare dirt floors. Flux chambers may also be useful for assessment of undeveloped land slated for re-development where there currently are no buildings for direct measurement of vapor intrusion, but only for compounds that are not aerobically degradable, since a future building would be expected to impeded oxygen supply to the subsurface to some degree. In light of these limitations, flux chambers should generally be used with verification by an independent line of evidence, and should generally be considered a supporting line of evidence.

### **3.3.4 Building Pressure/Ventilation Testing**

The permeability of the building envelope is often tested in research for energy efficiency. A fan is installed in the doorway, and used to blow air into or out of the house. The flow is quantified by measuring the air velocity with a hot-wire anemometer, and multiplying by the area of the fan. Differential pressure from indoor to outdoor (or subsurface) is monitored using vacuum gauges or micromanometers at a variety of different flow rates. This can be performed with the floor seal end unsealed, if furniture is removed, in order to quantify the subsurface contribution to indoor air as a function of building depressurization, although this level of testing is not practical in most instances. Building ventilation can also be tested using tracers such as helium or sulfur hexafluoride (SF<sub>6</sub>), which can be released as a constant or instantaneous source. Equipment for pressure/ventilation testing is shown in Figure 3-3.



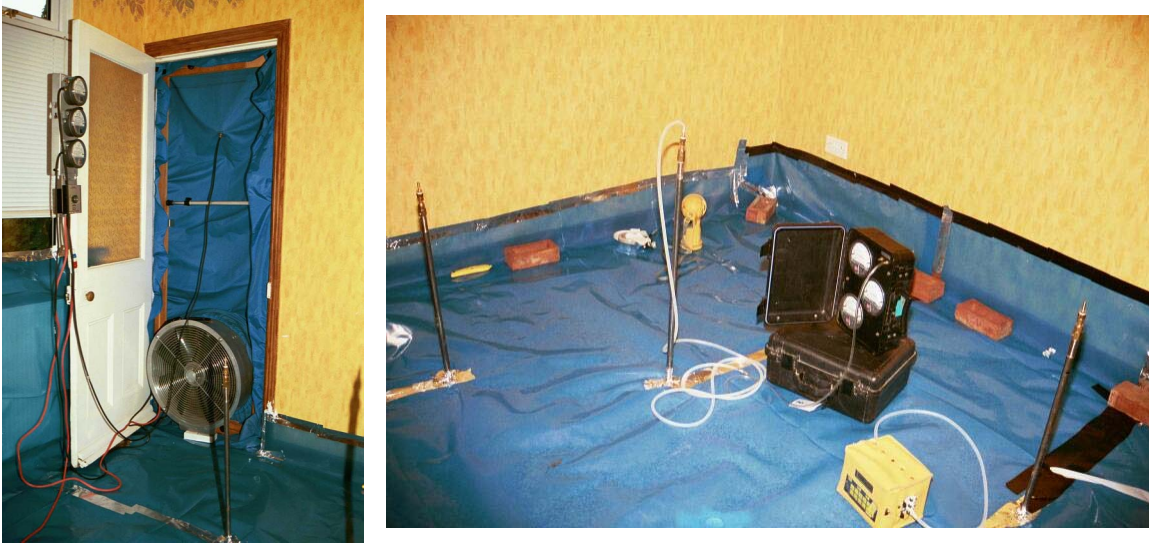

**Figure 3-3**  
**Equipment for Pressure/Ventilation Testing (McAlary et. al., 2002)**

Building ventilation has been extensively studied for energy efficiency purposes, and the results indicate that one complete air exchange typically occurs every couple of hours for a typical residence (USEPA, Exposure Factors Handbook). More than a few exchanges per hour and the house will feel drafty, and less than an exchange every few hours, and the house will begin to feel stuffy. Occupants will normally take action to correct either situation, either opening doors and windows, or sealing around them, accordingly. Therefore, default average values for the air exchange rate will usually provide a reasonable estimate of the natural building ventilation rate.

### **3.3.5 Respirometry Testing**

Aerobic degradation in the unsaturated zone can be evaluated by respirometry testing, which may be appropriate as a supplemental line of evidence in some cases, especially where aerobic degradation is critical to preventing subsurface vapor intrusion to indoor air. Respirometry testing consists of blowing a certain volume of air containing oxygen into a soil gas probe where oxygen concentrations are diminished by aerobic metabolism of VOCs, then monitoring the rate at which the oxygen is consumed and CO<sub>2</sub> produced by sampling and field screening the injected soil gas over time with a portable O<sub>2</sub>/CO<sub>2</sub> meter. The volume of air injected should be much larger than the cumulative volume of all gas purged and sampled during the test. A tracer (e.g. helium) should be added to the injected gas, and its concentration should be monitored over time to confirm that it remains steady, otherwise, the change in oxygen concentration may be attributable to subsurface gas flow or diffusion. Field tests can usually be completed in a period of a few days or less.

In many cases, the rate of aerobic degradation is essentially instantaneous compared to the rate of oxygen transport into the subsurface, so respirometry testing is not necessarily needed to demonstrate the effect of intrinsic biodegradation. Primary evidence for aerobic degradation should be vertical profiling of concentrations of VOCs, O<sub>2</sub> and CO<sub>2</sub> using nested soil gas probes. Small diameter probes and small purge volume sampling are generally best for providing the

resolution required for such discrete-depth sampling. The vertical profiles alone may provide convincing evidence of the influence of aerobic degradation. However, respirometry testing may be useful as a supporting line of evidence.

### **3.3.6 High Purge Volume Sampling**

In some cases, small purge volumes and very discrete interval sampling are not necessary and may not be desirable, especially where a very large number of soil gas probes would be required to map a soil gas distribution, and where drilling rig access is restricted. In such cases, it may be preferable to purge a large volume of soil gas from a single probe, field-screening the extracted soil gas over time and collecting selected samples for laboratory analyses. Concentrations that increase over time provide an indication of higher concentrations somewhere remote from the soil gas probe. Concentrations that remain steady over time provide some assurance that the soil gas quality is representative of an area around the soil gas probe proportional in size to the volume of gas extracted. Decreasing concentrations may indicate that the soil gas probe is installed in a location that represents a worst-case condition, although atmospheric air breakthrough may also be responsible, and may be discernable with  $O_2/CO_2$  measurements. This test can be conducted with equipment similar to that used in soil vacuum extraction pilot testing, which is generally readily available, and inexpensive. It may also be performed with existing water table monitoring wells, where the screens extend above the water table, and the permeability is high enough to allow appreciable flow rates without upconing of the water table to the top of the well screen.

High Purge Volume Sampling mixes soil gas from different depth intervals, so it may not be useful in all circumstances. For example, if vertical profiles of VOCs,  $O_2$  and  $CO_2$  are important for assessing intrinsic biodegradation, large purge volumes may result in blended samples that obscure this trend. It may also upset local equilibrium for a period of time, and subsequent sampling may require a waiting period for re-equilibration. The method is qualitative, because it does not provide precise information about the direction of vapor contributions to a well, or uniquely quantify the amount of atmospheric air that will eventually be drawn into the well screen. For this reason, it is advisable to conduct these tests on wells or probes screened some significant distance below ground surface (usually >10 feet), or isolated from the ground surface by a low-permeability layer. If naturally occurring oxygen concentrations in soil gas are diminished relative to ambient air, field screening of oxygen concentrations may also be used to assess atmospheric air breakthrough, at which stage, the High Purge Volume Test should generally be curtailed. The maximum volume for a given test should generally be no more than the air-filled porosity of a semi-sphere around the probe with a radius roughly equal to the depth of the probe's screen below ground surface.

### **3.3.7 Indoor air Sampling With and Without Subslab De-pressurization**

The relative contribution of subsurface vapor intrusion to indoor air vapor concentrations can be assessed by indoor air sampling and analysis before and during temporary application of sub-slab depressurization system (see Section 10.1.1). If the two samples show no difference in vapor concentrations, the sources of the vapors are probably interior and not attributable to subsurface vapor intrusion. This is analogous to indoor air sampling before and after building

pressurization, but may be easier to implement, because the volumetric flow rate that is required to be extracted from the subsurface to maintain a pressure differential is probably much less than the air flow into the building that would be required to accomplish the same pressure differential. Furthermore, the air blown into a building may need to be heated or cooled for occupant comfort, which may be expensive or impractical. The duration of each test stage should be sufficient for several air changes (i.e. roughly a day or more in duration).

A short-term trial of sub-slab depressurization may not be attractive to Responsible Parties, because there is a statistical chance that the results will show an improvement in the indoor air quality simply because of a coincidental reduction in background contributions. This could be avoided by repeating the test, but this would be costly, and may not be convincing to cautious occupants or regulators. Therefore, this test may be best used to resolve cases where the subsurface vapor contribution could not be clearly distinguished by routine sampling and analysis procedures.

### **3.4 Multiple Lines of Evidence**

In some cases, it may be clear that vapor intrusion is either occurring or not, based on only one line of evidence. In others, a single line of evidence may be ambiguous, in which case the confidence in the determination of whether vapor intrusion poses an unacceptable risk or not will be higher if the determination is supported by more than one line of evidence. Multiple lines of evidence is one way to quantify the uncertainties imposed by spatial, temporal, sampling and analytical variability and biases. For this reason, this Handbook attempts to discuss as many approaches as possible, to provide the practitioner with options.

In some cases, a secondary line of evidence may be identical data collected at a different location, different time, or over a different time interval. Spatial and temporal variability can often impose uncertainty of an order of magnitude (factor of 10), which may be large enough to make the determination change from negative (vapor intrusion does not pose unacceptable risks) to positive. This is particularly challenging because in many cases laboratory reporting limits do not provide more than an order of magnitude resolution below the low target indoor air concentrations.

### **3.5 Analytical Methods**

The selection of appropriate laboratory analytical methods should be made by developing a list of compounds known or suspected to be present at a given site in the subsurface at concentrations above regulatory screening levels, and discussion with a laboratory skilled in analysis of air samples. Analytical reporting limits for indoor air samples should be lower than target indoor air concentrations, unless this is technically impracticable. Analytical reporting limits for soil gas samples can be higher, because soil gas concentrations are always attenuated to some degree by building ventilation. For sub-slab samples, the reporting limits should be no more than a factor of 10 higher than target indoor air concentrations. For deeper soil gas samples, laboratory reporting limits can be slightly higher, but should not exceed 100 times the target indoor air concentration.

The target analyte list can be developed by comparison of maximum vapor concentrations to target indoor air concentrations, after allowing for a conservative degree of attenuation. The maximum vapor concentration (C<sub>max</sub>) is given by:

$$C_{\max} (\mu\text{g}/\text{m}^3) = 1,000,000,000 \times (\text{v.p.} \times \text{Mw})/(\text{RT})$$

where v.p. is vapor pressure (atm), Mw is molecular weight (g/mol), R is the universal gas constant (0.0082 L atm/mol K), and T is absolute temperature (K).

Where the C<sub>max</sub> value is not at least 100 times higher than the target indoor air concentration, the compound is probably not sufficiently volatile to pose a risk via subsurface vapor intrusion, unless there are preferential pathways from a subsurface NAPL source to the indoor air.

If sub-surface (soil gas or sub-slab) sampling and analysis is conducted prior to indoor air sampling and analysis, it may be appropriate to limit the list of analytes for indoor air samples to those compounds detected in sub-surface samples at concentrations more than target indoor air concentrations by an appropriate factor (e.g. a factor of 10 for sub-slab samples, or potentially higher factor for deeper soil gas samples, up to a maximum of a factor of 100). The goal of this screening would be to eliminate the need to validate, report, interpret, and communicate concentrations of compounds typically present in indoor air from background sources. In some jurisdictions (e.g. New Jersey), regulatory guidance may require pre-determined analytical lists, in which case, such screening may not be useful.

It may also be advantageous to include compounds that may be useful as tracers or indicator compounds, even if they do not pose a health concern, particularly if they are not common in consumer products or building materials. Such chemicals can potentially be used to determine a site-specific attenuation factor if both sub-surface and indoor air samples are collected and if concentrations are detectable in both media. If concentrations are below detection limits in indoor air samples, the data may still be useful for determining a lower bound on the amount of attenuation from sub-surface to indoor air.

Target detection limits, possible background levels, and sample volumes may all require consideration in the process of selecting the most appropriate sampling and analytical methods. EPA Methods of Analysis for Toxic Organics (TO) in air samples are as follows:

- i. Summa™ Canister Methods
  1. TO-3 (Volatile Organic Compounds [VOCs]),
  2. TO-12 (Non-Methane Organic Compounds),
  3. TO-14 (VOCs),
  4. TO-15 (VOCs),
  5. TO-15 SIM (VOCs with low detection limits)
  6. Method 18 (VOCs),
  7. ASTM D-5504 (reduced sulfur compounds)
  8. a variety of atmospheric gas methods.

- ii. Automatic Thermal Desorption (ATD) Tubes
  - 1. TO-1 (VOCs),
  - 2. TO-2 (VOCs),
  - 3. TO-4 (pesticides),
  - 4. TO-9 (dioxins),
  - 5. TO-10 (pesticides),
  - 6. TO-11 (aldehydes),
  - 7. TO-13 (Semi-Volatile Organic Compounds [SVOCs]),
  - 8. TO-17 (VOC & SVOCs),
  - 9. 8260 (VOCs) and 8270 (SVOCs)

Summa™ canisters are advantageous because they are a whole air sample, and there is often sufficient volume in the canister to repeat an analysis if there are questions. Holding times up to 30 days are often acceptable, but 14 days is preferred. Compounds heavier than 12 carbon chains (Dodecane) will tend to adsorb to the canister and not be adequately recovered.

Automatic thermal desorption (ATD) tubes or Volatile Organic Sampling Train (VOST) tubes are cylinders packed with adsorptive media through which air is drawn at a measured rate for a measured time. The mass trapped on the tube is determined by laboratory analysis and the concentration is calculated by dividing the mass by the product of the flow rate and time (i.e. volume of air passed through the tube). ATD or VOST tubes are better suited to heavier compounds, although compounds as light as vinyl chloride can be trapped, using carefully selected combinations of adsorbent media, of which there are hundreds available, and combinations are also commonly used. Therefore, an experienced analyst is required to select the appropriate media, considering the suite of chemicals to be analyzed, target detection limits and expected concentration ranges. The analyses are destructive, so it is often advisable to sample in duplicate, even if only one sample is analyzed, in order to allow an opportunity for repeat analysis, if needed. There is also a possibility that the pump might fail (e.g. battery failure), in which case, the sample would not be representative of the entire planned sampling interval, in which case the duplicate sample could avoid a repeated mobilization of the sampling crew.

Quality assurance and quality control (QA/QC) procedures should be included in the analytical method selection process. Duplicate samples at a rate of about one per 10 investigative samples will help assess reproducibility. Equipment blanks should be considered when using very low detection limits (<0.5 ppbv), or when parts of the sampling train are not new or dedicated. Ambient air samples should be included when indoor air samples are collected, and may also be useful for soil gas surveys in urban areas or areas near industrial stack emissions. Internal standards and surrogates should be employed as part of the laboratory QA/QC process, as well as batch certification for Summa™ canisters or certification of every canister if TO-15 SIM analysis is used. EPRI published a Compendium of Air Quality Monitoring Methods (EPRI, 2002) which contains details on methods, detection limits and other considerations at MGP sites.

MGP wastes typically include compounds such as PAHs that are not all amenable to sampling and analysis using Summa™ canister methods. However, although PAH compounds are present in MGP source materials, they are usually present as airborne particulates (dust). An ATD or VOST tube sample with analysis by TO-17 or TO-13 or modifications may be used if such analyses are needed based upon site-specific needs. If coal tar is known to be present at a particular site, it may be advantageous to collect soil gas samples from near the coal tar for analysis of VOCs and SVOCs (possibly including tentatively identified compounds) in advance of a site-specific assessment of vapor intrusion, simply for the purpose of developing the appropriate analytical list. If multiple mobilizations are impractical, the holding times for Summa™ canisters and ATD or VOST tubes are sufficient to allow time for the coal tar analysis to be conducted with an expedited schedule, and the analytical list for the remaining samples to be determined within the holding time limits.

Ultimately, the target analyte list, methods of sampling and analysis, reporting limits, sample volumes, and quality control/quality assurance considerations depend on site-specific factors, including the chemicals potentially present at a site, and should be decided following discussion with the laboratory performing the analyses. The list of analytes may also include indicator compounds or tracers, and compounds that pose potential analytical interferences.

### **3.5.1 Laboratory Challenges (courtesy of Air Toxics Ltd.)**

The draft OSWER Guidance and the “Advisory – Active Soil Gas Investigations” (DTSC and LARWQCB, 2003) raised many questions for the laboratories performing indoor/ambient air analysis. The draft OSWER guidance represented a shift in the laboratory industry towards reporting levels in the part per trillion by volume range for TO-15 based work. To achieve these levels, analytical laboratories must evaluate the entire analytical process to ensure that all of their quality control systems can achieve these lower values while still providing the same defensibility achieved at the part per billion by volume level. The DTSC document suggested the use of SW-846 method 8260B for soil gas analysis, and while this method may have its place, such as initial screening of a contaminated site, the compendium toxic organic (TO) methods are preferred for indoor air sampling and analysis.

The method defined reporting limit for TO-15 is 0.5 ppbv. The clean canister certification level for this reporting limit is 0.2 ppbv. The cancer slope factor for TCE was revised as a draft in August 2001, and made more stringent, such that the target indoor air concentration for a residential scenario and a  $10^{-6}$  incremental cancer risk (Table 2c of the OSWER Guidance) is 0.0041 ppbv for Trichloroethene. This is a factor of approximately 100 times lower than the levels at which TO-15 was designed to analyze. Furthermore, SW-846 8260B reporting limits are about 100 – 250 ppbv for many of the volatile compounds, depending on the molecular weight of the compound, which is a factor of almost 100,000 times higher than the most protective target TCE indoor air concentration. Clearly, this creates a new paradigm for these analyses, and a substantial challenge for the analytical methods. The toxicity of TCE is under review, but the schedule for revision is mid-2006, and in the interim regulatory policies are likely to vary between jurisdictions.

Aside from the reporting limit differences, there are some similarities between TO-15 and SW846 Method 8260B. First is that they both utilize a multi-bed sorbent dryer to dry and focus

the sample stream prior to injection onto the instrument. In this case, the instrument prescribed for each method is a GC/MS combination. However, 8260B was written for solid and liquid waste samples, and TO-15 was written for the analysis of vapor phase samples. Also, the configuration of the purge and trap unit is different for the two different methods. For 8260B analysis, the sparger vessel holds a specified volume of water. This vessel acts as a knock-out impinger for two different classes of compounds, polar analytes and heavier volatile organic compounds. The polar analytes become entrenched in the water and the heavier VOC's are trapped by the glass surface of the vessel itself.

The trap unit for TO-15 analysis uses no sparger vessel. This allows for the analysis of polar analytes as well as some heavier VOC's by method TO-15. The heavy analytes, in this case, are defined as compounds with as many as 12 carbons in their molecular structure, such as Dodecane. Compounds containing more than 12 carbon atoms do not recover well out of Summa™ canisters, the main media type used for TO-15 analysis. The following chromatograms (Figure 3-4) represent analysis of the same sample by the two different methods, the first by TO-15, the second by 8260B. Notice the loss of heavy analytes in the back end of the chromatographic profile of the 8260B example in comparison to the TO-15 example:

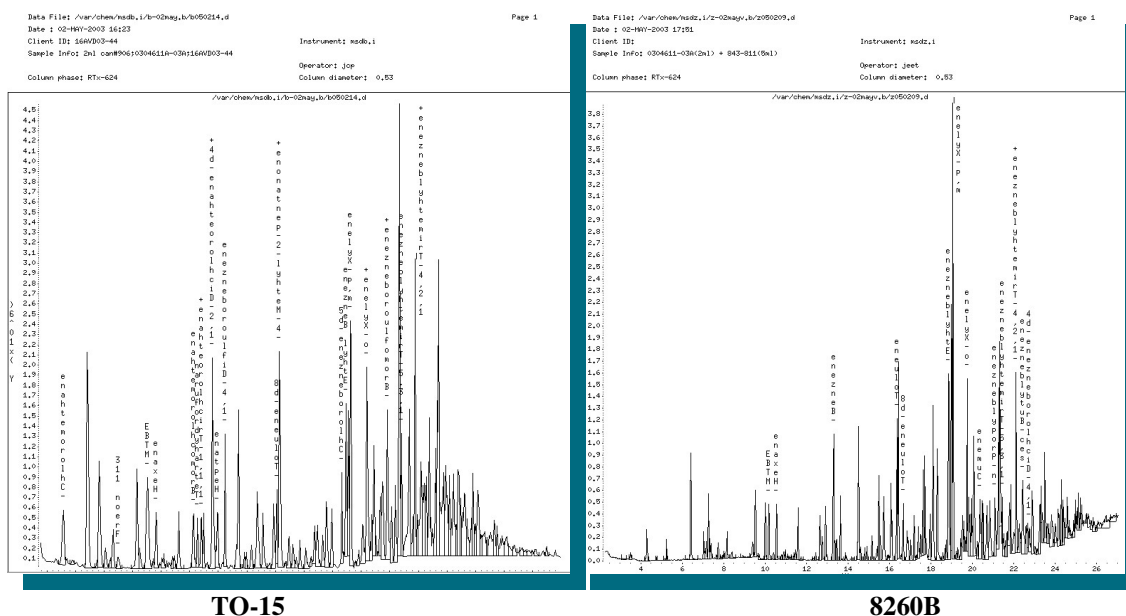

**Figure 3-4**  
**Chromatographs for laboratory analyses by Methods TO-15 and 8260B**

It is possible to modify the 8260B method to bypass or remove the sparger vessel; however, this modification is made to more closely resemble the TO-15 configuration. When analyzing vapor phase samples, the most straightforward approach is to use a vapor phase method.

This modification has to do with how the mass spectrometer operates and is found in Appendix E of the TO-15 Method document. It discusses the use of the mass spectrometer in the selected ion monitoring (SIM) mode to improve the method detection limit (MDL) study for a given set of analytes. Typically, TO-15 analysis is carried out in full scan mode. In full scan mode, the detector is constantly scanning between a given set of atomic mass units (amu) for the duration

of the analysis. For example, the upper and lower  $m/z$ 's selected may be 350 and 35. This means that the MS is bouncing back and forth between these two limits every second or two, effectively limiting the time that the detector can spend "looking" for any specific ion. When using SIM mode, the operator programs the MS to look for a specific set of ions in a specific time window. By keeping the number of ions to a minimum the sensitivity of the detector can be increased up to 100 times. This increase is needed to achieve the pptv values specified in the  $10^{-6}$  tables. It should be noted that the use of SIM is necessary based on current technology and other detectors may become available in the future to achieve these low reporting levels (RLs). Also, soil gas should generally not be analyzed using the SIM method, because of potential interferences from natural organic matter in soil.

Often in vapor intrusion work, achieving a defensible data set is of utmost importance. As discussed above, method selection is one of the most important decisions in defining data quality objectives. For vapor samples it is important to begin with a vapor phase method (i.e. a "TO" method, not an "SW-846" method). Secondly, the operation of the instrumentation should match with the type of sample being analyzed. Indoor air may be analyzed by SIM or full scan, depending on the required RL. In contrast, soil gas samples should be analyzed by full scan (reporting limit of ~0.5 ppbv) or direct injection (reporting limit of ~2 ppbv), primarily, although in some cases, it may be acceptable to conduct real-time plume mapping programs using mobile laboratories with slightly higher reporting limits, or perform initial screening or delineation using portable instruments. Whether analyzing indoor air, soil gas or another form of vapor sample, there are some basic rules to follow in order to achieve a defensible data set. The following seven rules apply to vapor phase analyses.

- 1.) Use the compendium "TO-" methods. For VOC's in air samples, this means TO-15.
- 2.) Use Summa™ canisters, or similar, for sample collection of samples for VOC analysis instead of Tedlar™ bags, glass cylinders, or other containers. This allows the samples to be pressure checked at the end of sampling and at the laboratory to ensure that the integrity of the sample has not been compromised in transit. Canisters can also be certified prior to sampling. For any projects in the pptv range, 100% certification of all sampling equipment is recommended. Summa™ canisters may not be appropriate for SVOCs, PCBs, or other high molecular weight compounds that may be sufficiently volatile and toxic to pose a potential vapor intrusion risk, in which case, ATD tube sampling and analysis by TO-13A, TO-17, TO-1 or other methods may be required.
- 3.) Use a 14-day holding time for Summa™ canister samples. TO-15 specifies a 30-day hold, but 14 is most commonly accepted.
- 4.) The laboratory should use vapor phase standards for calibration of the instruments. This will be the most accurate representation of the sample being collected in the field.
- 5.) Sample analysis should be conducted using a NIST-certified, leak free, gas phase introduction system. This ensures the sample is transferred from the canister to the instrument without loss and without any background contribution.
- 6.) Add the internal standards and surrogates to the vapor sample before it reaches the sample concentrator. The internal standards are used in a mathematical formula to calculate the results and the surrogates are used as a quality control parameter to evaluate recovery of analytes through the analytical system. If these two components do not follow the same analytical path of the sample, then they are not truly representative of that sample.



- 7.) Use as many of the quality control parameters from TO-15 and NELAP as possible. NELAP is a national accreditation program for environmental laboratories, which is based on ISO standards. The goal of NELAP is to provide the end data user with a consistently high quality analytical product.

Each of the above rules, when used in conjunction with each other and in combination with a well defined project with clear data quality objectives has the highest possibility for success in meeting the stated needs of the project.

However, there are equipment limitations that also play a role in meeting the defensibility goals of an analytical project. Canisters for air sampling are designed for analysis at levels around 100 pptv or greater. As laboratories continually strive to meet lower and lower RL's as defined by regulatory documents or other sources, it becomes essential to evaluate the media used for sample collection. The first question, when considering canisters, is can they be cleaned and certified to the levels at which the analysis will be carried out. In a laboratory setting, tens of thousands of canisters may be cleaned in a given year, providing a large set of data for evaluating the ability to clean canisters to pptv levels. In a QA/QC test performed by Air Toxics of Folsom, CA, 2200 canisters were cleaned and certified at the TO-15 specified level of 0.2 ppbv for several VOC's. Canister failure rates for Benzene were evaluated. Of these initial 2200 canisters, only one canister failed the 0.2 ppbv criteria. A 100 canister subset of these 2200 was subsequently evaluated at pptv levels. Of these, every one had a positive result for Benzene at pptv levels. The following table displays the certification data for Benzene as well as for Vinyl Chloride, Trichloroethene, and Tetrachloroethene:

	Number of results in 100 canisters	Average ppbv/can	Highest ppbv
Vinyl Chloride	0	Not Detected	Not Detected
Benzene	100	0.014	0.158
TCE	79	0.010	0.259
PCE	30	0.009	0.043

Another potentially significant equipment limitation for analysis with very low detection limits such as SIM is diffusion of VOC molecules out from the dead volume in the valve structure or by other structural limitations of the canisters, resulting in the mass of a contaminant in a canister increasing over time without being exposed to the sampling environment. This may be referred to as a "virtual leak". The following table provides data from a study performed by Air Toxic Limited to show how the virtual leak concept can impact analysis at the pptv level. Seven canisters were cleaned and certified to 3 pptv for TCE and PCE. These canisters were evacuated and left to rest with the valves closed. Ten days later the canisters were filled with ultra high-

purity nitrogen and analyzed by Method TO-15 SIM to determine the final concentration of these two compounds.

Day 1	(pptv)	(pptv)	(pptv)	(pptv)	(pptv)	(pptv)	(pptv)
TCE	ND	ND	ND	ND	13	ND	ND
PCE	ND	ND	ND	ND	3.9	ND	ND
Day 10							
TCE	ND	ND	ND	ND	21	ND	ND
PCE	ND	ND	ND	ND	5.8	ND	ND

As shown, canister 5 demonstrated a significant increase in concentration of both TCE and PCE. This increase is beyond any variance inherent in the analytical method. This virtual leak concept does not impact work at the ppbv level, but may provide a mechanism for false positives at the pptv level. One positive outcome of this study was that all canisters with concentrations below 3 pptv on Day 1, also had concentrations below 3 pptv on Day 10.

### 3.5.2 Field Screening Considerations

Field screening is an important part of any site-specific assessment of subsurface vapor intrusion to indoor air. Screening may be used for rapid assessment of potentially explosive conditions (landfill gas meter), to confirm that soil gas purging is producing reproducing soil gas samples (FID or PID), to identify rooms within a house that might potentially be contributing background vapors (FID, ppbRAE™ or TAGA), to confirm the integrity of samples through the use of tracers (He, SF6), or to assess biodegradation (O<sub>2</sub>/CO<sub>2</sub>). Field laboratories may also be used to provide real-time data that can be used to make interactive scoping decisions, especially where the number of planned analyses is sufficient to justify the mobilization, and/or the characterization schedule is tightly constrained. Calibration for field instruments should be performed carefully and regularly when they are used for vapor intrusion assessments, where low concentrations are the primary concern. Calibration checks under field conditions are also especially important, and should be documented along with the field screening data in case drift corrections are appropriate. General information about various instruments is provided below, with no endorsement of any particular brand names or products intended or implied.

### PIDs and FIDs for VOC Screening

PIDs and FIDs are both capable of detecting VOCs, but some care must be used in the selection of the appropriate instrument for a particular site, depending on the types of compounds present, the expected concentration ranges, and the presence of any potential interferences. PIDs come with lamps of different power levels (e.g. 10.3 and 11.7 eV), and the lamp must have a power level higher than the ionization potential of the compound(s) of concern to be useful. PIDs can be sensitive to water vapor, and soil gas is generally humid, so a water trap is recommended,

especially when the air temperature is lower than the ground temperature, and the risk of condensation is increased. FIDs are not sensitive to water vapor, but they require a source of hydrogen gas to fuel the flame, which may be a prohibited material at some sites for safety reasons. Manufacturer's instructions should be very carefully followed, especially maintenance and calibration instructions.

Calibration gases for FIDs and PIDs may include both span gas (typically 50 ppmv hexane or isobutylene), and zero gas (certified clean air) in areas where ambient outdoor air quality is poor enough to potentially bias the calibration process. Dedicated Tedlar™ bags should be used for each calibration gas. Calibration should be done on-site, every day, and checked several times each day as a guard against possible instrument drift. Recalibrations should be performed if significant drift is observed ("significant" may vary from instrument to instrument, but generally more than 10% drift for span-gas readings, or more than 1 ppmv drift on zero air readings should be justification for recalibration). Replicate and duplicate readings are inexpensive with field instruments and should be performed regularly to assess the consistency and variability in readings.

Soil gas samples for field screening should be drawn into the field instrument via a Tedlar™ bag at ambient pressure, identical to the conditions used for the calibration gases. If the bag is squeezed, it will force flow past the detector at an accelerated rate and cause a positive bias in the reading. If the field instrument is connected to a soil gas probe directly, the flow rate may be reduced if the subsurface materials are not highly permeable, which would cause a negative bias. It may also draw soil moisture into the instrument, leading to costly maintenance. A vacuum chamber or "lung-box" is preferred for filling a Tedlar™ bag, to avoid potential cross-contamination through pumps.

In general, hand-held PIDs provide reproducible total VOC readings within the range of 1 to 10,000 ppmv. FIDs can provide reproducible readings at somewhat lower concentrations, but still generally above 0.1 ppmv. A relatively new instrument (the ppbRAE) is advertised to provide total VOC readings as low as 10 ppbv. Target indoor air concentrations are generally lower than these instruments are capable of detecting, but they may be useful for soil gas screening. For example, Massachusetts considers PID screening of sub-slab soil gas samples as a valid approach for assessing the potential for sub-surface vapor intrusion to indoor air.

## Z-Nose™

There is an electronic nose, called the zNose™ (Watson et. al, 2003) that is able to speciate and quantify the individual chemicals present in 10 seconds with part per billion sensitivity using only a single sensor. Simultaneously, the zNose™ can produce high-resolution visual olfactory images, called VaporPrints™, and hundreds of virtual chemical sensors as well. The zNose™ can perform over 400 measurements per day, operates over a range of vapor concentrations spanning 8 order of magnitude, has ppb or better sensitivity, is simple to use, and maintains calibration over extended periods of time. the zNose™ contains only a single patented sensor, a programmable gate array (PGA) to control the sensor and a direct heated 1 meter length of capillary chromatography column. Amerasia Technology Inc, a California R&D corporation, is responsible for inventing the zNose™. The company currently has 2 issued and 2 pending

patents. EPRI has conducted, or has been involved in, several studies using the Z Nose™, including a side-by-side comparison with other portable devices (see EPRI(2003, 2004)).

### Landfill Gas Meters for O<sub>2</sub>, CO<sub>2</sub> and CH<sub>4</sub>

Landfill gas monitors are available to quantify methane, carbon dioxide and oxygen concentrations to low percent levels. The Landtec GEM 500™ also monitors gas flow rate, BTU content, temperature, pressures and lower explosive limit (LEL). Landfill gas meters are useful for field screening of soil gas prior to sample collection to confirm steady readings, much as specific conductance, temperature, turbidity and dissolved oxygen are used for monitoring groundwater purging prior to sample collection. At sites with aerobically degradable compounds (especially hydrocarbons), it is common to find soil gas with oxygen concentrations that are clearly lower than atmospheric levels, and carbon dioxide concentrations that are clearly elevated above atmospheric levels. The detection limits for these instruments is commonly in the low % range (rather than ppm or ppb), but this nevertheless provides ample resolution for field screening for these parameters.

### SF<sub>6</sub> and He Meters

Helium and sulfur hexafluoride (SF<sub>6</sub>) are the most commonly used tracers for air flow and building ventilation testing. Helium is inexpensive, readily available, non-toxic, and easily detected in the range of 0.01 to 100% using portable helium meters, which provides 4 orders of magnitude resolution for tracer testing. Helium is very useful for leak testing, such as where a small volume of helium is sufficient to test seals in sampling trains.

SF<sub>6</sub> meters (e.g. Brüel & Kjaer (B&K) multigas photoacoustic analyzer, model 1302) are sensitive to much lower concentrations (~100 ppbv), and the Lagus instrument can detect down to about 0.001 ppbv so much less tracer gas is required; therefore, SF<sub>6</sub> is a preferred tracer when testing air flow in large volumes (e.g. entire building ventilation tests, as described by Howard-Reed et al, 2002).

### Mobile Laboratories

Mobile laboratories for soil gas surveys have been available in various forms for almost two decades, however, in many cases, the reporting limits were in the range of 1,000 µg/m<sup>3</sup> (roughly 200 ppbv for many VOCs), which is considerably higher than fixed laboratory reporting limits (e.g. 0.5 ppbv for EPA Method TO-15). Recent advances in mobile laboratory technology have enabled TO-15 analyses to be performed by mobile laboratories, provided strict QA/QC protocols are followed. Mobile laboratories offer the advantage of real-time information, which can be used to guide the scope of site-assessment activities and in many cases provide adequate site characterization in a single mobilization, instead of multiple phases.

## Mercury Meters

The Ohio Lumex RA-915+ Portable Mercury Vapor Analyzer is capable of detecting mercury vapors at concentrations as low as 0.002 µg/m<sup>3</sup>, which is lower than the target indoor air concentration for residential exposure at the 10E-6 incremental cancer risk level (0.3 µg/m<sup>3</sup>, OSWER Guidance, Table 2c); therefore, this instrument would be useful for field screening of indoor air, or subsurface vapors. The Jerome 431-X Mercury Vapor Analyzer has a detection limit of 3 µg/m<sup>3</sup>, which would be useful for screening sub-surface vapor samples.

## TAGA

The Trace Atmospheric Gas Analyzer (TAGA) unit is a mobile laboratory owned and operated by EPA, and available for use by regulatory agencies for on-site, real-time analysis. The TAGA unit uses a dual quadrupole mass spectrophotometer that can continuously quantify concentrations of selected compounds in an air-stream drawn through a long hose to low parts-per-trillion levels. Air quality can be assessed for individual rooms within a building, or even localized areas within a room (near storage of cleaning products, floor drains, etc.). The TAGA unit is the current state-of-the art in field screening capability, but is currently only available to regulatory agencies, and not private enterprises.

## Portable PTR-MS

PTR-MS (Photon Transfer Reaction – Mass Spec.) systems are available in a portable configuration and as fixed laboratory instruments, with capability of monitoring VOCs and SVOCs with sub-ppbv detection limits, in some cases as low as a few parts per trillion (ppt). Useful insights on presence of trace compounds and other analyses is currently a subject of research. EPRI has used, and continues to use the methods in special situations requiring sub-ppbv resolution, but method validation at these levels continues to be a challenge for the investigators (EPRI, 2003/2004).



# 4

## MATHEMATICAL MODELING

---

Mathematical modeling can help develop an understanding of the significance of various fate and transport processes, compare expected performance of various remedy designs (if needed), and possibly act as an additional line of evidence or interpretive tool. In general, a screening level model for a given set of site conditions can be performed quickly, so it is usually appropriate to conduct a few simple bounding calculations to assess “best-case” and “worst-case” conditions. If vapor intrusion is significant in both cases, it may be preferable to proceed toward remedy design than an expensive investigation. Conversely, if vapor intrusion is insignificant in both cases, it may be possible to select a focused scope of investigation, and use the model calculations as a supporting line of evidence. Screening level models will generally provide results that are similar to measured conditions, but considering the spatial, temporal, sampling and analytical variations, uncertainty in model inputs, and limitations of simplistic model formulations, it should not be surprising if measurements and model outputs show discrepancies of approximately one order of magnitude.

One of the most valuable uses of mathematical models for vapor intrusion is to be able to estimate indoor air concentrations from subsurface vapor concentrations at some depth. If the indoor air concentration can be calculated, it may not be necessary to collect indoor air samples, or it may be easier to resolve background contributions. For this reason, vapor intrusion models are often formulated to calculate the indoor air concentration, or the attenuation factor from subsurface to indoor air. For example, Johnson and Ettinger (1991) defined the attenuation factor ( $\alpha$ ):

$$\alpha = \frac{\left[ \frac{D_T^{eff} A_B}{Q_B L_T} \right] \exp\left( \frac{Q_{soil} L_{crack}}{D_{crack}^{eff} \eta A_B} \right)}{\exp\left( \frac{Q_{soil} L_{crack}}{D_{crack}^{eff} \eta A_B} \right) + \left[ \frac{D_T^{eff} A_B}{Q_B L_T} \right] + \left[ \frac{D_T^{eff} A_B}{Q_{soil} L_T} \right] \left( \exp\left( \frac{Q_{soil} L_{crack}}{D_{crack}^{eff} \eta A_B} \right) - 1 \right)}$$

Where:

$A_B$  = the surface area of the enclosed space in contact with soil [ $m^2$ ]

$\alpha$  = ( $C_{indoor}/C_{source}$ );  $C_{indoor}$  denotes the indoor air concentration and  $C_{source}$  is the vapor concentration at some depth (both in consistent units)

$C_{indoor}$  = the indoor air concentration [ $\mu g/m^3$ ]

$C_{\text{source}}$  = the vapor concentration at some depth, or the vapor concentration calculated to be in equilibrium with contaminated groundwater [ $\mu\text{g}/\text{m}^3$ ]

$D^{\text{eff}}$  = the effective overall vapor-phase diffusion coefficient [ $\text{m}^2/\text{d}$ ]

$D_{\text{crack}}^{\text{eff}}$  = the effective overall vapor-phase diffusion coefficient through the walls and foundation cracks [ $\text{m}^2/\text{d}$ ]

$D_{\text{T}}^{\text{eff}}$  = the effective overall vapor-phase diffusion coefficient between the foundation and the depth  $L_{\text{T}}$  [ $\text{m}^2/\text{d}$ ]

$E_{\text{B}}$  = the building air exchange rate [ $\text{d}^{-1}$ ]

$\eta$  = the fraction of enclosed space surface area open for vapor intrusion [ $\text{m}^2/\text{m}^2$ ]; this is sometimes referred to as the “crack factor” and is estimated to be the total area of cracks, seams, and any perforations of surfaces in contact with soil divided by the total area in contact with soil.

$L_{\text{crack}}$  = the enclosed space foundation thickness [m]

$L_{\text{T}}$  = the distance (depth) to the vapor source or other point of interest below foundation [m]

$Q_{\text{B}}$  = the enclosed space volumetric air flow rate [ $\text{m}^3/\text{d}$ ]; usually estimated to be the product of the enclosed-space volume ( $V_{\text{B}}$  [ $\text{m}^3$ ]) and the indoor air exchange rate ( $E_{\text{B}}$  [ $1/\text{d}$ ])

$Q_{\text{soil}}$  = the pressure-driven soil gas flow rate from the subsurface into the enclosed space [ $\text{m}^3/\text{d}$ ]

$V_{\text{B}}$  = the enclosed space volume (i.e., the volume of the basement or first floor room of a slab-on-grade construction) [ $\text{m}^3$ ]

This is a screening-level model that considers 1-dimensional upward diffusion from a subsurface source through the unsaturated zone, advective flow into the building through a foundation crack due to under-pressurization, and dilution in the building ventilation. The J&E (1991) Model does not consider biodegradation (added in Johnson, et al., 1998), barometric pumping (see for example Parker, 2003), preferential pathways, fractured subsurface media, or other processes that may be important in some circumstances; therefore, it may not be applicable without modification in some circumstances.

The J&E Model was programmed into user-friendly spreadsheets (EQM, 2000) and is available in multiple versions for soil, groundwater or NAPL sources and layered or homogenous subsurface material properties as a free download from the EPA website at the URL [http://www.epa.gov/superfund/programs/risk/airmodel/johnson\\_ettinger.htm](http://www.epa.gov/superfund/programs/risk/airmodel/johnson_ettinger.htm). The mathematics



for incorporating biodegradation as a filtering parameter using site-specific field data has been developed (Johnson et al., 1998), but not yet incorporated into the EPA spreadsheets.

A distinction should be made between the J&E (1991) Model and the EPA spreadsheet implementation of the J&E Model. The former is simply an algebraic expression for the attenuation coefficient or alpha factor. The latter incorporates default values and exposure assumptions to enable calculation of a risk for a certain set of conditions, or a cleanup standard for a specified risk level. Default values in the latter were revised in 2002 to be consistent with assumptions used in generating Figure 3 in the OSWER Guidance (EPA, 2002). During the comment period on the OSWER Guidance, some of the revised default values were criticized as being overly conservative; however, these changes may be justified because the model output with the revised default values more closely matches empirical (measured) attenuation factors.

The EPA spreadsheet implementation of the J&E (1991) Model consists of 8 primary and 12 secondary input parameters, many of which will not typically be measured during a site-specific investigation. Many of the parameters do not need to be measured, either because they can be reasonably estimated, or because the model results are insensitive to the parameter values within reasonable ranges. The critical parameters in the J&E Model are described in a recent publication by Johnson (2002), which includes a decision-tree that leads the user to identify the critical inputs for their specific site. The EPA spreadsheets are in the process of being revised to incorporate some of the Johnson, 2002 recommendations. It also recommends assigning a  $Q_{soil}/Q_{building}$  ratio, in the range of 0.02 to 0.0001. This range is the common range for the sub-slab to indoor air attenuation factor, which should be equal to the ratio of  $Q_{soil}/Q_{building}$ , providing there are no background sources of a given compound.

Several other models have been developed for assessing subsurface vapor transport and/or vapor intrusion to indoor air. Krylov and Ferguson (1998) created a model that is designed for buildings with suspended timber floors or crawlspaces. The model Volasoil (Waitz, et. al, 1996) was developed in the Netherlands for assessing vapor intrusion, and is noteworthy because it specifically addresses buildings with crawlspaces, which is a relatively common design, and is not specifically addressed by the J&E model. A discussion of several European models is contained in EPRI, 2004

A 3-D numerical model for vapor intrusion was recently developed at Arizona State University (Abreu and Johnson, 2004, in press ES&T), which is the most comprehensive model for vapor intrusion available to date. Unfortunately, this model is complex and not yet commercially available, so the practicality for most site-specific assessments would be limited. Nevertheless, these comprehensive models provide continued improvement to the general understanding of the processes affecting subsurface vapor transport mechanisms. Plans to further support the validation and use of this model in easy-to-use format is being discussed with these investigators by EPRI.

Subsurface vapor transport (without explicit simulations of buildings) can be simulated with Air3D (Joss and Baehr, 1995), VapourT (Mendoza and Frind, 1990a,b), and a multiphase model by Sleep and Sykes (1989). Lowell and Eklund (2004) used mathematical modeling to assess the distance from a source that vapor intrusion could occur at levels of concern.



# 5

## STRATEGY FOR PHASED APPROACH TO SITE-SPECIFIC ASSESSMENT

---

In environmental site assessments, it is often advantageous to conduct an initial round of fast and inexpensive data collection to provide some initial clues with which to begin formulating a strategy for a more comprehensive assessment, if needed. In vapor intrusion assessments, however, this is often not advisable, primarily because any indoor air sample is highly likely to contain dozens of detectable chemicals, some of which may be present at concentrations above target levels, regardless of whether they are from the subsurface or a myriad of background sources (environmental tobacco smoke, automotive fuels or exhaust, consumer products, building materials, or outdoor air). In this scenario, the vapors may be inappropriately attributed to subsurface vapor intrusion, potentially requiring considerable investigation to determine the root cause. A systematic approach to developing a strategy for assessment is recommended as described in this chapter, and outlined in the flowchart on Figure 5-1, and list of details to consider in Figure 5-2.

### 5.1 Planning

Assuming that there are no imminent risks (explosions, acute health effects), it is usually advisable to begin with a thorough planning step. This step could include gathering readily available existing information, formulating an initial conceptual model, establishing a scope for an initial phase of investigation, and developing a logical plan for future directions in response to the probable range of outcomes. Having a clear and logical plan will facilitate communication with regulators, and will help to avoid unnecessary effort. A conceptual model should be initiated as early as possible in the process, and screening level mathematical modeling is often valuable in early stages as well. Both the conceptual and mathematical models will naturally be improved over time as additional information is progressively added, but the changes are usually incremental. Developing a Work Plan can help to ensure that all these issues are addressed. The Work Plan should include a rationale or logic for how the data will be interpreted, including the basis for the indoor air quality target, any threshold above which an interim action will be required, whether confirmatory sampling will be required if concentrations are all below target levels. A communications plan may also be appropriate.

### 5.2 Focused Investigations

It may be appropriate in some cases to focus the characterization on one particular aspect of the pathway, especially where there is reason to believe that a particular process is effectively preventing subsurface vapor intrusion, and a limited scope of work can be conducted to demonstrate this with sufficient confidence. Even where a focused investigation may not be

conclusive, it may be worth an initial stage of characterization, prior to a more comprehensive approach because it may yield valuable information for scoping subsequent phases. Possible scenarios to consider for focused investigation include:

- If the compounds are aerobically degradable, it may be reasonable to begin the assessment with a program of data collection particularly designed to evaluate the locations, and extent of biodegradation, perhaps through a transect of vertical soil gas profiles for concentrations of O<sub>2</sub> and CO<sub>2</sub>, with VOC analyses.
- If off-gassing from groundwater is the suspected source of vapors to the unsaturated zone and there is a reasonable potential for a fresh-water lens, it may be reasonable to begin with shallow groundwater and deep soil gas sampling, simply to assess whether and in what areas there may or may not be any significant off-gassing from the water table.
- If a commercial building is ventilated with rooftop HVAC units, it may be reasonable to begin with an interview of the facilities engineer to assess HVAC operations, ventilation rates, seasonal changes in operating parameters, and possibly a series of micro-manometer pressure differential readings across the floor slab, extending over a series of barometric pressure cycles to assess whether the building is sufficiently pressurized to prevent vapor intrusion (i.e. comparable to the 6 to 9 Pa pressure differential recommended in the ASTM guide for radon mitigation systems).
- A focused investigation of any suspected preferential pathway may often be appropriate in advance of a site-specific investigation. For example, if VOCs were known or suspected to have been released through a sewer line, a focused investigation of the sewer pipe and surrounding backfill may be an appropriate initial step. If the sewer line or surrounding backfill contributes unacceptable vapors, a targeted response (cleaning, sealing, venting, etc) may be worthwhile, and it may be preferable to conduct any further investigations after resolution of any preferential pathway issues.
- If commercial or industrial activities in the building involve the use of the chemicals of concern and exposures to occupants are regulated by occupational health rules, then occupational standards (PELs) may be appropriate.
- If other sources are present, it may be appropriate to collect samples to test for their contribution, to aid in establishing multiple lines of evidence.
- If the building design is intrinsically safe (i.e houses on stilts, trailers without skirts, positively pressurized buildings), the vapor migration pathway may be incomplete.

Further stages of investigation may or may not be required, depending on the outcome of any one of these strategic focused investigations.

### **5.3 External Investigations**

If a focused investigation is not an option, or is inconclusive, a more comprehensive investigation may be required. The level of detail will depend on site-specific conditions; however, it is generally good to consider a broad range of possibilities and document the rationale for any items excluded from the scope of investigation.

One key decision for vapor intrusion assessments is whether to map target compound concentrations from the source forward or the receptor backward. Most often, it is preferable to map from the source forward by beginning with external investigations (i.e., data collection that does not involve entering the building). An appropriate first step would include characterizing soil gas concentrations in proximity to the known or suspected sources of vapors. If such a survey identifies concentrations of potential concern, additional activity may be appropriate to delineate the extent of soil vapors at concentrations of potential concern. If source concentrations are too low to pose a potential concern for indoor air quality, the scope of any further phases or confirmatory monitoring can be curtailed appropriately. Source area investigations should generally be designed to provide basic information regarding the compounds present, their relative concentrations, possible presence (and distribution, if possible) of NAPL, and temporal variability through periodic monitoring in select locations. A survey of this nature is usually sufficient to provide preliminary data for screening level modeling, which should initially be conducted with conservative estimates of input parameters. A sensitivity analysis can be conducted on key parameters to assess whether they impose sufficient uncertainty to justify additional data collection to refine their ranges. Additional data that may be collected to evaluate the contaminant vapor migration potential include geologic properties (e.g., permeability, moisture content) that may be used in screening models, biodegradation assessment information, and building ventilation and pressurization evaluation. The site conceptual model should be updated as appropriate after these additional data are collected.

The strategy for a site-specific assessment should also consider QA/QC samples, analyte lists, detection limits, sampling and analytical methods (including potentially mobile laboratories), background levels sample locations, durations, frequency, security, integrity, site access agreements, drill rig accessibility, and underground utility locations.

## **5.4 Internal Investigations**

If site-specific assessments of the source and distribution of soil vapors indicate the potential for vapor intrusion, further characterization may be appropriate that requires a sampling team to enter a building (i.e., “internal investigations” on the flow chart in Figure 5-1). A detailed survey questionnaire should be prepared for the sampling team to fill out with the building occupants (see Appendix A). The questionnaire should include occupants’ activities that might affect indoor air quality, building design and ventilation, inventory of consumer products that may contain VOCs, and the like. Additionally, instructions to the building occupants should be prepared and disseminated in advance of field sampling activities (see Appendix B). Along with each indoor air sample, there should be careful documentation of the conditions associated with the sample, which may be best accomplished using a form such as the one provided in Appendix C. To the extent practicable, consumer products that might release VOCs or SVOCs are best removed from the buildings and attached garages at least a day prior to indoor air sampling events.

The scope of internal investigations should be considered carefully before implementation, because of the inconvenience to occupants associated with return visits. It may be prudent to collect more data than the minimum thought necessary, in order to minimize the potential for return visits. For example, it is often appropriate to collect sub-slab samples before collecting indoor air samples, since the pathway may be deemed incomplete if the sub-slab soil gas

concentrations pose no significant risk to indoor air. This would avoid the potential dilemma of having to explain the source of chemicals that presumably would be detected in the indoor air samples. Supplemental monitoring of barometric pressure and the pressure differential from the sub-slab to indoor air would be a useful addition, particularly if it demonstrated that barometric pressure was falling during the sampling event and the sub-slab soil gas was therefore positively pressurized relative to the indoor air. If the converse was true, the sub-slab data could arguably be negatively biased due to flow of indoor air into the subsurface in response to barometric pressure increases. In some cases, it may be preferable to collect a comprehensive set of data, including sub-slab, indoor, and outdoor air samples, barometric pressure and pressure differentials, as well as information on the building design, ventilation, possible interior sources, and occupants' activities in a single mobilization. This may also be advantageous if temporal variations or trends are important because the data will all be coincident.

The scope of the internal investigations should also be carefully considered in terms of how many buildings would be included. Sometimes it is sufficient to sample select buildings located over the core of the subsurface plume. If the distribution of subsurface vapors has been adequately mapped, there may be sufficient information with which to justify a "primary" investigative zone (most likely to have vapor intrusion at unacceptable levels), a "secondary" zone (unlikely to have unacceptable vapor intrusion, but included in the monitoring program as a precaution to account for spatial variability and subsurface heterogeneity), and a "tertiary" zone which would not be monitored unless nearby properties in the secondary zone are found to have unacceptable vapor intrusion.

In some cases, it may be more practical to proceed with a remedy in lieu of further investigation. In other cases, the evidence may be so compelling that a single line of evidence is sufficient to demonstrate that the pathway is incomplete.

## Site-Specific Investigation of Subsurface Vapor Intrusion

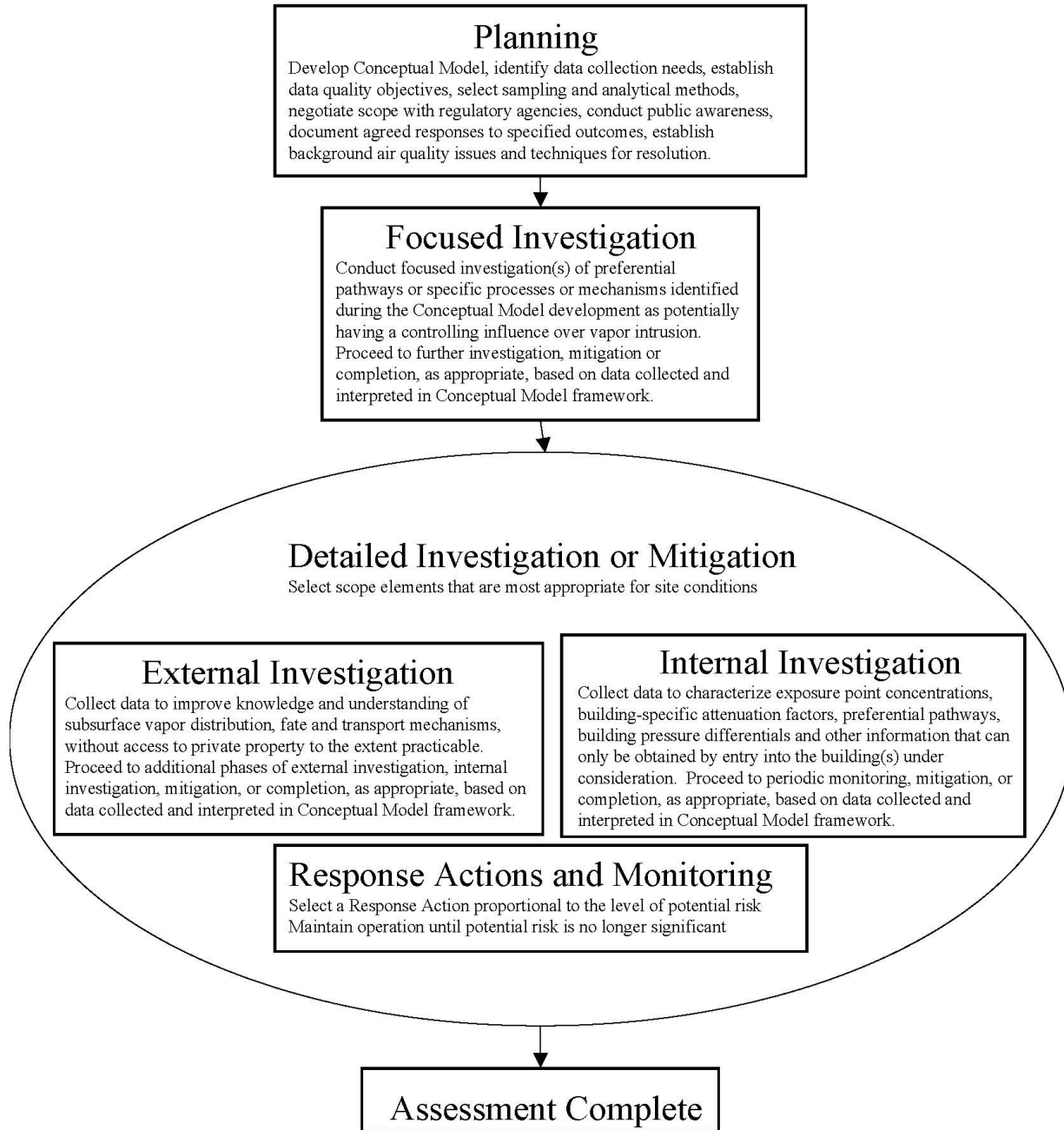

**Figure 5-1**  
**Generic Strategy for Site-Specific Assessment of Subsurface Vapor Intrusion**

# Site-Specific Investigation of Subsurface Vapor Intrusion

## Planning

Comparison of existing groundwater and soil gas data to screening levels  
Ranking of chemicals of potential concern in order of concentration/screening levels  
Development of a preliminary Conceptual Model of Fate, Transport, Exposure & Risk  
Screening Level Mathematical Modeling  
Establishment of relevant background concentrations for COPCs  
Regulatory Negotiation: establish in advance the response if IAQ > target, but no vapor intrusion confirmed  
Public Awareness: Fact Sheet, Meeting, Surveys, Instructions to Occupants During Sampling  
Selection of Scope and Methods for data collection to satisfy components listed below  
Development of Work Plan & Sampling /Analysis Plan, Regulatory Review

## Focused Investigations

Building Pressure – pathway incomplete if indoor air pressure is always >6 to 9 Pa above sub-slab pressure  
OSHA PELs - where applicable, revise screening levels for vapor intrusion accordingly  
Intrinsically safe buildings - buildings on stilts, with radon systems, landfill gas systems, etc.  
Barriers - geologic layers that result in perched water, fresh-water lenses, or other such features  
Proactive remediation - it is sometimes easier to install a radon-type system that to conduct an assessment  
Preferential pathways - focused testing, sealing, venting or similar  
Other site-specific conditions fresh paint, new carpets, floor-tile glues, mothballs, smoking

## External Investigations

Source Characterization: phase(s), constituents, concentrations, mass, distribution, depth, etc.  
Delineation of extent of soil VOC vapors at concentrations above site-specific screening levels  
Characterization of soil properties: gas permeability, moisture content, foc, texture, soil classification  
Characterization of biodegradation for aerobically degradable compounds: O<sub>2</sub>, CO<sub>2</sub>, and VOC profiles  
Assessment of building ventilation, pressurization (commercial buildings especially)  
Focused Studies of specific processes (preferential pathways, vapor barriers, radon tracer, etc.)  
Interpret Data, Revise Conceptual Model & screening level mathematical model accordingly  
Determination of potential for unacceptable vapor intrusion (and report, if appropriate)

## Internal Investigations

Removal of cleaners, fuels, solvents, aerosols, fumigants, glues, air-fresheners, smoking  
Review of Instructions to Occupants, pre-sampling survey, fact sheets, access agreements  
Optional field screening of preferential pathways with FID, PID, ppbRAE, field GC or explosimeter  
Sub-slab soil gas sampling, pressure differential monitoring, barometric pressure monitoring  
Indoor air quality samples, coincident with sub-slab samples and pressure differential monitoring  
Outdoor air samples, replicates, duplicates, control homes, and possibly other QA/QC (interlab, etc.)  
Data review, cause & effect correlations, QA/QC, validation, verification, comparison to DQOs  
Comparison of validated data to background and outdoor quality  
Fingerprinting, compound ratios, multi-linear diagrams, check if alpha factors vary with concentrations  
Risk Assessment, Regulatory negotiation, public communications and reporting, as appropriate

## Response Actions and Monitoring

For measured or calculated indoor air concentrations attributable to vapor intrusion:  
>LEL, STEL, or IDLH - evacuate immediately, ventilate before re-entry  
> PEL - don respirator or evacuate, take measures to reduce concentrations immediately  
>ASTDR Acute MRL - prohibit exposures of >1 day  
>ASTDR Intermediate MRL - prohibit exposures of > 2 weeks  
>ASTDR Chronic MRL - prohibit exposures > 1 year  
>10X target indoor air quality (TIAQ) - mitigate concentrations  
>0.1 but < 10X TIAQ - confirmatory monitoring, mitigate concentrations confirmed to be >TIAQ  
< 0.1X TIAQ - no further action  
Confirm operations of mitigation systems through pressure differentials >6 to 9 Pa

**Figure 5-2**  
**Details of Scope Elements to be Considered in Generic Strategy**



# 6

## SUGGESTED METHODS FOR DATA COLLECTION

---

Considering all of the issues identified and discussed in the preceding chapters, there is a need to ensure that data collected for assessing the vapor intrusion pathway are as representative, reproducible, and reliable as possible. With that intent, this chapter discusses methods for sample collection designed to assure data integrity to the extent possible regardless of site conditions. The methods are presented in sufficient detail to minimize potential variation between sampling teams. While there is a risk that these methods may be considered too detailed, the level of detail was developed based on decades of experience considering a myriad of factors that might influence data quality, and the possibilities are so numerous as to justify erring on the side of too much detail, rather than too little.

This chapter provides a discussion of the rationale and justification for key elements of the methods. Site-specific conditions may vary sufficiently that one rigorous method may not be applicable in all circumstances. The rationale in this chapter should assist the practitioner in making decisions regarding any changes that may be required to accommodate site-specific conditions.

### 6.1 Soil Gas Sampling and Pneumatic Testing

Soil gas sampling in general consists of installing a probe into the ground, drawing gas out of the probe and collecting it for transport to an instrument that provides a measure of the concentrations of vapors in the sample. Within this broad definition, practitioners have developed a wide range of preferences for methods of installation, probe materials and diameters, purging, field screening, sample containers, and documentation and other details. While any or all of these methods may provide high quality data at some sites, with some sampling teams, they may not be universally applicable, and the potential biases may be impossible to discern or quantify. This concern is not trivial, and is supported by the growing database of soil gas to indoor air attenuation factors (Dawson, 2004), which show a very poor correlation between soil gas data and indoor air data. Even the groundwater to indoor air attenuation factors show better correlation, and considering the added variable of mass transfer from groundwater to soil gas, the correlation for soil gas samples would be expected to be better. Soil gas sampling variability or biases from undiscovered leaks may be a major contributor to the poor correlation between soil gas to indoor air concentrations posted to the database to date, in addition to indoor air quality variability and background contributions in buildings with low VOC concentrations.

It may be instructive to consider an analogy to the evolution of groundwater sampling over time. Prior to 1980, groundwater sampling was primarily conducted for anions, cations, salinity, and other major components at concentrations in the mg/L or higher range. At this level, it was

acceptable to have wells constructed of sorptive plastic, with glued couplings and saw-cut slots, which were sampled using copper bailers, with lead-soldered end-caps, cleaned with acid until shiny and casually rinsed in the field by a technician with minimal training. As data quality objectives changed to require extensive lists of analytes with target concentrations in the  $\mu\text{g/L}$  range, the groundwater sampling protocols grew more refined, and in most cases prescriptive. At the present time, we have protocols such as the “Low-Flow Sampling Protocol” (Puls and Barcelona, 1996), which specifies a pumping rate and drawdown that must not be exceeded, and requires real-time field screening of several water quality parameters to assure consistency before a sample is collected for analysis. By analogy, there is no reason soil gas sampling cannot be done using essentially identical methods.

Until such time that soil gas sampling protocols mature to the level of groundwater protocols, it would be a significant improvement if at least one set of rigorous protocols were available to maximize the likelihood of collecting representative, reproducible, and reliable soil gas samples, under a wide range of site-specific conditions, which can be understood and implemented readily and consistently by field teams at all levels of experience. This is the goal of the protocols provided in the appendices to this document. The rationale behind some of the selections in the protocols is described in the following subsections. The recommended methods for soil gas probe installation are in Appendix D, and recommended methods for soil gas sample collection are in Appendix E.

### **6.1.1 Driven vs Drilled Probes**

Many soil gas samples are collected from depths shallow enough to be reached by direct push techniques, including GeoProbe™, slam-bar, etc. If the soil gas permeability is high, soil gas will flow easily into the probe when a vacuum is drawn at ground surface, and the risk of atmospheric air leakage is minimal, especially for probes greater than about 5 or 10 feet deep. For lower permeability materials and shallower probes, the risk of atmospheric air leaking down the annulus between the drive-rods and the geologic materials may be sufficient to cause a negative bias in the soil gas data, especially if a high level of vacuum is applied during sampling. Seals applied only at the ground surface do not prevent mixing of soil gas from different vertical intervals below ground surface. Therefore, it is preferable to have a reliable seal in the annulus between the probe and the borehole wall throughout the interval from just above the tip or screen to ground surface.

A driven probe can be properly sealed, providing the drive-casing has an inside diameter at least double that of the probe itself, to allow space for adding seal materials. If a core is retrieved from an inner sleeve, there will be less compaction of soils around the exterior of the drive casing, and soil samples can be visually inspected and sampled for laboratory analysis of texture and moisture content, which is valuable and inexpensive information. The hole may stand open when the drive casing is removed, but it is generally better to set the probe, and filter-pack as the rods are withdrawn to avoid potential collapse of the hole, especially in cohesionless soils.

Drilling may be accomplished using solid or hollow-stem augers, hand-augers, core-barrels, split-spoon samplers, jackhammers, or any one of a number of methods that is capable of advancing a hole of sufficient diameter to the target depth within a reasonable period of time and

expense. Conventional practices for groundwater monitoring well drilling are well documented and will not be repeated here.

It may be advantageous to collect basic soil property data from one or more locations (depending on the size of the site and consistency of the geologic materials) to aid with understanding vapor fate and transport mechanisms. Soil samples should be collected from representative stratigraphic layers. Analyses may include:

Soil Bulk Density: ASTM D2937.

Soil Moisture Content: ASTM D2216.

Fraction Organic Carbon: Walkley-Black method (Nelson and Sommers, 1992).

Grain Size: ASTM D422.

One possible drilling option that is unique to soil gas probe installation bears mentioning, which is the challenge of installing soil gas probes in bedrock, or materials that cannot be drilled using augers. Rotary drilling with a tricone or core-barrel may be the preferred option in this case, but of the three most common drilling fluids (air, water and mud), two (water and mud) will either cause a filter-cake on the borehole wall that may be permanent or dramatically change the moisture profile in the vicinity of the borehole wall, neither of which is conducive to subsequent collection of representative samples. Air may be used as a drilling fluid without significant risk of developing a filter-cake on the borehole wall or affecting the moisture content around the borehole, but some of the air used in drilling will flow out into the geologic materials surrounding the borehole, which will cause a high level of disturbance to the local equilibrium, and may take several weeks or months to recover. Helium (or other tracers) can be added to the drilling air by releasing a regulated amount into a shroud constructed around the intake to the air-compressor, and monitoring the exhaust from the drill tip using a field meter. If the concentration of He in the drilling air is maintained at 1% or higher, air can be purged from the probe after installation until He is no longer detectable (<0.01% for most field meters), assuring that the remaining soil gas is 99% or more free of drilling air. Re-equilibration is advisable to allow vertical concentration gradients to return to equilibrium conditions, but the equilibration time will be shorter if the air introduced during drilling is removed.

Regardless of the method of installation, it is usually preferable to allow the seals to set overnight before development and pneumatic testing. It is also advisable to allow conditions to re-equilibrate for some period of time before sample collection. The period of time required for re-equilibration will depend on the amount of disturbance during installation, so it is difficult to specify. In some cases, careful probe installation may not disturb conditions appreciably, and sampling can proceed immediately, but it is generally better to allow a day or more between probe installation and sampling wherever practical.

### **6.1.2 Soil Gas Probe Diameter**

Soil gas samples can be collected from tubing as thin as a millimeter, or from pipe up to several inches in diameter. The scale of the monitoring equipment may need to be modified to the scale of the system being monitored. If a building has a LNAPL beneath it and the water table depth is 10 feet, it may be necessary to collect a vertical profile of soil gas concentrations using very

discrete-depth samples, in which case, a small diameter tubing is helpful, because it minimizes the volume of soil gas that must be purged before a representative sample can be collected.

However, smaller diameter tubing is not necessarily better in all circumstances. It is often also useful to measure flow and vacuum during purging of the soil gas probes, at a minimum to confirm that the probe is not plugged, but more generally because such data can be used to calculate soil gas permeability (Johnson et al, 1991), much as a hydrogeologist will commonly conduct slug-tests to help with characterizing chemical flow and transport. Small diameter probes restrict air-flow and the majority of vacuum in such a test may be attributable to line losses, which would bias any permeability calculations.

Furthermore, the volume of soil gas purged prior to sampling may be controlled by the volume of gas utilized for field screening, rather than the probe diameter. A 1L Tedlar™ bag will generally provide sufficient gas for field screening with a PID or FID and a Landfill gas meter (O<sub>2</sub>, CO<sub>2</sub> and methane), and may also be sufficient for a reading with a helium meter if helium is being used as a tracer to assure against leaks in the sampling train and/or probe seal. If three successive readings are sufficient to assure a reproducible sample, then a total purge volume of at least 3 L will be common. The EPA recommends purging 5 L prior to sampling sub-slab soil gas probes.

Field screening readings typically stabilize after removal of between 3 to 5 casing volumes. If the volume of gas to be removed is 3 to 5 litres, then a probe volume of 1L or less will not impose unnecessarily large purge volume requirements. If the probe is constructed of nominal 1/8<sup>th</sup>-inch diameter tubing (inside diameter actually closer to 1/10<sup>th</sup> inch), a probe volume of 1L corresponds to a probe 126 meters long. A nominal 1/4-inch diameter probe with a probe volume 1L could be 30 meters long. Neither of these is sensible, because probes of that depth could be purged of much more than 5 L without drawing soil gas from an unacceptably far distance. A nominal 1-inch diameter probe could be 2 m in length, which is a much more common depth interval for soil gas sampling. Line losses for a 1-inch diameter probe will not be significant for flow rates of up to about 10 L/min, which is more than ample for assessing pneumatic conductivity for most commonly occurring soil types. Therefore, a 1-inch diameter probe will often be preferable to smaller diameter probes because it can provide both pneumatic and concentration data. If the gas permeability is low, smaller diameter (<1-inch) probes can be used for pneumatic testing without unacceptable line losses, but unless the gas permeability is known in advance, it may be better to install probes of at least 1-inch diameter.

For deeper installations (e.g. 10m), a larger total purge volume (e.g. 20 liters) will not generally be excessive or create bias in characterizations of vertical concentration profiles, in which case the probe diameter could increase to 2-inches, similar to typical groundwater monitoring well design, which may simplify soil gas probe procurement and installation for field technicians trained in hydrogeology. Larger diameter probes can also be more easily converted for use in mitigation systems (e.g. soil vacuum extraction).

### **6.1.3 Soil Gas Probe Materials**

Inert materials should be used for soil gas probe construction, which may include stainless steel, copper, brass, polyvinyl chloride (PVC), nylon, high-density polyethylene (HDPE). Low density

polyethylene, neoprene, rubber, Tygon, and generally any highly flexible tubing should be avoided and should especially not be re-used, because there is a significant risk of carry-over or cross-contamination from sorption/desorption reactions. Couplings should be compression-fittings, or threaded and wrapped with Teflon tape. The top of every soil gas probe should be fitted with a valve that can be sealed air-tight and secured, otherwise barometric pumping will result in depletion of concentrations in the vicinity of the soil gas probe tip. A protective casing or tamper-proof completion is recommended for all soil gas probes.

#### **6.1.4 Use of Water Table Monitoring Wells as Soil Gas Probes**

It is often conventional practice for hydrogeologists to install water table monitoring wells with screened intervals that extend both above and below the static water level, to allow for water table fluctuations and maintain a water table within the screened interval. A vacuum applied to wells of this nature will yield soil gas from the screened interval above the water level in the well, and can therefore be an inexpensive alternative to deep soil gas probe installation.

Soil gas sampling in this situation must be conducted at a vacuum that does not cause upconing of the water level within the well to a height above the top of the well screen, or soil gas flow will cease. The height of screen above the water table should be calculated, and the vacuum applied during purging should be measured to confirm that the vacuum (in inches of water column) does not exceed the available unsaturated screen height. It may also be necessary to monitor the flow-rate, because it is possible for soil gas flow to be cut off when the capillary fringe (or tension saturated zone) rises above the top of the screen.

Off-gassing of vapors from the standing water column within the lower part of the well screen will be negligible, providing several casing volumes of soil gas are purged prior to sample collection, and the purging and sampling procedure is done expeditiously (i.e. over a period of less than an hour). Headspace sampling of the standing air in the well casing that accumulates between sampling events has been used as a qualitative screening of the potential for off-gassing, but should not be considered reliable compared to samples that have been collected after proper purging (minimum of 3 to 5 casing volumes and until field screening readings stabilize).

Soil gas data collected from the unsaturated screen of water table monitoring wells is ideal for assessing whether a fresh-water lens is present, because it provides soil gas samples from immediately above the water table. Groundwater samples from the same wells at the same time will provide data that is uniquely valuable for defining any mass transfer limitations from groundwater to soil gas. An example diagram of the well design is shown in Figure 6-1, which includes two boreholes for a nested vertical profile, but enables collection of shallow groundwater, deep soil gas and intermediate soil gas samples. This can be used to assess the degree of off-gassing of vapors from the water table, as well as the vertical profile of VOCs/SVOCs and O<sub>2</sub>/CO<sub>2</sub>, all of which can be very useful for assessing soil vapor transport and fate mechanisms.

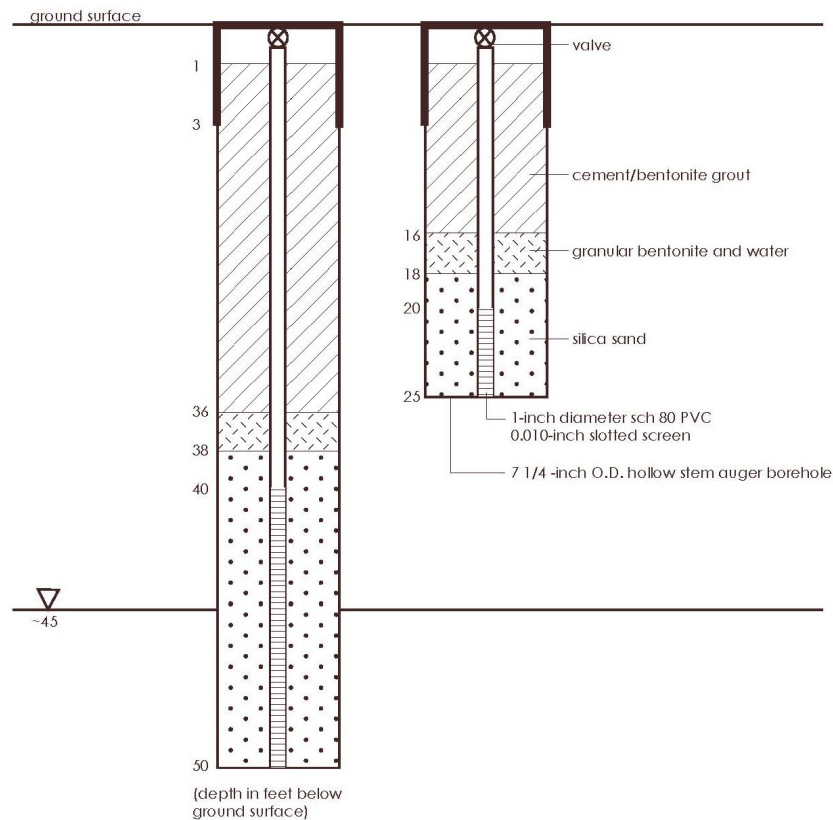

**Figure 6-1**  
**Example Construction Details for Groundwater and Soil Gas Sampling**

### 6.1.5 Screen Length

Soil gas probe screens or intakes should be small enough to provide reasonable resolution regarding the origin of the soil gas samples drawn from the probe. If the unsaturated zone is 10 meters thick, a screened interval of 1 meter may provide adequate resolution; however, if the vadoze zone is only 1 m thick, screened intervals of 0.1 meter may be more appropriate. Screened intervals smaller than 0.1 meter will not necessarily provide any additional resolution, because the purging of a few liters of soil gas for field screening prior to sample collection will draw a sample that is typically from a sphere of radius 10 cm or so from the probe tip.

### 6.1.6 Options for Vertical Profiling

Vertical profiles can be measured using probes installed in separate holes (nested probes), or at several levels within the same probe (multi-level probes). In both cases, it is critical to seal the probe tip or screen at the interval of interest. Bentonite is the most common material for making a seal, but bentonite is sold in chips, pellets, granular and powder form, and the method of placement and the seal effectiveness will vary considerably depending on the form of bentonite used. In general, the most practical and effective method for making seals is to use granular

bentonite (granules that are approximately 1 mm across, or roughly the size of a coarse sand), because it can be easily poured down a borehole, yet it hydrates nearly instantaneously when water is added, and swells very quickly. The seal should be constructed and hydrated in lifts to ensure that all bentonite is properly hydrated.

Powdered bentonite can also be used, but it is preferable to mix it with water in a container above ground until thick and viscous (like a milkshake) before pouring down a borehole. Ideally, the tip of a probe will be surrounded with a sand filter pack, and a bridge of granular bentonite will be placed above the filter pack, and hydrated with water from above. Thereafter, the remainder of the annulus can be filled with a slurry of powdered bentonite and water.

When installing multi-level probes, it may be possible to add granular bentonite and water alternatively to seal the interval between filter packs (if the sealed interval is a few feet or less), or have a bridge of hydrated granular bentonite at the top and bottom of the seal, and a slurry of bentonite and water in between the two bridges (in which case, it is advisable to add bentonite chips or pellets to the slurry to ensure the upper bridge does not collapse. A tamping rod may be useful to mix the water and granular bentonite down-hole, and to confirm that the seals have been set to the planned depth intervals.

### **6.1.7 Probe Development**

Disturbance during soil gas probe installation may affect the representativeness of any samples drawn soon after the installation process. This may be managed either by developing the probe (purging until atmospheric air introduced during the installation process has been removed) or waiting sufficient time for conditions to re-equilibrate prior to initial sampling, or both. Purging of up to 10 probe volumes after seals have set, with monitoring of flow rates and vacuums for pneumatic testing, and field screening to confirm the attainment of steady readings is a reasonable approach to probe development.

Allowing time for seals to set and time for re-equilibration between development and initial sampling is advisable whenever practical. Where impractical, the sampling record should document the time between installation and sampling. If future monitoring data are not consistent, this information will be useful for qualifying any initial data that may later be shown to be anomalous.

### **6.1.8 Leak Testing**

Leak testing is generally good practice, and should be performed at least once at each probe to test the seals preventing short-circuiting of atmospheric air into soil gas probes, and at least once on the apparatus used for collecting a sample. The two tests are conducted differently.

The annular seal is best tested by constructing a shroud around the ground surface at the top of the probe and filling it with a tracer gas (e.g. He). A tube is connected through the shroud to the top of the soil gas probe and a pump, and the pump is used to draw soil gas into a Tedlar™ bag, which is then screened for the concentration of He. Portable helium meters are capable of reading from 100% to 0.01% He, so they provide ample resolution of any leak of atmospheric air

that may be occurring. For example, if the shroud contains 10% He and the sample contains <0.01% He, then the sample must be >99.9% representative of subsurface gas. If there is less than about 10% leakage, it may be acceptable to use a mass balance approach to correct the soil gas sample data. However, if there is more than about 10% leakage, the probe should probably be replaced.

Leaks in the sampling train can be tested in two practical ways. In the first method, the pump used to draw a vacuum would simply be reversed to create positive pressure, and a soapy water solution is poured on connections where a leak might occur. Soap bubbles will form if air is leaking. In the second method, a Tedlar™ bag is filled with a known concentration of a gas (e.g. use the span-gas for the PID or FID being used for monitoring the progress of purging), and a valve is connected to its opening, and closed until the vacuum in the sampling train roughly matches the vacuum encountered when drawing soil gas from a probe. If a sample collected from this apparatus has the same concentration as the source gas, this would indicate the absence of leaks. Otherwise, the apparatus should be repaired to prevent leaks.

### **6.1.9 Purging and Sampling**

Standing air inside the probe must be purged prior to sampling at a minimum, because it is subject to changes through sorption to the probe tubing, condensation, or other processes over time. Additional purging to provide sufficient volume for field screening to confirm steady readings prior to collection of a sample for laboratory analysis is also highly recommended, provided the volume does not cause undue bias by mixing soil gas from disparate locations or depths. The field screening samples should be collected in a dedicated Tedlar™ bag using a lung-box or vacuum chamber. Details of lung-box operations are provided in the suggested operating procedures in Appendices F and G. Tedlar™ bags filled from the exhaust of a pump may incur a bias from carry-over between samples. New, disposable, and inert tubing (HPDE, nylon, stainless steel, etc.) should be used between the soil gas probe and the Tedlar™ bag.

Field instruments should not be connected directly to a soil gas probe for two reasons: 1) their pumps may draw soil or water into the instrument, which is potentially damaging, and 2) the flow rate will diminish in inverse proportion to the soil gas permeability, which will affect the instrument calibration. All calibrations and reading should be made from Tedlar™ bags at ambient temperature and pressure. Field instruments should be calibrated on-site where practical, and the calibration should be checked and recorded regularly, with re-calibration whenever there is significant instrument drift. Drift limits are specific to each instrument and chemical(s) of concern, however, they should be considered and specified in advance of field sampling activities.

Upon confirmation of steady readings in a few successive Tedlar™ bag samples, the sample may be collected for laboratory analysis, using one of three approaches:

1. Fill an additional Tedlar™ bag and draw the contents directly into a Summa™ canister (1-L Summa™ canister with 1-L Tedlar™ bag, or 6-L Summa™ canister with 5-L Tedlar™ bag). This approach has many benefits: it provides a visual confirmation that the Summa™ canister is drawing a sample because the Tedlar™ bag will deflate as the Summa™ valve is opened; it provides an opportunity to field screen the exact same gas that was shipped to the



laboratory to confirm consistently with readings during purging, and; it provides a sample container that will prevent degradation of the sample for holding times of two weeks or more.

2. Connect a Summa™ canister directly to the soil gas probe valve, and draw a sample directly into the Summa™ canister. This approach has an inherent risk of sucking porewater into the Summa™ canister, although it should be possible to assess the likelihood of this during the purging and pneumatic testing procedures.
3. Connect a “T” fitting to the soil gas probe, purge from one end and connect the Summa™ canister to the other end. This will collect a side-stream sample, and will avoid drawing water into the sample. This approach can also be used to collect an integrated average sample of a larger purge volume, depending on the flow rates from the purging pump and the Summa™ canister and the duration of the sampling event.

Samples can be shipped in Tedlar™ bags, but their holding time is much shorter (<48 hours), and if shipped by air, they can burst at altitude if overfilled.

Samples can be collected using automatic thermal desorption tubes (ATD tubes) for analysis by EPA method TO-17, but the sorptive media could be either under-loaded or overloaded if there is no advance knowledge about the concentrations and constituents present. An overloaded ATD tube will result in breakthrough, with loss of mass and an underestimation of concentration. An underloaded tube will have a higher detection limit. Additionally, soil moisture may compete for adsorptive sites, and complicate the sampling process, particularly in cold weather, when condensation within the tube could be exacerbated.

Glass syringes are useful for sampling when a mobile laboratory is available, but they are not conducive to shipment to a remote location.

All of these alternatives were considered prior to development of the protocols presented in Appendix E, but the recommended approach was ultimately selected because it will be most widely applicable, robust, reliable, easily implementable, and easily documented.

## **6.2 Sub-Slab Sampling**

Sub-slab sampling is intended to draw gas from the air-space immediately below a floor slab, either within the pore-space of the granular fill that is typically placed below a poured concrete slab, or within an air-gap that will occasionally form beneath the concrete in response to differential settlement over time. The floor can either be drilled or cored to provide access, and an insert is typically installed and sealed into the floor. Care must be taken to ensure that post-tension concrete wires/cables are avoided to maintain structural integrity. The probe will usually have a threaded cap or valve that will allow the insert to remain sealed between sampling events and opened during sampling events.

It is critical that the insert be sealed effectively to prevent leaks of air from inside of the building to the sub-slab air-space. A bead of sealant around the top of the probe is not sufficient, the seal must extend at least a few inches below the floor. It is also not sufficient to drill a hole of similar

diameter to the outside diameter of the insert, and assume that the friction between the two surfaces will provide a sufficient seal.

EPA has prepared draft guidance for the installation of sub-slab inserts (EPA, 2004) which calls for a pilot hole to be drilled with a similar diameter to the insert through the floor, then the upper few inches to be reamed to a larger diameter. This allows the probe to be inserted with a snug fit through the lower half of the hole, and a seal to be placed around the upper half, with sufficient annulus in the upper portion to ensure that the sealant is evenly distributed and provides an effective seal, as shown in Figure 6-2, below.

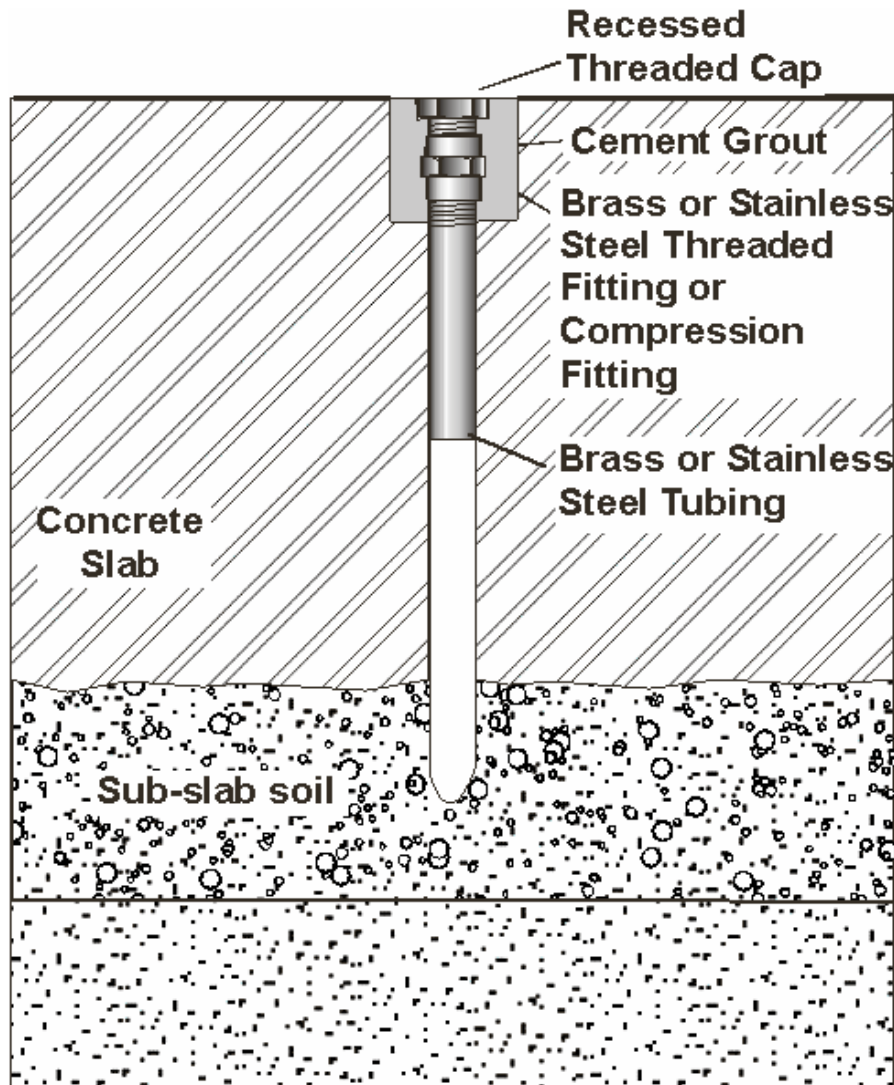

**Figure 6-2**  
**Recommended Design for Sub-Slab Soil Gas Probes (EPA, 2004)**

Various sealants are possible, and there may be a need to assess their respective performance: bentonite and water forms a good seal if mixed to the appropriate consistency, but may dehydrate over time, and lose its effectiveness. Cement is typically porous, and may not form a good seal. Expanding cement (cement specifically designed to be used to seal wet cracks in basement walls

and floors) may form a better seal, but the issue of porosity has not been tested. Some hot glue sticks are comprised of polyethylene, which is non-porous and relatively non-sorptive, and because the glue flows easily when hot, it is likely to distribute evenly and effectively within the annulus, and will not dehydrate over time. Urethane and silicone form good seals but may contribute VOC vapors to the sample.

The recommended field methods for sub-slab probe installation and sampling are presented in Appendix F.

### **6.3 Groundwater Sampling**

Groundwater sampling may or may not be necessary or appropriate, depending on the site conditions. If transport through groundwater is a significant mechanism, or if a fresh water lens is known or suspected to be present, groundwater sampling may be a valuable supporting line of evidence. However, groundwater data is not necessarily needed if soil gas data are sufficient to delineate the area of possible concern for vapor intrusion, regardless of whether the source is above or below the water table. The need for groundwater sampling and analysis must be assessed on a case-by-case basis.

A key consideration for groundwater sampling in a site-specific assessment of vapor intrusion is the position of the sample relative to the water table, and the length of the screened interval over which the sample was collected. If this information is not otherwise available, groundwater data should either be collected using depth-discrete sampling protocols, or should be supported by deep soil gas data, or both.

For vapor intrusion assessments, the preferred groundwater sampling methods (if needed) are those specifically designed for discrete-interval sampling from temporary borings, such as:

- Limited Access Direct-Push Techniques, including: GeoProbe™, Power Punch™, Strataprobe™, and Precision Sampling™
- Cone Penetrometer
- Simulprobe™
- Hydropunch™
- Waterloo Profiler™
- Westbay System™
- Diffusion Multi-Layer Sampler
- Continuous Multi-Channel Tubing™
- Point Sampler or Dual Packer Sampling

Summaries of these techniques are presented in a recent EPA report (EPA, 1999), available online at <http://www.epa.gov/tio/download/misc/mgp/>. One significant concern that is common to many temporary and depth-discrete groundwater sampling methods is turbidity, especially in fine-textured geologic materials. Where turbidity is elevated (>10 NTU), the concentrations of

chemicals may be positively biased. One approach for assessing this is to have two sets of groundwater samples collected, and have one set analyzed normally, and the other set centrifuged in the laboratory with analysis only of the supernatant liquid. Comparison of the two results should clarify whether and to what extent the turbidity affects the measured concentrations.

There are some commercially available techniques for obtaining depth-discrete groundwater samples from existing monitoring wells. For example, screened intervals can be isolated using packers and the isolated interval pumped using low flow techniques. Also, the Hydra-Sleeve® sampler can be used to collect samples at multiple depths within an existing long screen well. The results from these techniques can become complicated to interpret if there is vertical flow or mixing within the well screen or filter-pack, thus obscuring the actual concentration profile.

US EPA has experimented with depth-discrete groundwater using passive diffusive samplers separated by gaskets, in order to characterize the vertical profile of VOCs (Paul et.al, 2003). This degree of discretization may not be practical at many vapor intrusion assessments, particularly at a screening assessment level.

## **6.4 Indoor Air Sampling**

Indoor air sampling conducted for site-specific assessments of subsurface vapor intrusion will typically detect up to a few dozen compounds that originated from consumer products, building materials or outdoor air, some of which may be present at concentrations above target indoor air concentrations, and some of which may be identical chemicals to those present in the subsurface, regardless of whether the contribution of subsurface vapors is significant or not. Therefore, it is important to carefully plan strategies for limiting sampling to chemicals of concern (COCs) and resolving the relative contribution of subsurface vapors from interior (background) or exterior (ambient) sources.

Wherever possible, a pre-sampling survey should be conducted at least 24 hours in advance of any indoor air sampling. It is advisable to remove consumer products that contain VOCs or SVOCs from the building and any attached garage or shed at least 24 hours prior to sampling to the extent possible. Any unavoidable exceptions should be documented and reported conspicuously with the results of indoor air sample analysis. Compounds present in various consumer products are described in the household products database (<http://householdproducts.nlm.nih.gov/>), which may assist in interpreting indoor air quality data.

Indoor air quality varies with wind-speed, occupant's habits (opening and closing doors and windows, use of consumer products containing volatile and semi-volatile chemicals), and barometric pressure trends. Indoor air quality target levels are typically calculated for a 30 year exposure scenario, therefore, short-term fluctuations are insignificant, and long-term average concentrations are the most appropriate for risk assessment. Summa™ canisters are typically supplied with flow controllers designed for 8 or 24 hour integrated sample collection, but it is possible to get 7-day flow controllers and these may provide more representative samples. ATD tubes are typically designed for sampling over 8 or 24 hour periods, but can be designed to allow sampling over longer periods by either reducing the flow rate, or increasing the mass of adsorbent material and using a larger tube (i.e. VOST tubes). Personal sampling pump batteries

are not designed to last for 7 days, but with an AC adapter, long-term average samples are possible. Experience from radon monitoring a few decades ago demonstrated that short-term grab samples provided a much higher degree of variability than longer-term average samples, and the US EPA currently requires a minimum of 48 hour sample collection events, with many sampling methods for radon designed to provide integrated average concentrations over several weeks or months (US EPA, 1992d). To date, the authors are not aware of any convincing studies that demonstrate seasonal trends in subsurface vapor intrusion that can be discerned from diurnal effects.

A comprehensive guide to planning and execution of indoor air quality surveys has been developed by the Massachusetts Department of Environmental Protection (MADEP, 2002), which is the most comprehensive treatise on the subject to date. A detailed discussion of the use of Summa™ canisters and Tedlar™ bags has been prepared by Air Toxics Ltd of Folsom, CA, and is included with permission in Appendix G. It covers topics such as planning, techniques, sources of indoor air vapors, sampling conditions, durations, frequency, locations, numbers and media, analytical methods, quality assurance, data evaluation, and health risk assessment. They recommend an approach that includes the following steps:

1. Define Study Objective
2. Identify Chemicals of Concern
3. Identify Required Sampling Duration & Frequency
4. Choose Sampling Method
5. Check if Detection Limit is Adequate
6. Define QA/QC Indicators for Sampling/Analysis
7. Conduct Pre-Sampling Investigation
8. Establish Appropriate Sampling Conditions and Conduct Sampling
9. Analyze Samples and perform Data Quality Assessment
10. Evaluate Data and Calculate Health Risks

MADEP recommends sampling groundwater and soil gas prior to indoor air monitoring and using these data to select the compounds of potential concern in indoor air, noting that the indoor air concentration is seldom more than 5% of the soil gas concentration (EPA, 1992a).

A Recommended Standard Operating Procedure (SOP) for the Collection of Air Samples is included in Appendix 4 of the MADEP guidance, which is available for download from <http://www.mass.gov/dep/ors/files/indair.pdf>.

Soil gas entry into a building will tend to increase when barometric pressure is falling and decrease (or even cease) when barometric pressure is rising. Indoor air samples may therefore either underestimate or overestimate long-term average conditions relevant for risk assessment, unless barometric pressure is essentially constant during the sampling duration, or the duration is long enough to experience roughly equal proportions of increasing and decreasing barometric pressure. Barometric pressure data is available from most airports, but can also be easily

measured with inexpensive equipment (e.g. Barologger™) if a weather station is not near the study area. Until improved methods are available for long-term sample collection, it is advisable to record the barometric pressure and document it with indoor air quality data.

Pressure differentials (indoor to outdoor, or indoor to sub-slab) are much more difficult to measure. Typical diaphragm vacuum gauges are not sensitive enough for the low gradients typically observed (<10 Pa), so micro-manometer technology is required. Fortunately, this is routine in the field of HVAC engineering, and many commercially available products exist, including data logging capabilities. Pressure differentials may be plotted against barometric pressure changes to assess the correlation. It may also be appropriate to monitor the use of kitchen and bathroom exhaust fans, central vacuum cleaners, clothes dryers, window-mounted air-conditioning units, or other mechanical devices that result in net flow of air either into or out of a building during the monitoring interval.

Smoke-sticks can be used to screen any visible cracks in subsurface walls or floors for influx of soil gas. In some cases, it may be worth fitting a fan in a doorway or window and purposefully exhausting air from the building in order to magnify any such effect, and facilitate identification of any preferential pathways around cracks, sumps or utility entrances/exits. In some cases, field screening with an FID or PID (particularly the more sensitive devices, such as the ppBRAE™) may be used in combination with such a strategy to rapidly identify potential points of soil gas entry into buildings.

## **6.5 Outdoor Air Sampling**

Indoor air consists of >95% outdoor air, and in many cases, outdoor air contains a number of vapors at detectable concentrations, some of which may be above risk-based target concentrations. Therefore, it is often prudent to collect outdoor air quality data when indoor air quality data is being collected. If outdoor air sampling is conducted, a minimum of one sample for every day of sampling should be collected, and more may be appropriate if the indoor air quality assessment area is large. In urban areas, outdoor air is more likely to contribute unacceptable concentrations to indoor air, in which case it may be appropriate to collect an outdoor air sample prior to indoor air monitoring, for example, during preliminary soil gas survey phases, in order to provide advance warning of potential compounds that could be expected to pose an interpretive challenge. If such a condition exists, it may be valuable to communicate with regulators prior to the indoor air monitoring, and preferably establish a policy regarding such a condition in advance.

The outdoor air quality data will identify vapors from automotive fuels and exhaust, point sources (gasoline stations, stack emissions, etc.), and possibly unique situations (paving crews, forest fires, etc.). It will not identify background contributions from consumer products and building materials within a building, which may be so variable from building to building or time to time as to be difficult to discern uniquely.

It is important to protect outdoor air samplers from the elements (wind, rain, snow, ice) and vandalism. The locations should also avoid tarred rooftops on hot days, trees that may uptake VOCs from groundwater through their roots and transpire them to the atmosphere, and emissions

from soil vacuum extraction or groundwater treatment systems, which often have permitted discharge limits considerably higher than target risk-based inhalation concentrations.

Ambient air quality has been studied for decades, including the Total Exposure and Assessment Methodology (TEAM) studies, the National Human Exposure Assessment Survey (NHEXAS) studies, the National Air Toxics Assessment (NATA), and several international studies. In many cases, outdoor air quality in urban environments exceeds health-based target concentrations. Factors affecting outdoor air quality have changed significantly over the past few decades over which these studies have been conducted, so the data should be reviewed to evaluate its applicability to current site-specific vapor intrusion assessments.

## **6.6 Meteorological Monitoring**

Meteorological data may be important as a line of evidence for assessing vapor intrusion, and site-characterization data. Weather stations are available via the internet, so the data collection is usually simple, and does not require specialized equipment, although digital barometers and temperature loggers are inexpensive and may be justified in some cases. In general, the following information should be recorded at least daily during field sampling events:

- Wind speed and direction,
- Temperature,
- Barometric pressure (continuous data preferred), and
- Rainfall (including 24 hours prior to sampling events)





# 7

## DATA ANALYSIS AND INTERPRETATION

---

Proper data analysis, reduction, and interpretation can be challenging, and no single approach will be universally applicable to all site conditions. This chapter describes a variety of approaches, consistent with the philosophy of multiple lines of evidence, which should be considered within the context of the site conceptual model. In some cases, available data are not sufficient to support one or more of these methods of interpretation, so the user must carefully consider which of these approaches are most suitable for a particular site.

Simple comparison of measured indoor air quality to risk-based target concentrations will often result in a false positive determination of chemicals attributable to background sources. An example of such a compound is benzene, which has a risk-based target indoor air concentration at the 10E-6 incremental cancer risk range of 0.31  $\mu\text{g}/\text{m}^3$  (draft OSWER Guidance, Table 2c), which is less than typical background outdoor air concentrations in many urban environments, due to ubiquitous automotive emissions (see for example the NATA model results at <http://www.epa.gov/ttn/atw/nata/mapconc.html>). This challenge is recognized in some jurisdictions, such as Massachusetts, where indoor air quality targets are the higher of risk-based levels or published background. It is also the motivation behind several background air quality studies that are currently being conducted, but are not yet published. Elucidating background contributions from subsurface vapor intrusion is inevitably challenging, and is the goal of the various interpretive techniques described in this section.

### 7.1 Data Organization and Review

#### 7.1.1 Data Organization

To begin the data analysis, relevant information collected should be organized to facilitate the evaluation process. Suggested data organizational steps include:

- Re-evaluate and update the site conceptual model;
- Identify chemicals of concern for site and rank them in order of relative risk (concentrations divided by target concentrations);
- Tabulate all relevant groundwater, soil gas (soil matrix and sub-slab), and air (indoor and outdoor) quality data;
- Identify air background concentrations (typical or site-specific) for chemicals of concern;
- Identify target concentrations (indoor, sub-slab, deeper soil gas);

- Prepare plan view maps showing lateral distribution of sampling points and chemical concentrations in all media; and
- Prepare cross sections illustrating vertical distribution of sampling points and chemical concentrations in all media where vertical profile data is available.

### **7.1.2 Data Quality Review**

A review should be conducted to assess potential sources of bias and variability in the data. Data may be qualified or not considered in the evaluation based on analytical laboratory quality assurance / quality control measures, results of the occupant survey conducted prior to indoor air sampling, potential barometric influences on sample collection, departures from standard sample collection protocols, or results of analysis of tracer compounds used during soil vapor sampling. Relevant departures from suggested operating procedures should be described, justified and documented.

Routine data verification and validation should be considered (e.g. EPA, 1996). Field and laboratory blanks should be reviewed for possible chemicals that may be introduced by the sampling equipment or analytical laboratory. Relative percent differences (RPDs) for duplicate samples should be calculated and compared to data quality objectives (Typically RPD <25% for field duplicates).

Occupant survey forms should be processed to develop a list of chemicals used stored or handled in each building. In many cases, the survey will identify a product by a brand name, and not necessarily the constituent chemicals. The Household Products Database (<http://householdproducts.nlm.nih.gov/>) is helpful for identifying constituents of a specified product, or common uses for specified chemicals. While this does not provide an expected concentration, it can at least be used to identify compounds that might be expected to originate from interior sources.

The barometric pressure trend (rising, falling or neutral), magnitude, and rate of change (typically 0.2 to 2.0 % of atmospheric pressure/day, Parker, 2003) should be considered. Subsurface vapor intrusion rates will tend to increase when barometric pressure is falling, and vice-versa. Similarly, rainfall events within a few days prior or during any soil gas or indoor air sampling event should be clearly identified, including the amount of rain, and whether it was sufficient to create any ponding (saturated surface condition, which would limit natural losses of soil gas to the atmosphere).

The soil gas permeability should be assessed by review of the vacuum and flow rate recorded during purging for probe development, and prior to sampling. If a vacuum of >100 inches of water was required to obtain a sampling flow rate of 1 L/min, the soil gas permeability may be too low to yield a representative sample. If so, an appropriate qualifier should be put on the soil gas data, and other lines of evidence should be given proportionately more weight.

If tracers are used to assess the effectiveness of seals between sub-slab or soil gas probes and the surrounding slab or geologic materials, a calculation of the percentage of tracer gas in the sample should be performed. If the percentage is greater than a few percent, the sub-slab or soil gas data

should be qualified accordingly. It may also be advisable to perform a correction, where the soil vapor concentrations are increased in proportion to the amount of leakage, particularly if the amount of leakage is greater than 10%. If the percentage of leakage is >50%, other lines of evidence should be given proportionately more weight.

Field screening with an FID or PID can be compared with the results of laboratory analysis. If the field instruments yield readings greater than 10 ppmv for a soil gas sample, and the sum of individual analyte concentrations in a TO-15 analysis is dramatically less (say <1 ppmv), there may be a compound or compounds present that was/were not included on the TO-15 analyte list. It may be possible for the laboratory to provide a chromatograph, which may be instructive, either if it shows an elevated baseline, a number of small peaks (as might be observed with hydrocarbon mixtures) or a small number of large peaks, which may be important to identify by mass spectrophotometry, and possibly supplemental sampling for analysis by other methods (TO-17 for SVOCs, TO-3 for hydrocarbons, etc.). FID or PID calibration data should be reviewed to ensure that instrument drift was within acceptable limits.

Groundwater data used for the purpose of assessing vapor intrusion should be reviewed with respect to the thickness of the saturated screened interval, pump intake position during sampling, flow rate and drawdown during purging, and any stratigraphic information on the borehole log that might indicate higher permeability zones within the screened interval, which would be expected to contribute the majority of water flow to the well during sampling. If the flow-rate during purging is sufficient to cause drawdown of a few feet in a monitoring well screened across the water table, this will result in de-watering of the upper part of the filter pack. The hydraulic conductivity of the filter pack and surrounding geologic materials will decrease if dewatering occurs; therefore, water flow into the upper part of the well screen will be inhibited, and the resulting sample will be representative of the deeper intervals, which are less likely to correlate well to deep soil gas concentrations. Similarly, if the pump intake position is near the bottom of the well during purging and sampling, the sample may also be more representative of the deeper groundwater, and less valuable to assessing vapor intrusion.

Calculations should be performed to compare data from different media or different sampling methods. For example, shallow groundwater concentrations can be multiplied by Henry's Constant (for each compound, at site-specific temperatures) and compared to deep soil gas concentrations. If the two are similar (within a factor of 3 or less), the correlation would indicate that deep soil gas and groundwater are essentially in equilibrium. If the deep soil gas concentrations are more than an order of magnitude higher than those that would be calculated from groundwater, it is likely that there is a source in the vadose zone, or that soil vapor transport through the unsaturated zone is more important than lateral transport in groundwater, or that excessive borehole dilution has negatively biased the groundwater quality data. If the soil gas concentrations are more than an order of magnitude lower than that calculated from groundwater, there may be a fresh-water lens that is inhibiting off-gassing or there are attenuation mechanisms, such as biodegradation, affecting the vapor concentrations.

Flux chamber measurements can be compared to the upward diffusive flux that would be calculated from soil gas data using Fick's Law, with an estimate of the effective diffusion coefficient. In each case, the ground surface condition for the flux chamber should be considered (uncovered, covered, or cracked). The relative magnitude of the flux for compounds

with relatively high and relatively low diffusion coefficients should be compared to assess whether the relative measured flux rates follow theoretical trends.

If the data quality review indicates unacceptable bias, consider re-sampling, qualifying the data, or excluding the data from the interpretation and conceptual model. The information collected during site-specific assessments should be evaluated to assess consistency with the site conceptual model, and the model should be updated as appropriate when new information becomes available.

## **7.2 Data Analysis**

Detailed data analysis is conducted to characterize the contribution of subsurface vapor intrusion to indoor air concentrations and assess the contribution due to background sources or other potential data issues.

### **7.2.1 Comparison of Indoor Air to Outdoor Air and Background**

Before comparing indoor air data to target concentrations, a careful review of outdoor air quality and typical background indoor air quality should be performed. This comparison can determine whether the indoor air data are consistent with what might be expected in the absence of subsurface vapor intrusion. Outdoor air quality data for the same date and duration as the indoor air data could potentially be subtracted from the indoor air concentrations to obtain a corrected indoor air concentration representing both contributions from interior and subsurface sources. This may not be valid if the source of chemicals in outdoor air is a localized point-source compared to a spatially distributed source where outdoor air concentrations are more consistent.

The chemical inventory identified during the pre-sampling survey should be used to develop a list of compounds known or suspected to be contained within any consumer products that were not removed from the building at least a day in advance of the indoor air sampling. This list should be tabulated with the indoor air quality data to identify possible correlations. This is not a quantitative analysis, but can be a supplemental line of evidence.

Comparison to background indoor air quality in buildings that are not associated with subsurface vapor intrusion is somewhat more challenging, because of spatial and temporal variability, and limited data. Some of the most frequently cited studies (Shah and Singh, 1988, Stolweijk, et al, 1989) are more than a decade old. Other studies are regional, and may not be applicable elsewhere (TEAM Studies, UK studies, etc, etc.). Current studies of indoor air quality are being conducted (Massachusetts Residential Indoor Air Background Study and New Jersey DEP), but the results have not been made public as of the date of this report. The available data on background indoor air quality are increasing continuously. Therefore, the user should consider potential sources of background indoor air quality information, and consider discussing the applicability of different sources with regulatory agencies, occupants or other stakeholders at early stages of the site-specific assessment process. It may not be possible to perform a simple subtraction for background indoor air quality data, because it may vary considerably from building to building and time to time. Instead, it may be necessary to adopt a statistical approach. Indoor and outdoor air quality data are often populated with non-detect and estimated

(i.e., J-qualified) results, which may require special treatment for statistical reasons (Gilbert, 1987).

### **7.2.2 Consistency in Chemical Concentrations: Subsurface to Indoor**

Most VOC vapors have similar vapor transport properties, so they are expected to migrate at similar rates. However, similar intrusion rates into buildings are not expected if constituents biodegrade at different rates. If subsurface vapor intrusion is occurring and indoor air quality data are not biased by interior or outdoor sources, then a correlated concentration ratio for chemicals of concern should be seen in each media sampled. For example, if Compound A has a concentration 10 times as high as Compound B in the subsurface soil gas, then the same relative proportions are expected in indoor air, providing that neither compound is amenable to biodegradation in the vadose zone.

This approach is a useful technique to assess background sources at sites with sufficient data. For each compound detected in both indoor air and soil gas near or beneath the building, empirical attenuation factors (ratio of indoor air concentration divided by subsurface concentration) may be calculated. If subsurface vapor intrusion is the only contribution to indoor air vapors, all calculated attenuation factors should be similar. If there is a contribution from interior sources, the attenuation factor for one or more compounds will be higher (i.e. 0.01 instead of 0.001). In some cases, the attenuation factor may be close to unity or even greater than 1, indicating that the indoor air and subsurface concentrations are the same and that background sources are the predominant reason for the presence of the VOCs in indoor air. Where multiple samples are available, it is advisable to calculate the average attenuation coefficient, not just minimum or maximum values.

For sites with large numbers of potentially affected buildings, there may be sufficient data to assess whether there is a correlation between empirical attenuation factors and subsurface concentrations. If subsurface vapor intrusion is occurring, and background sources are not interfering, the magnitude of the attenuation factor should be relatively independent of the subsurface concentration. Some variability is to be expected, but a distinct trend is not. If, on the other hand, there is a baseline concentration attributable to background contributions, the indoor air concentration will not continue to drop as the subsurface concentration drops, the result of which will be an attenuation factor that increase as the subsurface concentration decreases, as shown in Figure 7-1. This figure conveys an important point, which is that measured attenuation factors are much less reliable in the range of very low concentrations, where background contributions are more important. This should be considered when comparing measured and modeled attenuation factors. It may also be possible to plot data for several different VOCs, if their subsurface concentrations span an appreciable range and their indoor air concentrations are detectable. Otherwise, other lines of evidence must be used.

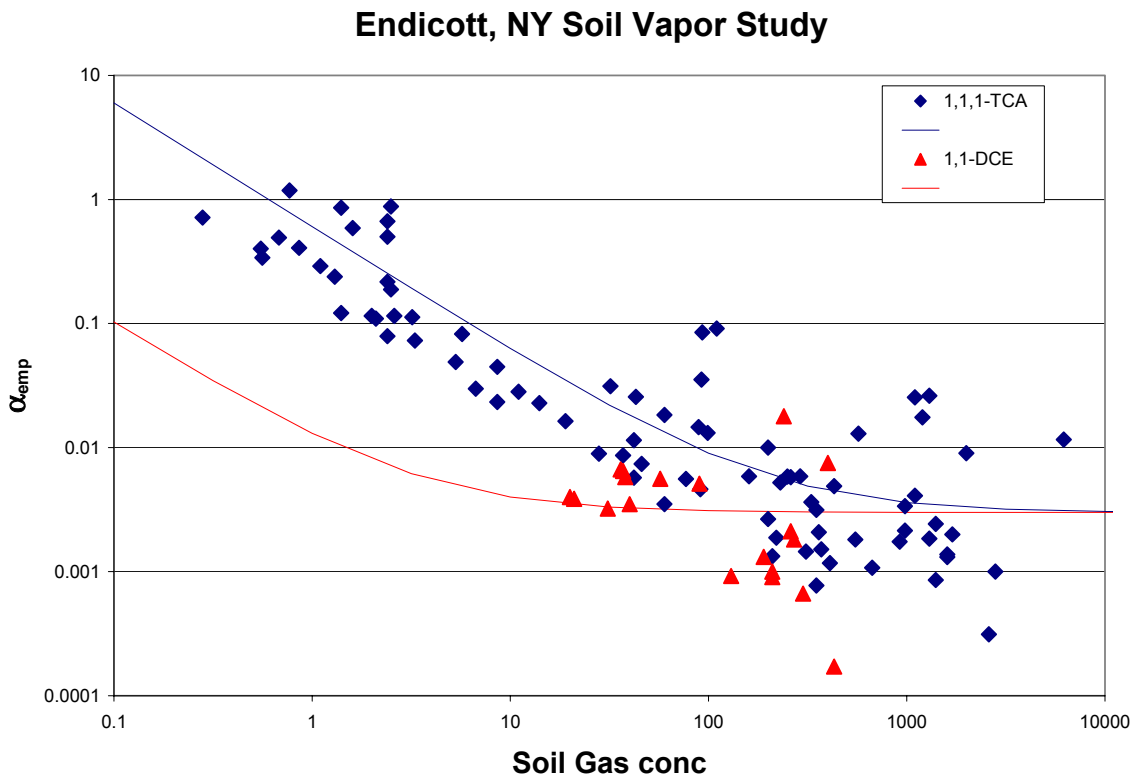

**Figure 7-1**  
**Plot of Attenuation Factor vs Soil Gas Concentration (Ettinger, 2003)**

### 7.2.3 Comparison Between Measurements and Modeling

If site-specific measurements are available, an internal consistency check can be performed by comparing the measured concentrations or attenuation factors to those calculated using a mathematical model to assess whether the two are similar or dissimilar. Several key considerations for use of the J&E Model are important, as described by Johnson (2002). Presuming these have been addressed, the modeled and measured values can be expected to agree within about an order of magnitude, which is often the practical limit imposed by spatial and temporal variability in the site-specific data. If the data are sufficient to calculate spatial and temporally-averaged concentrations or attenuation factors, the agreement between the average measured and modeled values should generally be better than comparisons to individual values (Johnson, et. al., 2002).

In some cases, the measured and modeled results will be dissimilar, even where the model calculations are reasonable and the measurements are representative, reproducible, accurate and precise. This can occur for several reasons, the most likely of which is that there are processes of importance that are not included in the mathematical model, for example:

- a. Preferential pathways (increases intrusion)
- b. Barometric pumping (may increase or decrease, depending on timing of samples)
- c. Aerobic biodegradation (decreases intrusion)
- d. Positively pressurized buildings (decreases intrusion)
- e. Fresh water lens preventing off-gassing from groundwater (decreases intrusion)
- f. Background sources that have not been identified (apparent increase in intrusion)

In some cases, focused investigations of one or more of these processes may provide sufficient information to modify or amend the mathematical model accordingly. Otherwise, it may be acceptable to concede that mathematical modeling is impractical, and rely on empirical lines of evidence.

#### **7.2.4 Use of Specific Chemicals as Tracers**

In some cases, there may be several chemicals detected in subsurface soil gas samples, and one or more of them may be uncommon in consumer products, building materials or outdoor air. In such cases, it may be possible to use such compounds as a tracer to establish the site-specific attenuation factor for subsurface to indoor air. That attenuation factor can then be multiplied by the subsurface concentrations of the other compounds to estimate the concentrations in indoor air attributable to subsurface vapor intrusion. Measured indoor air concentrations in excess of these calculated indoor air concentrations are likely attributable to background sources.

As an example of the use of one compound as a tracer, an extensive investigation was conducted at the former Redfield Rifle Scope site in Colorado (Folkes, et al, 2000), in which 1,1-dichloroethene (11DCE) was detected in groundwater and indoor air over a distance of over 1,000 feet from the source, based on indoor air monitoring in hundreds of homes. 11DCE is formed via hydrolysis of 1,1,1-trichloroethane, but is not common in consumer products or building materials, so background levels are usually below detection limits. The correlation between 11DCE concentrations in groundwater and indoor air was consistent across a range of four orders of magnitude in indoor air concentrations, as shown on Figure 7-2 (Folkes, 2000), subject to variability of plus-or-minus about an order of magnitude.

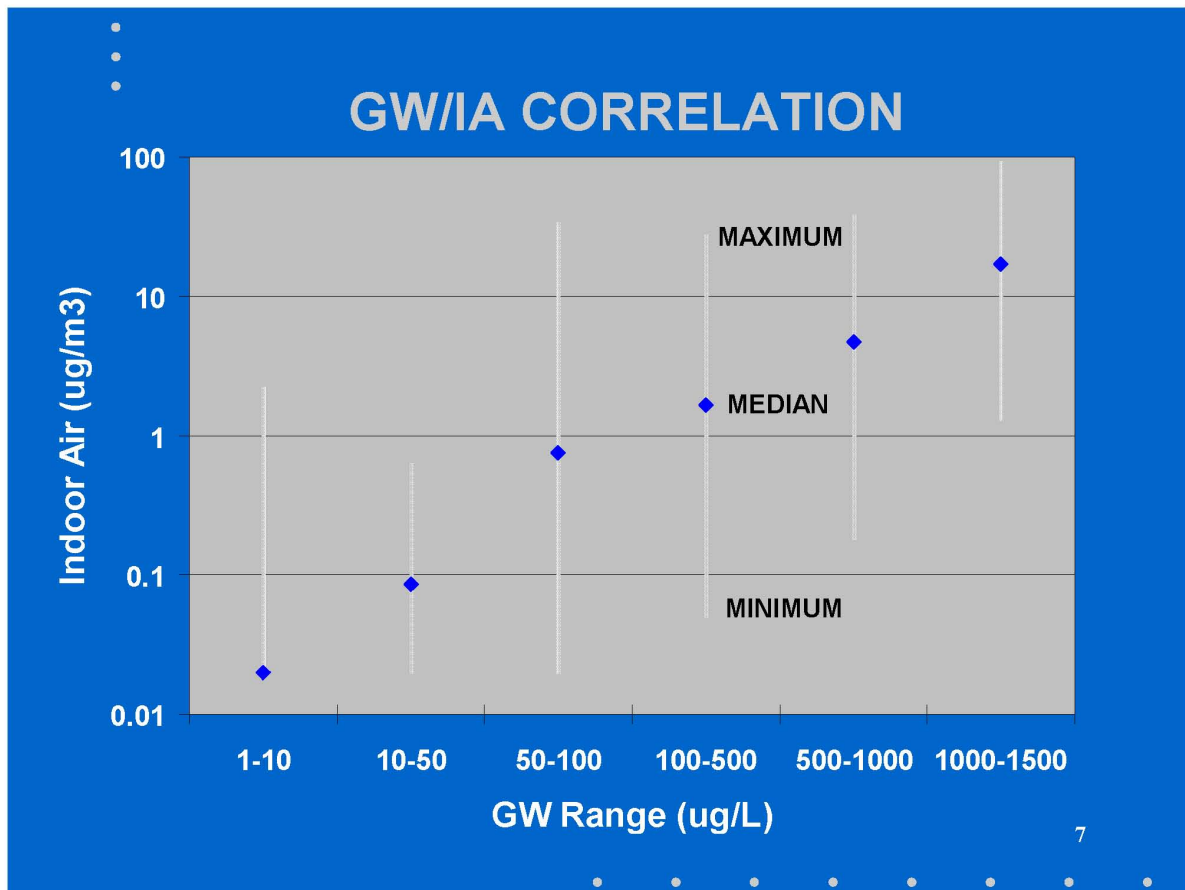

**Figure 7-2**  
**Correlation Between Groundwater and Indoor Air Concentrations for 11DCE (Folkes, 2000)**

MGP Sites will typically have detectable concentrations of a large number of compounds in subsurface gas samples, so there may be several options for site-specific tracers. Potential indicator compounds include indane (a.k.a. indane), indene, thiophene, and possibly others. Some routine methods of sampling and analysis may not quantify the compounds that might be most useful as tracers. Therefore, it may be appropriate to conduct a detailed analysis of source area samples for VOCs via TO-15 with a Summa™ canister, as well as SVOCs via Method TO-1, TO-2, TO-13A or TO-17 with an adsorbent media sampling method, and instruct the laboratory to analyze by Mass Spectrophotometry (MS) and report Tentatively Identified Compounds (TICs), which should maximize the opportunity to identify potential indicator compounds or tracers. Subsequent analyses can then be developed using calibration standards for the potential indicator compounds, so that a defensible quantification can be achieved. This approach will require input from the analytical laboratory, and may require method development or modification, so it may not be appropriate in all cases.



### **7.2.5 Spatial and Temporal Correlations**

Subsurface and indoor air data should be reviewed to assess spatial trends in both data sets, where practical. Plan view maps with concentration contour plots using an order of magnitude as the contour interval would be an appropriate level of detail for groundwater or soil gas data. Indoor air quality data may vary as a function of building design or build quality, and therefore will usually not lend itself to contouring, rather it may be best to plot concentrations via color-coded symbols proportional to multiples of the target indoor air concentration. Areas where indoor air concentrations are higher than expected for the relative subsurface concentration may indicate preferential pathways. Where the converse is true, there may be partial barriers, such as low permeability geologic materials, a fresh water lens, etc.

If available, vertical distribution of soil gas VOC concentrations and biodegradation indicators should also be qualitatively and quantitatively evaluated. The concentrations should be plotted as a function of depth (i.e. vertical profiles) on a cross section and reviewed to evaluate the significance of biodegradation at the site. A reduction in VOC concentration corresponding to an increase in carbon dioxide and depletion in oxygen is indicative of biodegradation. The impact of biodegradation on predicted vapor intrusion attenuation factors should be qualitatively evaluated, and in some case may also be quantitatively assessed. In many cases, there is a biologically active zone, where the majority of degradation occurs, coinciding with sufficient oxygen supply and sufficient hydrocarbon vapor concentrations and moisture to support growth and multiplication of the microbial population. Rapid changes in the slopes of the concentration profiles of O<sub>2</sub>, CO<sub>2</sub> and VOCs are often observed across the biologically active zone.

Some regulatory agencies require consideration of seasonal trends. There have been claims that a frozen ground surface acts as a barrier to natural venting of subsurface vapors to the atmosphere, essentially trapping them in the subsurface. Cold temperatures may also correspond to a maximum stack effect within buildings. Both of these mechanisms would be expected to increase subsurface vapor intrusion, so conditions of frozen ground surface may correspond to a worst-case condition for vapor intrusion, although there is little published data to support this position. In one study with sufficient data (Folkes, 2004), the seasonal variation in indoor air concentrations was minor compared to diurnal variations, or variation attributable to barometric pressure changes. Therefore, seasonal data collection is not recommended in all cases.

Fluctuating water tables may cause fluctuating soil gas concentrations, particularly in the case of LNAPL materials that are smeared across the capillary fringe, with differing amounts of these materials being exposed to the soil air phase with differing water table elevations. Water table elevations can also change seasonally, in some cases by enough to be significant for vapor transport. When the water table rises, soil gas is pushed up like a piston. Water table fluctuations may also contribute to vertical dispersion of subsurface vapors (Parker 2003). In general, water table fluctuations would either have to be very large (tens or hundreds of feet) or very frequent (e.g. tidal effects) to contribute significantly to vapor intrusion.

### **7.2.6 Causal Relationships**

Where data are sufficient to assess cause and effect relationships, they should be analyzed and presented. Examples include plots of indoor air concentrations vs the magnitude of the rate of

change in barometric pressure corresponding to each sampling event for buildings sampled on multiple occasions. In theory, indoor air concentrations should increase with increasing rate of falling barometric pressure, and if trend is not observed,  $Q_{soil}$  may be dominated by other factors (HVAC operations, the stack effect), or indoor air quality may be dominated by background sources. Similarly, if building pressure is increased via HVAC modification or sub-slab vacuum is achieved with a sub-slab venting system, indoor air concentrations should diminish significantly for any compounds whose primary source is subsurface vapor intrusion. Compounds that are not affected by such changes in pressure gradients are likely from interior or ambient (outdoor) sources.

If indoor air samples are collected near sumps or sewers or the perimeter crack, or other areas of suspected entry of vapors from the subsurface, their concentrations would be expected to be higher than indoor air samples from the breathing zone if vapor intrusion is occurring. Indoor air concentrations in upper levels of the building might also be expected to be lower than basement concentrations, depending on whether the air circulation in the building is passive or active.

One compelling causal relationship is a trend in concentrations with highest concentrations at some depth beneath a building, lower concentrations at shallower depth(s), lower concentrations in indoor air, and still lower concentrations in outdoor air. If any of these compartments are out of sequence, or if concentrations in one or more compartment are below laboratory reporting limits, it may be difficult to determine whether vapor intrusion is occurring.

### **7.2.7 Ratios of Two or More Compounds**

Most VOCs of concern for the vapor intrusion pathway have similar physical and chemical properties affecting their mobility. Therefore, compounds present in the subsurface at similar concentrations with similar distributions should also be detected in indoor air at similar concentrations, if vapor intrusion is occurring at measurable levels, and if there are no other sources of the chemicals in question. Even if compounds are not present in identical concentrations, their relative concentrations should be maintained if there are no other sources. This concept can also be applied to the sums of classes of compounds, for example the ratio of aromatics to aliphatics.

A variety of graphical techniques can be used to help communicate this concept. For example, one option is to plot concentrations of one compound versus concentrations of another compound on an x-y plot, as shown on Figure 7-3, below for benzene and MTBE (Berry-Spark et. al., 2004). These data were collected at a former MGP site, where subsurface releases from a century ago included benzene, but not MTBE, which has been used only in recent decades as an octane enhancer in gasoline. In this case, the indoor air samples showed a positive correlation between the concentration of benzene and MTBE, whereas the subsurface vapor concentrations did not. The ratio of benzene to MTBE in outdoor air was similar to the ratio of benzene to MTBE in indoor air. MTBE concentrations in soil gas samples were generally lower than outdoor air MTBE concentrations. With this presentation, the source of benzene and MTBE in indoor air appears much more likely to be related to gasoline than subsurface vapor intrusion.

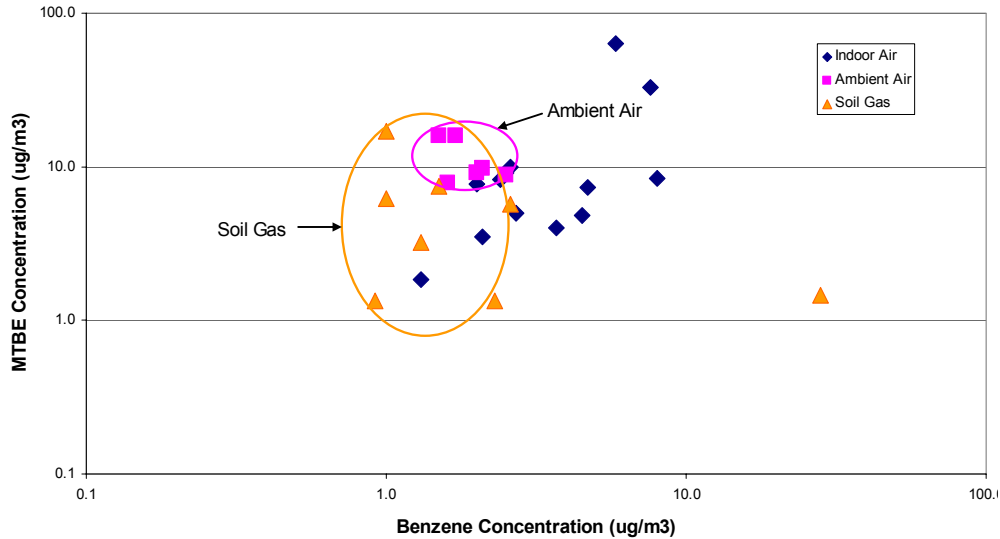
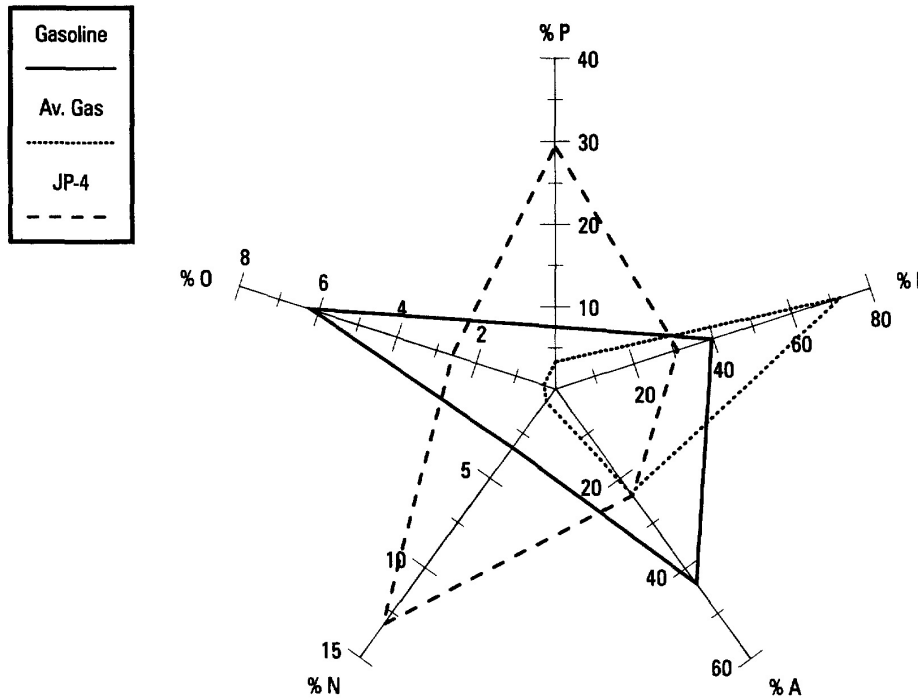

**Figure 7-3**  
**Comparison of Relative Concentrations of Two Compounds (Berry-Spark et. al, 2004)**

Ratios of more than two compounds can be visually assessed using multi-linear diagrams (e.g. Kaplan, et. al., 1997). These diagrams use more than two axes, and the concentrations of each constituent in a multi-component mixture are plotted on their respective axes. A line is drawn to connect the plotted points, and this outline will have a characteristic shape, attributable to the relative concentrations of the constituents in the mixture. If soil gas and indoor air samples have the same characteristic shape, subsurface vapor intrusion is more likely to be the source of the indoor vapors than if the outlines have distinctly different shapes, in which case, a contribution from background or ambient sources is more likely. An example of a multi-linear plot is shown in Figure 7-4, below. It may be necessary to use logarithmic scales or normalized concentrations (e.g.  $C/C_{max}$ ) when comparing soil gas to indoor air data, which will often have orders of magnitude differences in absolute concentrations.

Similar qualitative graphical comparisons of multi-component mixtures can also be made using chromatographs, with comparison of the elution time and peak heights of various constituents. Chromatographs are generally available by special request from the laboratory performing chemical analysis of the soil gas and indoor air samples.

Multiple samples may be necessary or appropriate for interpretation of ratios of two or more compounds, particularly where the subsurface distribution of different constituents may not all be the same, such as when there are multiple release areas, or the constituents have differing rates of natural biodegradation, hydrolysis or decay.



**Figure 7-4**  
**Multi-linear Diagram for comparison of different constituents in fuel mixtures (Kaplan, et al., 1997)**

### 7.2.8 Interpolation and Extrapolation

Wherever there is any unacceptable subsurface vapor intrusion, there may be questions regarding the extent of the impact. Where data are sufficient to allow spatial and temporal trend analysis by statistical methods or visual inspection, the trends should be analyzed and included in assessment reports. In some cases, interpolation or extrapolation may be possible using statistical methods, but in most cases, the data will not support analysis by mathematical methods, and will require professional judgment. Data variability will make interpolation and extrapolation decisions more difficult, which is part of the justification for the level of detail in the recommended methods in this document.

It may be appropriate to plot data as ranges of subsurface or indoor air concentrations normalized to a target concentration, background concentration, or laboratory reporting limits, instead of the absolute value of the measured concentrations, in order to normalize the results where multiple compounds with differing proportions or toxicities are present. It may also be appropriate to define a zone where mitigation is required, a perimeter where mitigation is not required, but monitoring will be performed at some specified frequency and duration (with a contingency for mitigation if monitoring data indicate a need), and a third zone where monitoring will not be routinely performed unless adjacent areas evolve from a monitoring-only to mitigation status.

Short-term temporal trends in response to weather (wind, barometric pressure, rain, etc.) can cause variability in vapor intrusion. In the context of a 30-year exposure scenario, long-term average concentrations are more relevant. Short-term variability may make it difficult to discern

any longer-term trends, for example increasing concentrations as chemicals migrate away from a source, or decreasing concentrations as a release of contaminants degrades by intrinsic microbial activity. Sampling methods that minimize short-term variability would be preferable, such as samples that are collected over a longer duration (see Section 10.4).

Long-term monitoring should be considered when a significant vapor intrusion condition is identified, unless remedial measures are designed such that the condition will be permanently eliminated. If engineered controls include active systems, a program should be implemented for periodic verification of the system operation and maintenance.

Mathematical models can be very useful in support of the spatial and temporal interpolation. This may include groundwater flow and transport models (Modflow, RT3D, Bioscreen, Biochlor, etc.), subsurface vapor transport models (Mendoza and Frind, 1990, Air-3D, etc.), or specific vapor intrusion models (e.g. Abreu and Johnson, 2004, the J&E (1991) Model, or customizations). Mathematical models provide an ability to simulate future conditions, which is one of the most important ways of extrapolating into the future. Subsurface vapor transport rates tend to diminish as the age of the release increases, an analysis of which was provided by Mendoza (1995).

### **7.3 Risk Assessment and Risk Management**

Appendix H (Courtesy of Menzi-Cura & Associates) provides general guidance for conducting human health risk analyses of the subsurface vapor intrusion (SVI) exposure pathway. Such risk analyses can range from simple risk-based screening to site-specific risk assessment, depending on information needs and applicable regulatory requirements. This appendix will help individuals determine whether any SVI effect on indoor air quality poses a significant risk to human health. If remediation is warranted, it provides guidance for defining risk-based remediation goals.

One of the most important aspects of risk assessment is establishing an appropriate exposure scenario, which may vary from receptor to receptor. The exposure duration, frequency, inhalation rate may all vary depending on the property use, and occupant's habits. In some jurisdictions, these parameters are specified. Common Equations used for Risk Assessment are presented in the table below. Resources for risk assessors are available on-line at:

**EPA Superfund Risk Assessment:** <http://www.epa.gov/superfund/programs/risk/tooltrad.htm>

<http://www.epa.gov/iris/>

**HEAST:** EPA, Office of Research and Development. Health Effects Assessment Summary Tables. July 1997.

**OPP-CAN:** EPA, Office of Pesticide Programs. List of Chemicals Evaluated for Carcinogenic Potential (5/10/2002). OPP, Washington, DC.  
<http://www.epi.uci.edu/valleycenter/EPAListCarcinogenicChemicals.pdf>.

**OPP-RfD:** US EPA, Office of Pesticide Programs. RfD Tracking Report (2/97). OPP, Washington, DC. Obtained as an electronic file (ProdVol.dbf); available online at <http://ace.orst.edu/info/npic/tracking.htm>.

**SCDM:** EPA, Office of Emergency Response and Remediation. *Superfund Chemical Data Matrix*.

The chart on the following page provides the common equations used to calculate cancer and non-cancer risks and target concentrations, along with typical default values for commercial and residential exposures. Other equations may be appropriate, depending on site-specific conditions.

## Common Risk Assessment Equations

### 1) Calculation of Chemical Intake by Vapor Inhalation

$$\text{Intake (mg/kg/day)} = \frac{\text{Cair} \times \text{IR} \times \text{ET} \times \text{EF} \times \text{ED}}{\text{BW} \times \text{AT} \times 1,000 \text{ ug/mg}}$$

### 2) Calculation of Risks

$$\text{Carcinogens: Incremental Lifetime Cancer Risk} = \text{Intake} \times \text{CSF}$$

$$\text{Non-carcinogens: Hazard Quotient} = \text{Intake} / \text{RfD}$$

### 3) Calculation of Risk-Based Indoor Air Concentrations (RBC)

$$\text{Carcinogens: RBC (ug/m}^3\text{)} = \frac{\text{TR} \times \text{AT} \times \text{BW} \times 1,000 \text{ ug/mg}}{\text{ET} \times \text{EF} \times \text{ED} \times \text{IR} \times \text{CSF}}$$

$$\text{Non-carcinogens: RBC (ug/m}^3\text{)} = \frac{\text{THQ} \times \text{AT} \times \text{BW} \times \text{RfD} \times 1,000 \text{ ug/mg}}{\text{ET} \times \text{EF} \times \text{ED} \times \text{IR}}$$

Symbol	Variable	Value for Residential Scenario	Value for Commercial / Industrial Scenario	Units
AT	averaging time for carcinogens	(70 x 365) for carcinogens and (ED x 365) for noncarcinogens	(70 x 365) for carcinogens and (ED x 365) for noncarcinogens	days
BW	body weight	70 for adult	70 for adult	kg
Cair	chemical concentration in air	chemical-specific measured or calculated	chemical-specific measured or calculated	ug/m <sup>3</sup>
CSF	cancer slope factor	chemical-specific	chemical-specific	(mg/kg/d) <sup>-1</sup>
ED	exposure duration	30	25	yrs
EF	exposure frequency	350	250	days/yr
ET	exposure time	24	typically 8, but can be dependent upon building occupation	hours/day
IR	inhalation rate	0.83 (= 20m <sup>3</sup> /day)	2.5 (=20m <sup>3</sup> per 8-hour work day), or use age, sex and activity based values in US EPA 1997	m <sup>3</sup> /hr
RfD	reference dose	chemical-specific	chemical-specific	mg/kg/d
TR	target cancer risk	1 x 10 <sup>-6</sup>	1 x 10 <sup>-6</sup>	--
THQ	target hazard quotient	1	1	--

#### Notes and References:

- 1) Intake equations were taken from Exhibit 6-16 of US EPA December 1989 (EPA/540/1-89/002) "Risk Assessment Guidance for Superfund Volume I Human Health Evaluation Method (Part A)".
- 2) Residential and commercial / industrial values obtained from US EPA March 25, 1991 "Risk Assessment Guidance for Superfund Volume I: Human Health Evaluation Manual Supplemental Guidance "Standard Default Exposure Factors" Interim Final."
- 3) Sex, activity and age – specific hourly inhalation rates are provided in US EPA August 1997 (EPA/600/P-95/002Fa) "Volume I – General Factors Exposure Factors Handbook (Update to Exposure Factors Handbook EP/600/8-89/043 – May 1989).
- 4) The values in this table are those provided by US EPA and may not be applicable to all regulatory jurisdictions.

Risk Management is the process for selecting appropriate alternatives for maintaining exposures within acceptable limits. Risk management should include consideration for data variability and uncertainty, and err on the side of caution. Risk management may involve input from multiple stakeholders. Technologies to control vapor intrusion are described in Chapter 9. The urgency of implementation should be proportional to the concentrations. Other factors (exposure frequency and duration, differences between regulatory jurisdictions, etc.) may dictate more cautious responses, but in general, responses should be similar to the following suggestions:

- >LEL or IDLH - evacuate immediately, ventilate before re-entry
- >STEL or PEL - don respirator, take measures to reduce exposures immediately
- >ASTDR Acute MRL - prohibit exposures of >1 day
- >ASTDR Intermediate MRL - prohibit exposures of > 2 weeks
- >ASTDR Chronic MRL - prohibit exposures > 1 year
- >10X target indoor air quality (TIAQ) - mitigate concentrations
- >0.1 but < 10X TIAQ - confirmatory monitoring, mitigate concentrations >TIAQ
- < 0.1X TIAQ - no further action



# 8

## MITIGATION

---

This chapter discusses the various options available for vapor mitigation systems and the expected effectiveness for each. In practice, mitigation measures that must be added as a retrofit to an existing building will generally be different than measures which can be integrated into the design and construction of the building, so this section is presented in two subsections.

### 8.1 Methods/Technologies for Existing Buildings

#### *8.1.1 Sub-Slab De-Pressurization*

Sub-slab depressurization is the most common form of control for subsurface vapor intrusion. In simple terms, a vacuum is applied to the region beneath the floor slab, maintaining a pressure differential sufficient to prevent vapor intrusion. The floor slab is usually underlain by granular fill for structural support, and the granular fill is usually sufficiently permeable to facilitate extraction of sub-slab soil gas and propagation of a vacuum. As a result, a single extraction point connected to a fan of approximately 50 to 150 Watts is usually sufficient to achieve reductions in indoor air concentrations by 2 or 3 orders of magnitude. Monitoring to confirm the effectiveness may be as simple as installation of a couple of dedicated vacuum gauges, one connected to the extraction point, to verify the vacuum achieves some target level (typically a few inches of water column or more), and a second one at a remote location to demonstrate that the vacuum is propagating across the floor to some degree (typically 6 to 9 pascals, ASTM, 2001). These systems are analogous to radon mitigation systems, and over 250,000 such systems have been installed across the United States. The fans are rated for continuous duty and last several years between replacements. Figure 8-1 shows a typical design. Figure 8-2 shows performance monitoring data demonstrating a reduction of 3 orders of magnitude in concentrations of 11DCE after initiation of sub-slab depressurization (Folkes et al, 2000). Concentrations of several other compounds were not affected, which is a clear indication that the source of these other vapors was background contributions. These figures also point out that verification monitoring by indoor air sampling and analysis is problematic, because background sources cannot be eliminated, therefore, vacuum and flow monitoring are preferred.

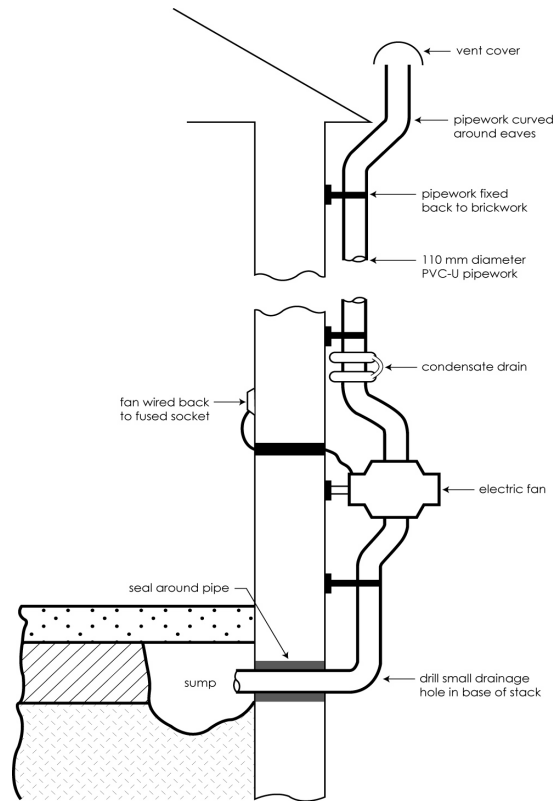

Figure 8-1  
Typical Design for a Sub-Slab Venting System (schematic)

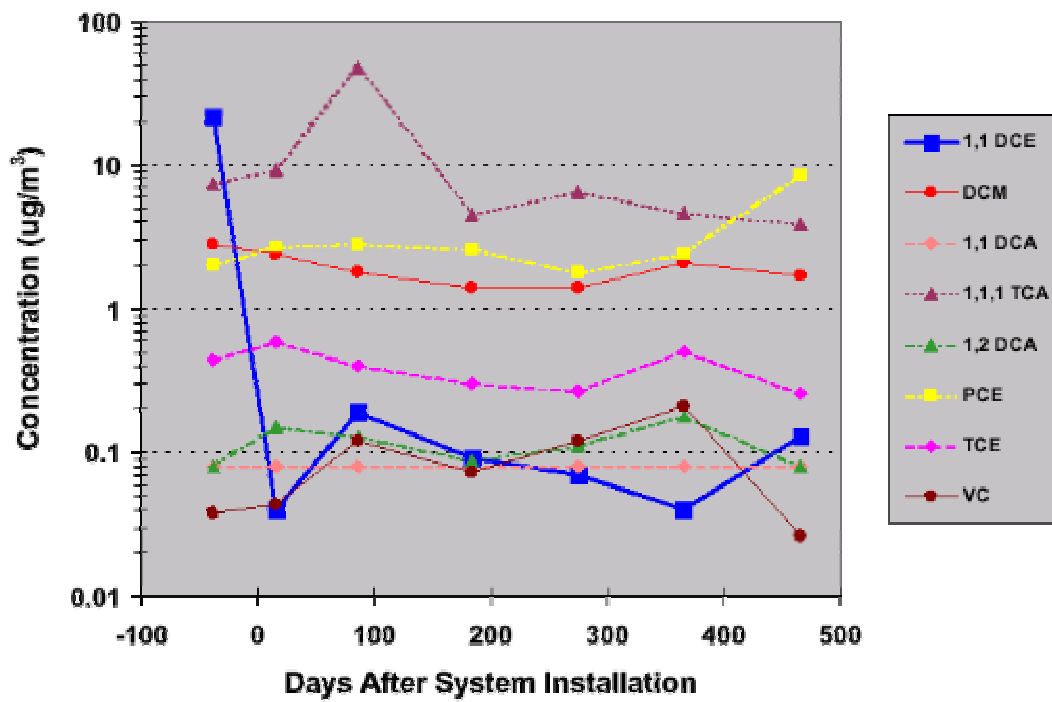

Figure 8-2  
Performance Data from a Sub-Slab Depressurization System (Folkes, 2000)

Sub-slab depressurization is a containment technology, and is not designed to remove the source of the subsurface vapors. Therefore, institutional controls will be required to ensure that the systems continue to operate as designed. Over time, the continuous flushing of subsurface gases may accomplish this serendipitously, but the majority of gas flow will probably be through the granular fill, and much less through natural soils. If at any time the fan breaks down, vapor intrusion can occur again in very short order, which may not be a concern if the concentrations only pose a long-term health effect, but may be a very significant concern if methane gas or offensive odors (e.g. H<sub>2</sub>S) are involved. There have been some cases where direct discharge from a sub-slab venting system to outdoor air beside a home resulted in a measurable increase in VOC concentrations in indoor air in the adjacent home, which is a risk that cannot be ignored if indoor air quality data is collected using TO-15 SIM or similarly sensitive methods.

### **8.1.2 Soil Vacuum Extraction**

Soil vacuum extraction (SVE) is similar to sub-slab venting, but at a larger scale, with a more aggressive design. SVE is generally intended to remove soil vapors from throughout the vadose zone, accomplishing containment in the short-term and restoration over time. SVE systems will generally require more infrastructure (larger blowers, water knock-out, off-gas treatment through multiple carbon filters in series, and sometimes telemetry and programmable logic controls), permits, regular monitoring, and progress reporting. Off-gas treatment requirements may need to be more stringent than a conventional SVE system if outdoor air quality monitoring is being conducted using Method TO-15 SIM or equivalent.

One of the key considerations for SVE is the radius of influence of each extraction well, and the effort associated with connecting multiple extraction points in a developed setting. Pneumatic testing is often required to develop an effective design. If the source of VOC vapors is off-gassing from the water table, the SVE system may not be able to achieve restoration, unless a groundwater remedy is also implemented.

In some cases, it may be advantageous to control subsurface vapor intrusion by removing the source of subsurface vapors, rather than, or in addition to blocking the pathway to indoor air. SVE will often be the preferred technology for this approach, although in some case, it may be appropriate to consider excavation (see Section 10.3.2) or other remediation technologies.

### **8.1.3 Building Pressurization**

Building pressurization may be as effective as sub-slab de-pressurization for maintaining a pressure gradient across the floor slab sufficient to reduce or eliminate subsurface vapor intrusion. For commercial and industrial buildings where HVAC units are usually mounted on the rooftop and blowing air into the building, it may simply be a matter of running the fans continuously, increasing the air flow rate, and/or installing additional units. Mechanical engineers use a variety of specialized equipment to monitor and balance air flow rates, as shown on Figure 8-3.

In some climates, the energy required to heat or cool air may make this alternative prohibitively expensive. Long-term administrative controls would be required and may be challenging to monitor or audit.



**Figure 8-3**  
**Monitoring Air Flow to Balance Pressure within a Building**

#### ***8.1.4 Sealing Cracks, Sumps, Sewers, and Other Potential Conduits***

Just as sealants can be used to prevent water from entering a basement through discontinuities, they may also prevent or reduce vapor intrusion. Sealants made with current technology (urethane) are very durable and can be expected to last for decades. Holes drilled along cracks can be used to inject sealants to facilitate good penetration and adherence, as shown in Figure 8-4. If an industrial building is planned for re-development, it is often a good idea to seal the entire floor, since historic releases of solvents may have permeated the pores within the concrete. Where cracks are accessible to be sealed, this method may result in a reduction in vapor intrusion, but the magnitude of the reduction achieved by sealing alone will probably be less than the reduction achieved by methods that actively manipulate pressure gradients.

Anyone who has tried to fix a wet basement knows that sealing one crack often will encourage water (or vapors) to simply enter through another nearby crack. In finished or partially finished basements, it may be difficult to locate and seal cracks, as these may be obscured behind floor and wall coverings. In the short-term after application, some sealants will emit VOC vapors, which should be considered as a precaution during performance monitoring.



**Figure 8-4**  
**Use of Sealants to prevent Vapor Intrusion Through Cracks**

### **8.1.5 Air Filtration**

Indoor air quality can be improved using filtration units, for example a drum of activated carbon fitted with a blower or fan that circulates indoor air through the carbon, trapping VOCs and SVOCs. These filters typically use activated carbon to trap VOC vapors, and come with an integral fan unit that circulates air through them. They are readily available, can be set up and running in very short order, and provide tangible results almost immediately. The activated carbon requires replacement on a regular basis, which makes this technology generally less attractive for long-term applications.

## **8.2 Methods/Technologies for Future Buildings**

Brownfield re-development is a growing opportunity, but vapor intrusion concerns must be considered and in some cases, may pose a potential risk to a hypothetical future building. The technologies described in Section 10.1 can be used after building construction, but there are also several methods of mitigation that can be incorporated in the building design or construction, as described below.

### **8.2.1 Intrinsically Safe Building Design**

Seashore properties in areas prone to flooding are often built on stilts, to maintain a position that is “high and dry”. This design can be just as effective for preventing vapor intrusion. Whether residential or commercial, the space beneath the building can be used for parking, and may be appreciated in areas of intense sunlight, rain or snow.

If the building is multiple stories, it would be important to ensure that an elevator shaft is not installed to run from ground level (with a subsurface pit). The motion of an elevator acts like a piston, and soil gas can be drawn into the elevator shaft and subsequently distributed throughout the building. It is also important that ambient air be allowed to flow beneath the building, so lateral security walls should be vented, which may also help to ensure that automotive emissions do not accumulate if the space under the building is used for automotive parking.

### **8.2.2 Vapor Barriers and Ventilation Layers**

Subsurface vapor control can be achieved by a vapor barrier and ventilation layer beneath a building. Incorporating these features is relatively inexpensive if placement occurs before the building slab is constructed and the utilities are placed. The most common design consists of a highly permeable layer of granular fill with vent pipes overlain by welded plastic sheets (geomembrane). The vent pipes are connected to a common header that is connected to a blower that can either run continuously, or be automated to run when sensors beneath the building indicate that vapors are accumulating. Construction quality assurance supervision is essential, especially to ensure that the seams of the geomembrane are sealed properly, and that the membrane is not perforated prior to placement of the concrete slab. Figures 8-5 and 8-6 show a typical installation.



**Figure 8-5**  
**Multiple Layers for Venting Being Installed Prior to Construction**



**Figure 8-6**  
**Gravel Being Placed over Geomembrane Prior to Concrete Slab**

One technology that has been specifically developed to seal beneath buildings is a product called Liquid Boot™, a water-based sealant that remains flexible after spray-application, and is therefore resistant to tearing from differential settlement, and may form more effective seals around utility penetrations.

### **8.2.3 Excavation of Contaminated Soil and Replacement with Clean Fill**

During re-development, it is often preferable to select expeditious remedial actions; therefore, excavation and disposal is often a preferred remedy for soil remediation. Backfill material will often be imported to return the excavated area to grade. Backfill materials are often coarse-textured and well-drained for geotechnical reasons (minimal compaction effort, good bearing strength, resistance to frost heave), but these same granular materials may act as preferential pathways for vapor transport. Therefore, excavation may not be sufficient as a mitigation method for vapor intrusion, and may need to be monitored, and/or potentially supplemented with some form of vapor barrier or venting system for long-term protection against vapor intrusion.

## **8.3 Administrative Controls**

In cases where subsurface vapor intrusion requires on-going mitigation, administrative controls should be considered and applied where available and appropriate until such time as the subsurface concentrations no longer pose a potential risk.

## **8.4 Monitoring**

Where subsurface vapor intrusion has been identified and found to be above regulatory target levels, it may be necessary to monitor conditions over time. If a mitigation system is installed, it should be monitored to confirm it is performing as intended and continues to operate as designed. Where chemicals are attenuating naturally, monitoring may be appropriate to assess the rate and extent of attenuation over time.

Monitoring programs will require site-specific design, but several considerations will be common, including the frequency, duration, scope, methods of sampling and analysis, target analyte list, and framework for interpretation, each of which is described in the paragraphs below.

Monitoring frequency should be sufficient to discern long-term trends, but not short-term fluctuations (diurnal or weather-related), which will tend to be averaged over a 30-year exposure scenario. Winter and summer sampling is probably sufficient for initial site characterization, and annual sampling is likely to be sufficient for longer-term monitoring. If sampling is conducted once annually, it may be most conservative to conduct the monitoring during the coldest month of the year, when the stack effect would be expected to be most significant. In some locations, air conditioning is required throughout the year, so the time of year may not be as important. Shorter monitoring intervals may be necessary during start-up testing and shakedown of mitigation systems.



The duration of sampling may need to continue until the mass of chemicals of concern has been permanently reduced to levels that pose no future threat until an effective passive remedial technology is invented, or toxicological information changes target indoor air concentrations to more lenient levels, each of which is a condition that can only be assessed on a case-by-case basis.

The scope of sampling should consider the number of buildings that might either require mitigation or be in near proximity (within one or two residential lots) of areas requiring mitigation. The number of samples for each media (indoor air, outdoor air, soil gas, and groundwater) should be considered carefully, and locations should be as consistent as possible from event to event to assist with comparing data over time. Barometric pressure monitoring, and pressure differential from indoor air to sub-slab air should be considered, especially where a sub-slab depressurization system is in place and these data are critical to performance assessment. Soil gas flow and vacuum readings can be included to assess whether subsurface gas permeability changes over time, which can occur if moisture content is variable.

The monitoring program should include a plan for data analysis, including methods for assessing temporal trends (linear regression, with test for significance of the slope of the line, etc), assessing differences between populations (T-test to compare indoor air to outdoor air, or indoor air to published background data), fingerprinting (via ratios of detected compounds or tracers) or analysis of variance (ANOVA) to compare the suite of detected analytes in subsurface samples to indoor air. Such analyses should be considered in addition to simple comparison of indoor air concentrations to risk-based target concentrations, which has a high risk of a false positive determination attributable to background sources.



# 9

## RESEARCH NEEDS

---

There are several possible ways of investigating subsurface vapor intrusion that have not been discussed earlier in this document. Some of these methods have not been proven or require further study to evaluate their effectiveness. Research will help to assess whether and under what conditions these methods may be useful as additional tools in the toolbox of investigative techniques.

### 9.1 Indoor Air Sampling With and Without Pressure Changes

Indoor air samples can be collected under two conditions: with and without building pressurization or sub-slab depressurization. In either circumstance, the pressure change can be used to block subsurface vapor intrusion and the difference between these two samples should represent the concentration contributed from the subsurface, providing subsurface vapor intrusion is contributing vapors to indoor air at detectable concentrations. If the samples collected before and after manipulating the pressure gradient are essentially the same, this test provides convincing evidence of the absence of significant vapor intrusion. Furthermore, it can also provide a clear indication of chemicals that are attributable to subsurface vapor intrusion and those that are not. For example, Figure 8-2 shows indoor air quality data collected before and after the implementation of a sub-slab de-pressurization system. The concentrations of 1,1-dichloroethene (11DCE) decreased by about 2 orders of magnitude upon implementation of the system; however, concentrations of several other VOCs were not affected. This provides a clear demonstration of the sources of these compounds.

Sub-slab depressurization can be accomplished by connecting a sub-slab probe to a pump to withdraw soil gas at a rate sufficient to create a vacuum of 6 to 9 pascals or more at two or more remote sub-slab probes used for monitoring. The extracted gas would need to be discharged outdoors and it may be prudent to have a carbon-filter inline to prevent re-cycling of vapors via outdoor air return into the building. The net effect on concentrations of vapors from sources inside the building will probably be negligible.

A similar strategy can be invoked by fitting a window with a fan, and blowing air into the building, but significantly higher flow rates are typically required to maintain the same pressure differential, and this may affect occupant comfort, especially during warm or cool weather. It will also likely affect the concentration of vapors from source inside the building by dilution (proportional to the increase in the ventilation rate). For commercial buildings, where the heating or air conditioning units normally are on the roof and blow air into the building, it may be possible to adjust their flow rates as a mitigation measure against subsurface vapor intrusion.

## 9.2 Headspace Screening for Very Low Permeability Soils

In some cases, soils with low permeability may not yield a soil gas without either excessive vacuum, or a very long sample collection interval (for example, if a vacuum of 100 inches of water produces less than 1L of soil gas over the course of an hour). In such cases, soil gas sampling according to the protocols described in this document may not provide representative data.

In soils of such low permeability, a core can usually be collected with minimal volatilization losses because the cohesion prevents exposure of the interior of the soil core to the atmosphere, and minimizes volatilization. In a sealed inert container, the soil can be allowed to re-equilibrate with a small headspace, sufficient for direct gaseous injection analysis (typically <<1 mL), but not sufficient to act as a significant mass sink (<10% of the total soil volume). Laboratory headspace analysis is often performed after heating the sample vial to promote mass transfer to the headspace, but for this method, it would be best to keep the temperature as similar as possible to the average subsurface temperature at the site where the soil was collected. A direct comparison of soil core headspace analysis to soil gas probe sampling and analysis could be performed with relatively little additional expense. Multiple samples would probably be required to assess spatial variability. The relatively small volume of gas that could be sampled for direct injection would probably result in detection limits considerably higher than a typical TO-15 analysis, so this method may only be feasible for assessing vapor source zones.

## 9.3 Use of Naturally Occurring Radon as a Tracer

Radon testing has been performed for years to assess indoor air quality. It may be possible to sample radon in sub-slab soil gas and indoor air in order to demonstrate the relative contribution of sub-slab soil gas to indoor air. This sub-slab attenuation factor could then be multiplied by subslab VOC concentrations to estimate the concentration of those VOCs in indoor air attributable to subsurface vapor intrusion. If so, the need for indoor air samples for VOC analysis might be avoided, along with the challenges associated with determining the relative contributions from consumer products, building materials, outdoor air and other background sources.

Radon samples are usually collected using an electret, shown in Figure 10-1. These are passive samplers, and may not be well suited to collecting samples of soil gas. Research will help to assess the best way to collect comparable long-term average concentration data from both the indoor air and sub-slab gas that are relevant and appropriate for use as a tracer for VOC migration.

Radon monitoring may not be feasible where naturally occurring concentrations are too low. A map of radon concentrations in the United States is shown on Figure 10-2.

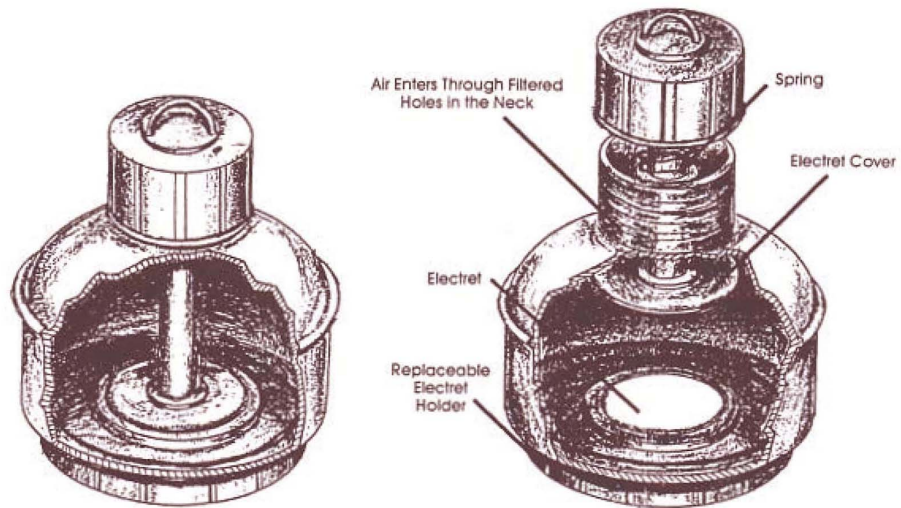

**Figure 9-1**  
**Radon Electret (epa.radon.gov)**

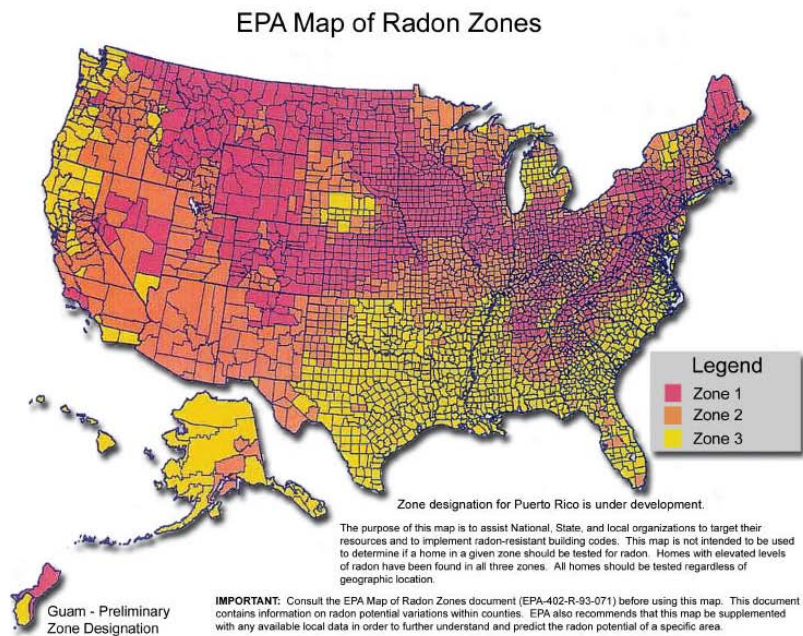

**Figure 9-2**  
**Map of Radon Concentrations (epa.radon.gov)**

## 9.4 Longer Term Integrated Average Samples

Sample duration can also include considerations of the interval of time-weighted average sample collection, which are commonly 8-hour in commercial/industrial settings, and 24-hour in residential settings. It may be advantageous to collect samples over a longer period, to minimize temporal variability imposed by weather related effects (barometric pressure, wind, rain, etc.). This approach was adopted for radon monitoring. Method development is required to demonstrate the feasibility of this approach considering the limitations of Summa™ canister flow controllers and sorptive media sampling pumps.

## 9.5 Mathematical Modeling

Increasingly complex models are capable of simulating scenarios that have not been possible in the past. The complexity of such simulations would be prohibitive for most individual site investigations. Therefore, it would be appropriate to create a number of simulations of typical scenarios that will help with general understanding, particularly for scenarios that are not incorporated in screening-level models (biodegradation, barometric pumping, water table fluctuations, preferential pathways, etc.). EPRI has proposed to validate the more complex models by appropriate teams of practitioners so as to develop easy to use screening tools (nomographs and computerized tools).

## 9.6 Intrinsic Aerobic Biodegradation

Field methods to characterize the occurrence and factors controlling intrinsic aerobic biodegradation are important, and require development. Degradation has been documented for petroleum hydrocarbons (Roggemans et al, 2001, Lahvis, etc). Chlorinated hydrocarbons are generally resistant to aerobic degradation, except vinyl chloride. PCBs, PAHs, and pesticides are also generally resistant to aerobic degradation. Basic research is required to assess whether and to what extent buildings inhibit recharge of oxygen to the subsurface, potentially limiting aerobic degradation below the footprint.

## 9.7 Forensics

Methods for fingerprinting compounds from subsurface sources to distinguish them from indoor sources should be developed, possibly including stable isotope ratios, signature compounds for different mixtures, tracers, statistical methods of analysis, or graphical presentation techniques. EPRI and others have proposed studies to evaluate several of these methods.

## 9.8 Background

As discussed earlier in Chapter 7, comparison of indoor air data to background and ambient air quality is challenging due to old and inadequate data. EPRI, USEPA, and some state regulators are working on studies to enhance this database, and synthesize useable data from several sources, and the result of some of these investigations is expected to be available in the 2005-2007 time frame.

# 10

## REFERENCES

---

- Abreu, L.D.V. and P.C. Johnson, 2005a. Effect of Vapor Source-Building Separation and Building Construction on Soil Vapor Intrusion as Studied with a Three-Dimensional Numerical Model. *Environ. Sci. Technol.* (in press).
- Abreu, L.D.V. and P.C. Johnson, 2005b. Modeling the Effect of Aerobic Biodegradation on Soil Vapor Intrusion into Buildings – Influence of Degradation Rate, Source Concentration, and Depth. *Environ. Sci. Technol.* (in press).
- ACGIH (American Conference of Governmental Industrial Hygienists). 1999. TLVs and BEIs, Threshold Limit Values for Chemical Substances and Physical Agents. Biological Exposure Indices. Cincinnati, OH.
- Acomb, L., C. Rea, T. Simpkin, R. Hoffman, and B. Elder, 1996. Intrinsic Remediation of Shallow Vadose-Zone Hydrocarbons. The Proceedings of the API/NGWA Petroleum Hydrocarbons and Organic Chemicals in Groundwater: Prevention, Detection and Remediation, Houston, TX, 13-15 November 1996.
- Adgate, J.L., T.R. Church, A.D. Ryan, G. Ramachandran, A.L. Fredrickson, T.H. Stock, M.T. Morandi, and K. Sexton (2004): Outdoor, Indoor, and Personal Exposure to VOCs in Children. *Environ. Health Perspectives*, 112(14): 1386-1392.
- Agency for Toxic Substances and Disease Control (ASTDR), 2004. ASTDR Minimal Risk Levels: [http://www.atsdr.cdc.gov/mrllist\\_03\\_04.pdf](http://www.atsdr.cdc.gov/mrllist_03_04.pdf)
- Ahlers, C.F., S. Finsterle, and G.S. Bodvarsson. 1999. *Characterization and Prediction of Subsurface Pneumatic Response at Yucca Mountain, Nevada*. *Journal of Contaminant Hydrology*, 38:47-68.
- Alvarez, P. J. J., 2001, *Effect of ethanol on BTEX natural attenuation: Biodegradation, kinetics, geochemistry, and microbial community implications*, in Proceedings of the Workshop on the Increased Use of Ethanol and Alkylates in Automotive Fuels in California, April 10-11, Oakland, California, Lawrence Livermore National Laboratory.
- AIHA (American Industrial Hygiene Association). 1998. *The AIHA 1998 Emergency Response Planning Guidelines and Workplace Environmental Exposure Level Guides Handbook*.
- American Petroleum Institute (API), 1994. Transport and Fate of Non-BTEX Petroleum Compounds in Soils and Groundwater, Health and Sciences Department, API Publication # 4593, Washington, DC.

---

References

- American Petroleum Institute (API), 1998. Assessing the Significance of Subsurface Contaminant Vapor Migration to Enclosed Spaces, Site-Specific Alternatives to Generic Estimates. Publication No. 4674. Health and Environmental Sciences Department. Washington D.C.
- American Petroleum Institute (API), 2004. Collecting and Interpreting Soil Gas Samples from the Vadose Zone: A Practical Strategy for Assessing the Subsurface-Vapor-to-Indoor-Air Migration Pathway at Petroleum Hydrocarbon Sites, Final Draft, October 2004.
- American Society of Heating Refrigerating and Air Conditioning Engineers (ASHRAE). 1985. ASHRAE Handbook (1985) Fundamentals. Chapter 22. Atlanta, GA.
- ASHRAE. 1998. The ASHRAE Handbook CD [CD-ROM]. Atlanta: American Society of Heating, Refrigerating, and Air-Conditioning Engineers. 1995 ASHRAE Handbook-HVAC Applications. Ch 32 Energy management.
- ASHRAE Standard 62-1999. 1999. Ventilation for acceptable indoor air quality. Atlanta: American Society of Heating, Refrigerating, and Air-Conditioning Engineers, Inc.
- American Society for Testing and Materials (ASTM), 1990. *Standard Practice for Analysis of Reformed Gas by Gas Chromatography*. D1946-90(2000), Vol. 05.06. West Conshohocken, PA.
- American Society for Testing and Materials (ASTM), 1990, Test method for laboratory determination of water (moisture) content of soil and rock, ASTM D 2216-90, *American Society for Testing and Materials*, West Conshohocken, Pennsylvania, Annual Book of ASTM Standards, v. 04:08.
- American Society for Testing and Materials (ASTM), 1991, Standard guide for soil sampling from the vadose zone, ASTM D 4700-91, *American Society for Testing and Materials*, West Conshohocken, Pennsylvania, Annual Book of ASTM Standards, v. 04:08.
- American Society for Testing and Materials (ASTM), 1992, Test method for specific gravity of soil, ASTM D 854-92, *American Society for Testing and Materials*, West Conshohocken, Pennsylvania, Annual Book of ASTM Standards, v. 04:08.
- American Society for Testing and Materials (ASTM), 1992, Standard guide for soil gas monitoring in the vadose zone, ASTM D 5314-92, *American Society for Testing and Materials*, West Conshohocken, Pennsylvania, Annual Book of ASTM Standards, v. 04:09.
- American Society for Testing and Materials (ASTM), 1993, Standard test method for determining a sorption constant (Koc) for an organic chemical in soil and sediments, ASTM E1195-87(1993), *American Society for Testing and Materials*, West Conshohocken, Pennsylvania, Annual Book of ASTM Standards, v. 04:09.
- American Society for Testing and Materials (ASTM), 1995, Standard guide for risk-based corrective action applied at petroleum release sites, ASTM E 1739-95, *American Society for*



- Testing and Materials*, West Conshohocken, Pennsylvania, Annual Book of ASTM Standards, v. 04:09.
- American Society for Testing and Materials (ASTM), 1996, Standard test method for particle size analysis, ASTM D 422-96, American Society for Testing and Materials, West Conshohocken, Pennsylvania, Annual Book of ASTM Standards, v. 04:08.
- American Society for Testing and Materials (ASTM), 1999. *RBCA Fate and Transport Models: Compendium and Selection Guidance*. Technical & Professional Training series.
- American Society for Testing and Materials (ASTM), 2001. Standard Practice for Installing Radon Mitigation Systems in Existing Low-Rise Residential Buildings, Designation: E 2121 – 03 Copyright © ASTM International, 100 Barr Harbor Drive, PO Box C700, West Conshohocken, PA 19428-2959, United States.
- American Society for Testing and Materials (ASTM), 2003. *Standard Test Method for Analysis of Natural Gas by Gas Chromatography*. D1945-03, Vol. 05.06. West Conshohocken, PA.
- Anderssen, B., and B. Markey. 1997. *Indoor Infiltration of Volatile Organic Contaminants: Coupling Above-To Below-Ground Via a Nonhomogeneous Surface Boundary*. Journal of Soil Contaminant, 6(1):15-19.
- Andino, J.M., J.W. Butler. *A Study of the Stability of Methanol-Fueled Vehicle Emissions in Tedlar™ Bags*. Env. Sci. Technol.
- Arkin, Herbert and R.R. Coulton. 1970. *Statistical Methods*. 5<sup>th</sup> edition. Barnes and Noble Books. New York.
- ASHRAE (American Society for Heating Refrigerating and Air Conditioning Engineers). 1985. *ASHRAE Handbook Fundamentals*. Chapter 22. Atlanta, GA.
- ATSDR (Agency for Toxic Substances and Disease Registry). 2002. *Minimal Risk Levels (MRLs) for Hazardous Substances*. <http://www.atsdr.cdc.gov/mrls.html>.
- Auer, L.H., N.D. Rosenberg, K.H. Birdsell, and E.M. Whitney. 1996. *The Effects of Barometric Pumping on Contaminant Transport*. Journal of Contaminant Hydrology, 24:145-166.
- Baehr, A.L. 1987. *Selective Transport of Hydrocarbons in the Unsaturated Zone due to Aqueous and Vapor Phase Partitioning*. Water Resour. Res., 23(10):1926-1938.
- Baehr, A.L., and Hult, M.F., 1991, Evaluation of unsaturated zone air permeability through pneumatic tests, Water Resour. Res., 27, 2605-2617.
- Baek, S.O., Y.S. Kim and R. Perry (1997). "Indoor Air Quality in Homes, Offices and Restaurants in Korean Urban Areas-Indoor/Outdoor Relationships", *Atmospheric Environment*, 31(4), 529-544.

---

References

- Barber, C., Davis, G.B., Briegel, D., and Ward, J.K., 1990, Factors controlling the concentration of methane and other volatiles in groundwater and soil gas around a waste site, *Journal of Contaminant Hydrology*, Vol. 5, pp. 155-169.
- Barone, F.S., R.K. Rowe, and R.M. Quigley. 1992. A laboratory estimation of diffusion and adsorption coefficients for several volatile organics in natural clay soil. *J. Contam. Hydrol.* 10:225–250.
- Batterman, S., I. Padmanabham, and P. Milne. 1996. *Effective Gas-Phase Diffusion Coefficients in Soils at Varying Water Content Measured Using a One-flow Sorbent-Based Technique.* *Env. Sci. Tech.*, 30:770-778.
- Berry-Spark, K., Ettinger, E., McAlary, T., DeFlaun, M., Finn, J., Lennon, J, and C. Sweeney, 2004. Vapor Intrusion at a Former Manufactured Gas Plant Site – Assessing Background Contributions to Indoor Air, Platform presentation at the Midwestern States Risk Assessment Symposium, Indianapolis, IN, August, 2004.
- Berry-Spark, K., McAlary, T., Bice, N. and M. DeFlaun, 2004. Empirical and Modeled Alpha Factors at Two Vapor Intrusion Sites, Platform Presentation at The Annual International Conference on Soils, Sediments and Water: Modeling Vapor Attenuation Workshop, October 18 – 19, 2004, University of Massachusetts at Amherst
- Bonanno, L.J. (2000). Household characteristics, activities and contamination: Exposure Assessment for children in the NHEXAS population, Ph.D. dissertation, Rutgers, the State University of New Jersey and University of Medicine and Dentistry of New Jersey.
- Boyer, J.E. (2003): Background contamination and its impact on the assessment of vapor intrusion. *Proceedings from the USEPA Seminars on Air Indoor Vapor Intrusion San Francisco, Dallas, & Atlanta*, January (<http://www.epa.gov/ttnrmrl/presentations.htm>).
- Bradley L.J.N., M. Garcia, K. Sullivan, J. Ferry (2004): Background Levels of Benzene in Indoor and Outdoor Air, *Proceedings: Natural Gas Technologies Conference*, Phoenix, AZ, February.
- British Petroleum (BP). 1998. SPP-110 Vadose Zone Sampling at BP Corrective Action Sites. Global Environmental Management, a BP Affiliated Company. Lisle IL.
- Brooks, R.H. and Corey. 1996. *Properties of Porous Media Affecting Fluid Flow.* ASCEJ. Irrig. Drainage Division. 72(IR2), 61-88.
- Brown, S.K., M.R. Sim, M.J. Abramson, and C.N. Gray (1994): Concentrations of volatile organic compounds in indoor air – a review. *Indoor Air*, 4: 123-134.
- Brown, V.M., H.S. Mann, and D.R. Crump. 1999. *Formaldehyde and VOC Levels in Homes in England.* In: The 8<sup>th</sup> International Conference on Indoor Air Quality and Climate, August 8-13, 1999.
- California Air Resources Board (12/2001): California Ambient Air Quality Data CD, 1980-2000.

- California Air Resources Board and California Department of Health Services (2003): *Environmental Health Conditions in California's Portable Classrooms*. A joint report submitted by California Air Resources Board and California Department of Health Services, Sacramento, CA, November ([http://www.arb.ca.gov/research/indoor/pcs/leg\\_rpt/leg\\_rpt.htm](http://www.arb.ca.gov/research/indoor/pcs/leg_rpt/leg_rpt.htm)).
- California Energy Commission. 2001. Manual for Compliance with the 2001 Energy Efficiency Standards (for Nonresidential Buildings, High-Rise Residential Buildings, and Hotels/Motels). Document No. P400-01-032. August 2001.
- California Environmental Protection Agency (CalEPA), 1999a. *Air Toxics Hot Spots Program Risk Assessment Guidelines: Part II. Technical Support Document for Describing Available Cancer Potency Factors*. Office of Environmental Health Hazard Assessment, Berkeley, CA. [http://www.oehha.org/air/cancer\\_guide/hzca2.html](http://www.oehha.org/air/cancer_guide/hzca2.html).
- California Environmental Protection Agency (CalEPA), 1999c. *Air Toxics Hot Spots Program Risk Assessment Guidelines: Part I. The Determination of Acute Reference Exposure Levels for Airborne Toxicants*. Office of Environmental Health Hazard Assessment, Berkeley, CA. [http://www.oehha.org/air/acute\\_rels/acuterel.html](http://www.oehha.org/air/acute_rels/acuterel.html).
- California Environmental Protection Agency (CalEPA), 2000. *Air Toxics Hot Spots Program Risk Assessment Guidelines: Part III. Technical Support Document for the Determination of Noncancer Chronic Reference Exposure Levels*. Office of Environmental Health Hazard Assessment, Berkeley, CA.
- [http://www.oehha.org/air/chronic\\_rels/22RELS2k.html](http://www.oehha.org/air/chronic_rels/22RELS2k.html),
- [http://www.oehha.org/air/chronic\\_rels/42kChREL.html](http://www.oehha.org/air/chronic_rels/42kChREL.html),
- [http://www.oehha.org/air/chronic\\_rels/Jan2001ChREL.html](http://www.oehha.org/air/chronic_rels/Jan2001ChREL.html), and
- [http://www.oehha.org/air/chronic\\_rels/1201Crels.html](http://www.oehha.org/air/chronic_rels/1201Crels.html).
- California Environmental Protection Agency (CalEPA), 2003. Advisory – Active Soil Gas Investigation. Jointly issued by the Regional Water Quality Control Board, Los Angeles Region and the Department of Toxic Substances Control. January 28, 2003. [[www.dtsc.ca.gov/PublicationsForms/index.html](http://www.dtsc.ca.gov/PublicationsForms/index.html)]
- California Department of Toxic Substances Control. 2004a. Advisory on Common Remedies for Methane in Subsurface Soils at School Sites, School Property Evaluation and Cleanup Division. California Environmental Protection Agency. November 2004.
- California Department of Toxic Substances Control (DTSC), 2004. Interim Final Guidance for the Evaluation and Mitigation of Subsurface Vapor Intrusion to Indoor Air, December 15, 2004.

---

References

- California Office of Environmental Health Hazard Assessment. 2004. Human-Exposure-Based Screening Numbers Developed to Aid Estimation of Cleanup Costs for Contaminated Soil. Integrated Risk Assessment Section. November 2004.
- Carrigan, C.R., S.A. Martins, A.L. Ramirez, W.D. Daily, G.B. Hudson, J.J. Nitao, B. Ekwurzel, and D. Ralston. 2000. *Characterization of Contaminant Transport by Gravity, Capillarity and Barometric Pumping in Heterogeneous Vadose Zones*. UCRL-ID-142784, Lawrence Livermore National Laboratory.
- Carrigan, C.R., G.B. Hudson, S.A. Martins, A.L. Ramirez, W.D. Daily, H.M. Buettner, J.J. Nitao, D. Ralston, B. Ekwurzel, J.E. Moran, and J.F. McCarthy. 1999. *Lessons About Transport and Monitoring at the Vadose Zone Observatory at LLNL*. UCRL-JC-133288-ABS, Lawrence Livermore National Laboratory, American Geophysical Union 1999 Spring Meeting, Boston, MA. May 31-June 4, 1999.
- Carrigan, C.R., G.B. Hudson, S. Martins, A.L. Ramirez, W.D. Daily, and H.M. Buettner. 1998. *Vadose zone observatory: dynamical characterization of liquid- and gas-phase contaminant transport in a heterogeneous soil regime*. UCRL-JC-131755-ABS, Lawrence Livermore National Laboratory, American Geophysical Union 1998 Fall Meeting, San Francisco, CA, December 6-10, 1998.
- Carsel, R.F. and R.S. Parrish. 1998. *Developing Joint Probability Distributions of Soil Water Retention Characteristics*. Water Resources Research. 24(5). 755-769.
- Charbeneau, R.J., 2000. Groundwater Hydraulics and Pollutant Transport. Prentice Hall, Upper Saddle River, NJ.
- Chen, C., Green, R.E., Thomas, D.M., and J.A. Knuteson, 1995. Environ. Sci. Technol. 29: 1816-1821.
- Chiou, C.T., and T.D. Shoup. 1985. *Soil Sorption of Organic Vapors and Effects of Humidity on Sorptive Mechanism and Capacity*. Env. Sci. Tech., 19:1196-1200.
- Clayton, C.A., E.D. Pellizzari, R.W. Whitmore, R.L. Perritt and J.J. Quackenboss (1999). "National Human Exposure Assessment Survey (NHEXAS): distributions and associations of lead, arsenic and volatile organic chemicals in EPA Region 5", *J. Exposure Anal. And Environ. Epidemiology*, **9**, 381-392.
- Clements, W.E., and M.H. Wilkening. 1974. Atmospheric pressure effects on <sup>222</sup>Rn transport across the earth-air interface. J. Geophys. Res. 79:6025-6029.
- Cody R.J., Jennings, R. Willey, R., Mickunas, D. Zownir, A., Curran, R., and R. Mosley, 2002. Raymark Industries: A Superfund Indoor Air Case Study. Platform Presentation at the Third International Conference on Remediation of Chlorinated and Recalcitrant Compounds, Monterey, California, May 20-23, 2002.

- Cohen, M.A., P.B. Ryan, Y. Yanagisawa, J.D. Spengler, H. Ozkaynak, and P. Epstein. 1989. Indoor /outdoor Measurements of Volatile Organic Compounds in the Kanawha Valley of West Virginia. *JAPCA*, 39:1086-1093.
- Collin, M., and A. Rasmuson. 1988. A comparison of gas diffusivity models for unsaturated porous media. *Soil Sci. Soc. Am. J.* 52:1559–1565.
- Conant, B.H., R.W. Gillham, and C.A. Mendoza. 1996. Vapor transport of trichloroethylene in the unsaturated zone: Field and numerical modeling investigations. *Water Resour. Res.* 32:9–22.
- Connor, J.A., Ahmad, F.A., and McHugh, T.E. 2001. “Development of Simple Screening Criteria for the Indoor Air Pathway.” API/NGWA Petroleum Hydrocarbons Conference. Houston, TX. November.
- Connor, J.A., McHugh, T.E., Ahmad, F.A., 2002 “Empirical Analysis of Groundwater-to-Indoor-Air Exposure Pathway Based on Measured Concentrations at Multiple Groundwater Impact Sites”, Proceedings of the 2002 Petroleum Hydrocarbons and Organic Chemicals in Ground Water: Prevention, Detection, and Remediation, Atlanta, Georgia, November 6-8, 2002.
- Connor, J.A., McHugh, T.E., 2003, “Practical Considerations for Addressing the Vapor Intrusion Pathway”, Presentation at the National RCRA Corrective Action Conference, New Orleans, LA, June 24-25, 2003.
- County of San Diego. 1998. *SAM Manual*. County of San Diego, Department of Environmental Health, Section 6, pg. B-31-53.
- County of San Diego, Department of Environmental Health (CSDDEH). 2002. Site Assessment and Mitigation Manual. San Diego, CA.
- CTDEP (Connecticut Department of Environmental Protection). June 12, 2000. *Appendix I. List of DRAFT Detailed Guidance Topics*. (Indoor Air Monitoring). Connecticut Department of Environmental Protection. Bureau of Water Management. Permitting, Enforcement and Remediation Division.
- Daisey, J.M., A.T. Hodgson, W.J. Fisk et al. (1994): Volatile organic compounds in twelve California office buildings: classes, concentrations and sources. *Atmospheric Environ.*, 28: 3557-3562.
- Davis, B. K., J. F. Beach, M. J. Wade, A. K. Klein, and K. Hoch. 2002. Risk Assessment of Polychlorinated Biphenyls (PCBs) in Indoor Air. *The Toxicologist*, Supplement to Toxicological Sciences 66:106. Abstract Number 516.
- Davis, B. K., and M.J. Wade. 2003. Risk Assessment of Polychlorinated Biphenyls at Hazardous Waste Sites. *The Toxicologist*, Supplement to Toxicological Sciences 72:394. Abstract Number 1912.

---

References

- Dawson, H.E. 2002. Reliability of screening level approaches for evaluating the vapor intrusion to indoor air pathway. Presentation at the 2002 RCRA National Meeting. Washington, DC.
- Dawson, H. 2004. Comments on Empirical Data / Methods. Presentation at the 14<sup>th</sup> Annual West Coast Conference on Soils, Sediments, and Water, Association of Environmental Health and Science; Vapor Intrusion Attenuation Workshop sponsored by the United States Environmental Protection Agency. San Diego, California. March 15 –18, 2004.
- Department of Environmental Quality. 1998. *Department of Environmental Quality Storage Tank Division Part 213, Risk-Based Screening Levels (RBSLs) for Groundwater and Soil Volatilization to Indoor Air*. Operational Memorandum No. 4, Attachment 8, June 12, 1998.
- DeVaull, G. E., R. A. Ettinger, and J. B. Gustafson, 2002. Chemical Vapor Intrusion from Soil or Groundwater to Indoor Air: Significance of Unsaturated Zone Biodegradation of Aromatic Hydrocarbons, Soil and Sediment Contamination, Vol. 11, No. 4, pp. 625-641.
- DeVaull, G. E., R. A. Ettinger, J. P. Salinitro, and J. B. Gustafson. 1997. "Benzene, Toluene, Ethylbenzene and Xylenes (BTEX) Degradation in Vadose Zone Soils During Vapor Transport: First Order Rate Constants." Proceedings of the API/NGWA Petroleum Hydrocarbons and Organic Chemicals in Groundwater: Prevention, Detection and Remediation Conference. Houston, TX. November 12-14. 365-379.
- De Visscher, A., D. Thomas, P. Boeckx, and O. Van Cleemput. 1999. "Methane Oxidation in Simulated Landfill Cover Soil Environments." *Environmental Science & Technology* 33: 1854-1859.
- Devitt, D.A., R.B. Evans, W.A. Jury, T.H. Starks, B. Eklund, and A. Gholson. 1987. Soil Gas Sensing for Detection and Mapping of Volatile Organics. EPA/600/8-87/036. US EPA-EMSL. Las Vegas, NV.
- DiPersio, T., J. Fitzgerald. 1995. *Guidelines for the Design, Installation, and Operation of Sub-Slab Depressurization Systems*. Massachusetts Department of Environmental Protection – Northeast Regional Office, pg. 1-15.
- Eaton, R.S. and A.G. Scott. 1984. *Understanding Radon Transport Into Houses*. Radiation Protection Dosimetry. 7. 251-253.
- Edwards, R.D., J. Jurvelin, K. Saarela and M. Jantunen (2001). "VOC concentrations measured in personal samples and residential indoor, outdoor and workplace microenvironments in EXPOLIS-Helsinki, Finland", *Atmospheric Environment*, **35**, 4531-4543.
- Eklund, B. 1985. Detection of Hydrocarbons in Groundwater by Analysis of Shallow Soil Gas/Vapor. American Petroleum Institute Publication No. 4394. May.
- Eklund, B. 1992. "Practical Guidance for Flux Chamber Measurements of Fugitive Volatile Organic Emission Rates." *Journal of the Air & Waste Management Association* 42(12): 1583-92.

- Ekwurzel, B., G.B. Hudson, J.E. Moran, C.R. Carrigan, S.A. Martins, and D.K. Ralston. 1999. *Deuterium, Br, I, and 18O used as tracers of infiltration water movement through the vadose zone*. UCRL-JC-133378-ABS, Lawrence Livermore National Laboratory. American Geophysical Union 1999 Spring Meeting, Boston, MA, May 31-June 4, 1999.
- El-Beshry, M., J.S. Gierke, and P.B. Bedient. 2000. *Modeling the Performance of an SVE Field Test*. In: *Vadose Zone Science and Technology Solutions, Volume II*: 1157-1169. Battelle Press, Columbus, OH.
- Ellerd, M.G., J.W. Massman, D.P. Schwaegler, V.J. Rohay. 1999. *Enhancements for Passive Vapor Extraction: The Hanford Study*. *Ground Water*, 37(3):427-437.
- Environment Agency (2002). The contaminated land exposure assessment model (CLEA): technical basis and algorithms. Environment Agency, R&D Publication CLR 10, Bristol, UK.
- Environment Agency (2002a). Assessment of risks to human health from land contamination: an overview of the development of soil guideline values and related research. Environment Agency, R&D Publication CLR 7, Bristol, UK.
- Environment Agency (2002b). Vapour transfer of soil contaminants. Environment Agency, R&D Technical report P5-018/TR, Bristol, UK.
- Environmental Quality Management, 2000. User's Guide for the Johnson and Ettinger (1991) Model for Subsurface Vapor Intrusion into Buildings. Prepared for U.S. EPA Office of Emergency and Remedial Response. Washington, DC. December.
- EPRI, 2002: Compendium of Air Quality Monitoring Methods for Manufactured Gas Plant Site Remediation, EPRI, Palo Alto, CA, 2002. [Product ID # 1005167].
- EPRI, 2003: Modeling Potential Vapor Intrusion Issues at a Manufactured Gas Plant Site , EPRI, Palo Alto, CA, 2003. [Product ID # 1009103].
- EPRI, 2004: Proceedings: A Workshop on Subsurface Vapor Intrusion to Indoor Air , EPRI, Palo Alto, CA, 2004. [Product ID # 1010916].
- EPRI, 2004: Proceedings: Comparison of Field Gas Chromatographs for Monitoring Manufactured Gas Plant Site Emissions, Odors, and Naphthalene, EPRI, Palo Alto, CA, 2004.
- EPRI, 2003: Comparison of Air Monitoring Techniques at an Manufacturing Gas Plant (MGP) Site, EPRI, Palo Alto, CA, 2003. [Product ID #1005512].
- EPRI, 2003: Tests of Odor and Emission Control Methods for Manufactured gas plant (MGP) Waste, EPRI, Palo Alto, CA, 2003. [Product ID #1008960].
- Ettinger, R.A., 2003. The Impact of Background Concentrations on Vapor Intrusion Assessment. Invited Platform Presentation at the California Groundwater Resources

---

References

Association Symposium "Subsurface Vapor Intrusion to Indoor Air: When is Soil and Groundwater Contamination and Indoor Air Issue?"

Falta, Ronald W., Iraj Javandel, Karsten Pruess, and Paul A. Witherspoon. 1989. *Density Driven Flow of Gas in the Unsaturated Zone Due to the Evaporation of Volatile Organic Compounds*. Water Resources Research, 25(10):2159-2169.

Farmer, W.J., Yang, M.S., Letey, J., and Spencer, W.F., 1980, Hexachlorobenzene: Its vapor pressure and vapor phase diffusion in soil, Soil Sci. Soc. Am. J., 44, 676-680.

Fellin, P.; Otson, R. The Effectiveness of Selected Materials in Moderation of Indoor VOC Levels. In Volatile Organic Compounds in the Environment; Wang, W., Schnoor, J., Doi, J., Eds.; ASTM STP 1261; American Society for Testing and Materials: West Conshohocken, PA, 1996; pp 135-146.

Ferguson, C.C., V.V. Krylov, and P.T. McGrath. 1995. *Contamination of Indoor Air by Toxic Soil Vapors: a Screening Risk Assessment Model*. Building and Environment, 30(3):375-383.

Ferguson C, Nathanail P, McCaffrey C, Earl N, Foster N, Gillett A and Ogden R. Method for deriving site-specific human health assessment criteria for contaminants in soil. SNIFFER report No. LQ01, Edinburgh, 2003.

Fischer, D., C.G. Urchin. 1996. *Laboratory Simulation of VOC Entry into Residence Basements from Soil Gas*. Env. Sci. Technol., 30(8):2598-2603.

Fischer, M.L., A.J. Bentley, K.A. Dunkin, A.T. Hodgson, W.W. Nazaroff, R.G. Sextro, and J.M. Daisey. 1996. *Factors Affecting Indoor Air Concentrations of Volatile Organic Compounds at a Site of Subsurface Gasoline Contamination*. Environ. Sci. Technol., 30(10): 2948-2957.

Fischer, J.M., Baker, R.J., and Baehr, A.L., Determination of vapor-phase diffusion coefficients for unsaturated-zone sediments at Galloway-Township, New Jersey, in U.S. Geological Survey Toxic Substances Hydrology Program – Proceedings of the Technical Meeting, Colorado Springs, Colorado, September 20-24, 1993, edited by D.W. Morganwalp and D.A. Aronson, U.S. Geol. Surv. Water Resour. Invest. Rep. 94-4015, 1996.

Fisher, L.J., L.M. Abriola, R.H. Kummler, D.T. Long, and K.G. Harrison. 2001. Evaluation of the Michigan Department of Environmental Quality's Generic Groundwater and Soil Volatilization to Indoor Air Inhalation Criteria. Michigan Environmental Science Board. Lansing, MI. May.

Fitzpatrick, N.A., and J.J. Fitzgerald. 1996. *An Evaluation of Vapor Intrusion Into Buildings Through a Study of Field Data*. Presented at the 11<sup>th</sup> Annual Conference on Contaminated Soils, University of Massachusetts at Amherst, October 1996. pp 1-15



- Folkes, D., 2000. Vapor Intrusion Assessment and Mitigation – Practical Issues and Lessons Learned. Platform Presentation at the RCRA National Meeting EI Forum, August 16, 2000, Washington, D.C. <http://www.clu-in.org/eiforum2000/agenda.cfm>
- Foster, S.J., J.P. Kurtz, and A.K. Woodland (2002): Background indoor air risks at selected residences in Denver, Colorado. *Proceedings: International Conference on Indoor Air*, Monterey, CA.
- Fugler, D., and M. Adomait. 1997. *Indoor Infiltration of Volatile Organic Contaminants: Measured Soil Gas Entry Rates and Other Research Results for Canadian Houses*. *Journal of Soil Contamination*, 6(1):9-13.
- Garbesi, K., and R.G. Sextro, 1989. *Modeling and Field Evidence of Pressure-Driven Entry of Soil Gas into a House through Permeable Below-Grade Walls*. *Environ. Sci. Technol.*, 23(12):1481-1487.
- Garbesi, K., R.G. Sextro, W.J. Fisk, M.P. Modera, and K.L. Revzan. 1993. "Soil-Gas Entry into an Experimental Basement: Model Measurement Comparisons and Seasonal Effects." *Environmental Science & Technology*. 27(3): 466-473.
- Gelhar, L.W., A. Montaglou, C. Welty, and K.R. Rehfeldt. 1985. A review of field-scale physical solute transport processes in unsaturated and unsaturated porous media. EPRI, EA-4190, Research Project 2485-5, Palo Alto, CA.
- Gilbert, R.O., 1987. *Statistical Methods for Environmental Pollution Monitoring*. Van Nostrand Reinhold, New York. ISBN 0-442-23050-8. 320 pp.
- Girman, J. (2000). BASE (Building Assessment Survey and Evaluation): Indoor Air in Typical Environments. Presented at the RCRA Corrective Action EI Forum, August 15, 2000, Washington DC.
- Girman, J.R., G.E. Hadwen, L.E. Burton, S.E. Womble, and J.F. McCarthy. 1999. *Individual Volatile Organic Compound Prevalence and Concentrations in 56 Buildings of the Building Assessment Survey and Evaluation (Base) Study*. In: *The 8<sup>th</sup> International Conference on Indoor Air Quality and Climate*, August 8-13, 1999.
- Grimsrud, D.T., M.H. Sherman, and R.C. Sonderegger. 1983. Calculating infiltration: implications for a construction quality standard. In: *Proceedings of the American Society of Heating, Refrigeration, and Air Conditioning Engineers Conference, Thermal Performance of Exterior Envelopes of Buildings II*. ASHRAE SP38, p. 422-452. Atlanta, GA.
- Gordon, S.M., P.J. Callahan, M.G. Nishioka, M.C. Brinkman, M.K. O'Rourke, M.D. Lebowitz and D.J. Moschandreas (1999). "Residential environmental measurements in the National Human Exposure Assessment survey (NHEXAS) pilot study in Arizona: preliminary results for pesticides and VOCs", *J. Exposure Anal. And Environ. Epidemiology*, 9, 456-470.

---

References

- Gu, T. 1982. *The Application of BET-type Equations to Adsorption from Mixed Vapors of Miscible Liquids*. J. Coll. Int. Sci., 88:599-601.
- Gustafsson, H. Building Materials Identified as Major Sources for Indoor Air Pollutants: A Critical Review of Case Studies; Report D10; Swedish Council for Building Research: 1992.
- Hartman, B. 2002. "How to Collect Reliable Soil-Gas Data for Risk-Based Applications, Part 1: Active Soil-Gas Method." LUST Line Bulletin 42. October.
- Hartman, B. 2003. "How to Collect Reliable Soil-Gas Data for Upward Risk Assessments, Part 2: Surface Flux Chamber Method." LUST Line Bulletin 44. August.
- Hartman, B. 2004. Email communication from B. Hartman, HP Labs to H. Hopkins, API. June 3.
- Health Canada, 2004. Final Draft Report on Soil Vapour Intrusion Guidance for Health Canada Screening Level Risk Assessment (SLRA), Golder Associates Ltd. October 2004.
- Helsel, Dennis R. 1990. *Less than Obvious*. Env. Sci. Tech., 24(12):1766-1774.
- Hers, Ian, Reidar Zapf-Gilje, Dyfed Evans, and Loretta Li. 1999. *Comparison, Validation and Use of Models for Predicting Indoor Air Quality from Soil and Groundwater Contamination*. Accepted for publication AEHS Journal of Soil and Contamination, June 2001.
- Hers, I., R. Zapf-Gilje, L. Li., and J. Atwater. 2000. "Validation of Models Used to Predict Indoor Air Quality from Soil and Groundwater Contamination." Proceedings of the API/NGWA Petroleum Hydrocarbons and Organic Chemicals in Groundwater: Prevention, Detection and Remediation Conference. Anaheim, CA, November 15-17. 213.
- Hers, I., R. Zapf-Gilje, L. Li, and J. Atwater. 2001. The Use of Indoor Air Measurements to Evaluate Intrusion of Subsurface VOC Vapours into Buildings. J. Air & Waste Manage. Assoc.. 51. 1318-1331.
- Hers, I., J. Atwater, L. Li., and R. Zapf-Gilje. 2001. "Evaluation of Vadose Zone Biodegradation of BTX Vapours." Journal of Contaminant Hydrology. V. 46, No.3-4, pp.233-264.
- Hers, I, R. Zapf-Gilje, P.C. Johnson, and L. Li. 2003. "Evaluation of the Johnson and Ettinger Model for Prediction of Indoor Air Quality." Ground Water Monitoring & Remediation 23(2): 119-133. NGWA, Westerville OH.
- Hewitt, A. D. 1994. Losses of Trichloroethylene From Soil During Sample Collection, Storage and Laboratory Handling. U. S. Army Corps of Engineers, Cold Regions Research and Engineering Laboratory. Special Report 94-8.
- Hewitt, A. D. 1999. Storage and Preservation of Soil Samples for Volatile Compound Analysis. U. S. Army Corps of Engineers, Cold Regions Research and Engineering Laboratory. Special Report 99-5.

- Hill, T.L. 1946a. *Theory of Multimolecular Adsorption from a Mixture of Gases*. J. Chem. Phys., 14:46-47.
- Hill, T.L. 1946b. *Statistical Mechanics of Multimolecular Adsorption: I*. J. Chem. Phys., 14:263-275.
- Hill, T.L. 1946c. *Theory of Multimolecular Adsorption from a Mixture of Gases*. J. Chem. Phys., 14:268-275.
- Ho, C.K. 2000. *Scale-Dependent Mass Transfer During SVE*. In: *Vadose Zone Science and Technology Solutions, Volume II*: 1170-1176. Battelle Press, Columbus, OH.
- Hodgson, A.T., K. Garbesi, R.G. Sextro, and J.M. Daisey. 1988. *Evaluation of Soil-Gas Transport of Organic Chemicals into Residential Buildings: Final Report*. Prepared for U.S. Department of Energy. Contract No. DE-AC03-76SF00098. Indoor Environment Program, University of California, Berkeley, CA.
- Hodgson, Alfred T. and Girman, John R.. March, 1989. "Application of a Multisorbent Sampling Technique for Investigations of Volatile Organic Compounds in Buildings" in *Design and Protocol for Monitoring Indoor Air Quality*. 1988. Nagda, N.L. and J.P. Harper, Eds. American Society for Testing and Materials. Philadelphia. pp. 246.
- Hodgson, A.T., K. Garbesi, R.G. Sextro, and J.M. Daisey. 1992. *Soil-Gas Contamination and Entry of Volatile Organic Compounds into a House Near a Landfill*. Journal of the Air and Waste Management Association, 42(3):277-283.
- Hoff, J.T., R. Gillham, D. Mackay, and W.Y. Shiu. 1993. *Sorption of Organic Vapors at the Air-Water Interface in a Sandy Aquifer Material*. Env. Sci. Tech., 27(13):2789-2794.
- Howard-Reed, C., Wallace, L.A., and W. R. Ott, 2002. The Effect of Opening Windows on Air Change Rates in Two Homes, ISSN 1047-3289 *J. Air & Waste Manage. Assoc.* 52:147-159
- Hughes, B.M., R.W. Gillham, and C.A. Mendoza. 1990. *Transport of Trichloroethylene Vapours in the Unsaturated Zone: A Field Experiment*. Proceedings, IAH Conference on Subsurface Contamination by Immiscible Fluids, Calgary, April 18-20.
- Huntington Beach Methane Codes (HBMC). 2003. City Specification No. 429 – Methane District Building Permit Requirements. Reference to HBMC Section 17.04.085. Huntington Beach, CA. Draft.
- Hutcheson, Michael S., D. Pederson, N.D. Anastas, J. Fitzgerald, and D. Silverman. 1996. *beyond TPH: Health-Based Evaluation of Petroleum Hydrocarbon Exposures*. Regulatory Toxicology and Pharmacology, 24:85-101.
- Interstate Technology and Regulatory Council (ITRC), 2004. *Technical and Regulatory Guidance for Using Polyethylene Diffusion Bag Samplers to Monitor Volatile Organic*

---

References

- Compounds in Groundwater; Technical/Regulatory Guidelines. Diffusion Sampler Team. February 2004.
- Interstate Technology and Regulatory Council (ITRC), 2003. Vapor Intrusion Issues at Brownfield Sites. [www.itrcweb.org](http://www.itrcweb.org).
- Jantunen, M.J., O. Hänninen, K. Katsouyanni, H. Knöppel, N. Kuenzli, E. Lebret, M. Maroni, K. Saarela, R. Srám and D. Zmirou (draft report). Final Report: Air Pollution Exposure in European Cities: the "EXPOLIS" Study.
- Jeng, C.Y., V.J. Kremsec, Jr., and H.S. Primack. 1996. *Models of Hydrocarbon Vapor Diffusion Through Soil and transport into Buildings*. Proc. 1996 Petrol. Hydro. and Org. Chem. In Ground Water. API/NGWA, Houston, Texas, November 13-15, 319-338.
- Jin, Y., T. Strech, and W. A. Jury, 1994. Transport and Biodegradation of Toluene in Unsaturated Soil, *Journal of Contaminant Hydrology*, v17, pp 111-127.
- Johnson, P.C., and R.A. Ettinger. 1991. *Heuristic Model for Predicting the Intrusion Rate of Contaminant Vapors into Buildings*. *Environ. Sci. Technol.*, 25:1445-1452.
- Johnson, P.C., M.W. Kemblowski, and J.D. Colthart. 1990. *Quantitative Analysis for the Cleanup of Hydrocarbon-Contaminated Soils by In-situ Soil Venting*. *Ground Water*, 28(3):413-429.
- Johnson, P.C., Mariush W. Kemblowski, and Richard L. Johnson. 1999. *Assessing the Significance of Subsurface Contaminant Vapor Migration to Enclosed Spaces: Site-Specific Alternatives to Generic Estimates*. *Journal of Soil Contamination*, 8(3):389-421.
- Johnson, P.C., C. Bruce, R.L. Johnson, and M.W. Kemblowski. 1998. *In Situ Measurement of Effective Vapour-Phase Porous Medium Diffusion Coefficients*. *Environmental Science and Technology*. 32. 3405-3409.
- Johnson, P. C and L. Abreu. 2003. Confusion? Delusion? What Do We Really Know About Vapor Intrusion. Groundwater Resources Association Symposium on Groundwater Contaminants; Subsurface Vapor Intrusion to Indoor Air: When Is Soil and Groundwater Contamination an Indoor Air Issue? September 30, 2003 (San Jose) and October 1, 2003 (Long Beach).
- Johnson, P.C., R.A. Ettinger, J. Kurtz, R. Bryan, and J.E. Kester. 2002a. Migration of Soil gas Vapours to Indoor Air: Determining Vapour Attenuation Factors Using a Screening-Level model and Field Data from the CDOT-MTL Denver, Colorado Site. *American Institute Bulletin No. 16*. April.
- Johnson, P.C., V.A. Hermes, S. Roggemans. 2002b. An Oxygen-Limited Hydrocarbon Vapour Migration Attenuation Screening Model. In Preparation.

- Johnson, P.C. 2002. "Sensitivity Analysis and Identification of Critical and Non-Critical Parameters for the Johnson and Ettinger (1991) Vapor Intrusion Model." API Soil and Groundwater Research Bulletin No. 17. API. May.
- Johnson, P.C., P. Lundegard, J. Catts, K. DiSimone, D. Eley, and K. Schroeder. 2003. Source Zone Natural Attenuation Field Measurements, Data Interpretation, and Data Reduction at the Former Guadalupe Oil Field, San Luis Obispo County, California.
- Johnson, R. L., McCarthy, K. A., Perrott, M. and C.A. Mendoza, 1990. Density-Driven Vapor Transport: Physical and Numerical Modeling. IAH Conference on Immiscible Fluids in Porous Media, Calgary, Alberta, Canada, April 1990.
- Johnson, R.L., K.A. McCarthy, M. Perrott, and C.A. Mendoza. 1990. *Density-Driven Vapor Transport: Physical and Numerical Modeling*. Presented at the IAH Conference on Immiscible fluids in Porous Media, Calgary, Alberta, Canada, April, 1990.
- Joss, C.J., and A.L. Baehr, 1995. Documentation of AIR3D, An Adaptation of the Ground-Water-Flow Code MODFLOW to Simulate Three-Dimensional Air Flow in the Unsaturated Zone. U.S. Geol. Survey Open-File Rep. 94-533.
- Jury, William A., David Russo, Gary Stereile, and Hesham El Abd. 1990. *Evaluation of Volatilization by Organic Chemicals Residing Below the Soil Surface*. Water Resources Research, 26(1):13-20.
- Jury, W.A., W.J. Farmer, and W.F. Spencer. 1984. *Behaviour Assessment Model for Trace Organics in Soil: II. Chemical Classification and Parameter Sensitivity*. J. Environ. Qual., 13(4):567-572.
- Jury, W.A., W.J. Farmer, and W.F. Spencer. 1984. *Behaviour Assessment Model for Trace Organics in Soil: IV. Review of Experimental Evidence*. J. Environ. Qual., 13(4):580-586.
- Kaplan, I.R., Galperin, Y., Lu, S. and R. Lee, 1997. Forensic Environmental Geochemistry: differentiation of fuel-types, their sources and release time, Org. Geochem. Vol. 27, No. 5/6, pp. 289-317.
- Kelly et al. (1994): *Environ. Sci. Technol.*, 28(8): 378A-387A.
- Kerfoot, H.B., Mayer, C.L., Durgin, P.B., and D'Lugosz, J.J., 1988, Measurement of carbon dioxide in soil gases for indication of subsurface hydrocarbon contamination, Ground Water Monitoring Review, 8, 67-70.
- Kerfoot H.B., "Is Soil-Gas Analysis an Effective Means of Tracking Contaminant Plumes in Ground Water? What are the Limitations of the Technology Currently Employed?", Invited Position Paper, *Ground Water Monitoring Review*, Spring, 1988.
- Kerfoot, H.B., "Subsurface Partitioning of Volatile Organic Compounds: Effects of Temperature and Soil Moisture", *Ground Water*, 29(5):678-684, June/July 1991.

---

References

- Kerfoot, H.B.; S. L. Pierett; E. N. Amick; D. W. Bottrell; J. D. Petty, "Analytical Performance of Four Portable Gas Chromatographs Under Field Conditions", *Journal of the Air Pollution Control Association*, 40(8) 1106-1113, August, 1990.
- Kerfoot, H.B., "Soil-Gas Surveys for Detection and Delineation of Ground-Water Contamination", *Invited Paper, Trends in Analytical Chemistry*, April, 1990.
- Kerfoot, H.B. and M. J. Miah, "Spatial Resolution of Ground-Water Contamination by Soil-Gas Measurement", *Chemometrics and Intelligent Laboratory Systems*, 1987.
- Kerfoot, H.B., "Shallow-Probe Soil-Gas Sampling for Indication of Ground-Water Contamination by Chloroform", *International Journal of Environmental Analytical Chemistry*, 30, 167-181, 1987.
- Kerfoot, H.B., "Shallow-Probe Soil-Gas Sampling for Detection of Ground-Water Contamination by Volatile Organic Compounds", *Environmental Science and Technology*, October, 1987.
- Kerfoot, H.B., and M.J. Miah, "Network Design in Soil-Gas Surveys", *EOS*, (16), 1987, pg. 322.
- Kimbell, B.A., and D.E. Lemon. 1972. Theory of soil air movement due to pressure fluctuations. *Agric. Meteorol.* 9:163-181.
- Kindziarski, W.B. 1997. "Influence of Soil Gas Entry, Outdoor and Indoor Sources on Indoor VOCs at Petroleum Contaminated Settings." Proceedings of the Air and Waste Management Conference. Toronto, Ontario, Canada. June 8-13.
- Koontz, M.D. and H.E. Rector. 1995. *Estimation of Distributions for Residential Air Exchange Rates*. EPA Contract No. 68-D9-0166, Work Assignment No. 3-19. USEPA Office of Pollution Prevention and Toxics. Washington, D.C.
- Kostianen, R. (1995). "Volatile Organic Compounds in the Indoor Air of Normal and Sick Houses", *Atmospheric Environment*, **29**(6), 693-702.
- Kramer, W.H. 1998. "Evaluation of Subsurface Utilities and Indoor Air Environments as Migration Pathways and Points of Exposure in a RBCA Site Assessment." Proceedings of the API/NGWA Petroleum Hydrocarbons and Organic Chemicals in Groundwater: Prevention, Detection and Remediation Conference. Houston, TX. November 12-14. 267-298.
- Kreamer, D.K., Weeks, E. P., and Thompson, G.M., 1988, A field technique to measure the tortuosity and sorption-affected porosity for gaseous diffusion of materials in the unsaturated zone with experimental results from near Barnwell, South Carolina, *Water Resour. Res.*, 24, 331-341.
- Krylov, V.V., and C.C. Ferguson. 1998. *Contamination of Indoor Air by Toxic Soil Vapours: The Effects of Subfloor Ventilation and Other Protective Measures*. *Building and Environment*. 33(6), 331-347.

- Kurtz, J.P. and D.J. Folkes (2002): Background concentrations of selected chlorinated hydrocarbons in residential indoor air. *Proceedings: International Conference on Indoor Air*, Monterey, California.
- Kurz, D.W. 2000. Estimating residential indoor air impacts due to groundwater contamination. in: *Proceedings of the 2000 Conference on Hazardous Waste Research*.
- Lai, S.H., J.M. Tiedje, and A.E. Ericson. 1976. In situ measurement of gas diffusion coefficient in soils. *Soil Sci. Soc. Am. J.* 40:3–6.
- Laubacher, R.C., P. Bartholomae, P. Velasco, and H.J. Reisinger. 1997. *An Evaluation of the Vapor Profile in the Vadose Zone Above a Gasoline Plume*. Proc. 1997 Petrol. Hydro and Org. Chem. In Groundwater. API/NWGA, Houston, Texas, pp. 396-409.
- Lahvis, M.A. 2002. Guidance on Use of Soil-Gas Surveys to Assess Vapor Transport to Indoor Air. Shell Global Solutions (U.S.), Inc. Houston, TX.
- Lahvis, M.A., 2003. Evaluation of Small-Volume Releases of Ethanol-Blended Gasoline at UST Sites, API Technical Bulletin, #19.
- Lahvis, M.A., and A.L. Baehr, 1996, Estimation of rates of aerobic hydrocarbon biodegradation by simulation of gas transport in the unsaturated zone, *Water Resour. Res.*, 32, 2231-2249.
- Lahvis, M.A., and A.L. Baehr, 1997, Documentation of R-UNSAT, a computer model for the simulation of reactive, multispecies transport in the unsaturated zone, U.S. Geological Survey Open-File Report 97-630, 104 pp.
- Lahvis, M.A., A.L. Baehr and R.J. Baker, 1999. Quantification of Aerobic Biodegradation and Volatilization rates of Gasoline Hydrocarbons Near the Water Table Under Natural Attenuation Conditions, *Water Resources Research*, v35, no 3, pp 753-765.
- Lamb, B.; Westberg, H.; Byrant, P.; Dean, J.; Mullins, S., 1985. Air Infiltration Rates in Pre- and Post-Weatherized Houses; *J. Air Pollut. Control Assoc.* V 35, 545-551.
- Lee, S.C., W.M. Li and C.H. Ao, 2002. "Investigation of indoor air quality at residential homes in Hong Kong - case study", *Atmospheric Environment*, **36**, 225-237.
- Leeson, A., and R.E. Hinchee, 1997. *Soil Bioventing, Principals and Practice*. Lewis Publishers.
- Lewis, C.W.; Zwiedinger, R.B. Apportionment of Residential Indoor Aerosol, VOC and Aldehyde Sources, and their Source Strengths; *Atmos. Environ.* 1990, 26A (12), 2179-2184.
- Lewis, M.A., and A.L. Baehr, 1996. Estimation of Rates of Hydrocarbon Biodegradation by Simulation of Gas Transport in the Unsaturated Zone, *Water Resour. J.* 32:2231-2249.
- Lewis R.J., Sr. (Revised by) 2001. *Hawley's Condensed Chemical Dictionary*, 14th Edition. New York: John Wiley & Sons, Inc.

---

References

- Liao, H., D. Fischer, C.G. Urchin. *Mathematical Modeling of Pollutant Vapor Intrusion From Contaminated Soil and Ground Water Into Basements*.
- Lindmark, A., and B. Rosen. 1985. Radon in Soil Gas-Exhalation Tests, In Situ Measurements. *The Science of the Total Environment*, v. 45, p. 397 - 404.
- Little, J.C., J.M. Daisey, and W.W. Nazaroff. 1992. *Transport of Subsurface Contaminants into Buildings: An Exposure Pathway for Volatile Organics*. *Env. Sci. Technol.*, 26(11):2058-2066.
- Los Angeles Methane Codes (LAMC). 1996. "High Potential Methane Zone Requirements." City Building Regulations Section 91.7104. Los Angeles, CA.
- Loureiro, C.O., L.M. Abriola, J.E. Martin, and R.G. Sextro. 1990. Three-dimensional simulation of radon transport into houses with basements under constant negative pressure. *Environ. Sci. Technol.* 24:1338-1348.
- Lowell, P.S., B. Eklund. 2004. VOC Emission Fluxes as a Function of Lateral Distance from the Source. American Institute of Chemical Engineers: Environmental Progress, v23 no.1, pp. 52-58. Published online in Wiley InterScience ([www.interscience.wiley.com](http://www.interscience.wiley.com)). DOI 10.1002/ep.10007
- Mackay, D. 1991. *Multimedia Environmental Models*. Lewis Publishers, Chelsea, MI.
- Malander, M. and Novick, N. 2003. Process of Evaluation of Vapor Intrusion to Indoor Air at Corrective Action Sites (collection of 18 posters). Global Remediation, Fairfax, Va. May.
- MADEP (Massachusetts Department of Environmental Protection). 1989. *Summary Report, DEP Investigations at the Hillside School, Needham, MA*. NE Regional Office, Woburn, MA. 20 pgs.
- MADEP (Massachusetts Department of Environmental Protection). May 1990. *The Chemical Health Effects Assessment Methodology and the Method to Derive allowable Ambient Limits (CHEM/AAL)*. Office of Research and Standards.
- MADEP (Massachusetts Department of Environmental Protection). 1991a. *Policy for the Investigation, Assessment, and Remediation of Petroleum Releases: Interim Site Investigation Protocol Document*. DEP Publication #WSC-401-91.
- MADEP (Massachusetts Department of Environmental Protection). 1991b. *Methodology to Derive Indoor Air Guidance Levels*. Massachusetts Department of Environmental Protection. Office of Research and Standards. Boston, MA.
- MADEP (Massachusetts Department of Environmental Protection). August 1994a. *Interim Final Petroleum Report: Development of Health-Based Alternative to the Total Petroleum Hydrocarbon (TPH) Parameter*. Office of Research and Standards, MADEP and ABB Environmental Services, Inc.



- MADEP (Massachusetts Department of Environmental Protection), 1994b: *Background Documentation for the Development of MCP Numerical Standards*. Massachusetts Department of Environmental Protection, August.
- MADEP (Massachusetts Department of Environmental Protection). 1995b. Guidelines for the Design, Installation and Operation of Sub-Slab Depressurization Systems. Prepared by Thomas Dipersio and John Fitzgerald, Northeast Regional Office.
- MADEP. 2002. Indoor Air Sampling and Evaluation Guide. WSC Policy No. 02-430. Commonwealth of Massachusetts. Boston. MA. April.
- Mann, C.S. 1999. *Indoor Air Modeling for the Palermo Well Field Superfund Site*. Memorandum Prepared by Environmental Quality Management, Durham, NC, for U.S. EPA Contract 68D70002, WA No. 2-23. April 14.
- Mann, C. S. and D. Holoman, 2000. A Four-Phase Model for Estimating Subsurface Vapor Intrusion into Buildings, 93rd Annual Conference of the Air and Waste Management Association, 2000.
- Marrin, D.L., and H. B. Kerfoot, 1988. "Soil-Gas Surveys", Feature Article, *Environmental Science and Technology*, August, 1988.
- Mallon, B.J., S. Martins, and J.S. Johnson. 1996. *Tritiated water movement in an asphalt-covered vadose zone*. UCRL-JC-124647, Lawrence Livermore National Laboratory. Livermore.
- Mallon, B., S. Martins, J. Shinn, and J. Nitao. 1992. *Detailed Study of a Small Area can be Applied to the Water Movement Patterns of a Larger Site in the Vadose Zone*. UCRL-JC-110591abs. The Third Technology Information Exchange (TIE) Workshop, Pleasanton, CA, November 17-19, 1992.
- Massmann, J., and D.F. Farrier. 1992. *Effects of Atmospheric Pressures on Gas Transport in the Vadose Zone*. *Water Resources Research*, 28(3):777-791.
- Mayer, C.L., 1989, Draft interim guidance document for soil-gas surveying, U.S. Environmental Protection Agency Environmental Monitoring Systems Laboratory, Office of Research and Development, Contract Number 68-03-3245, 124 pp.
- McAlary, T.A., Berry-Spark, K., Krug, T. A., and J.M. Uruskyj, 2004. "The Fresh Water Lens and it's Effects on Groundwater to Indoor Air Attenuation Coefficients", a poster presentation at the US EPA Vapor Intrusion Workshop held at the AEHS 14<sup>th</sup> Annual West Coast Conference on Soils, Sediment and Water, San Diego, March 15-18, 2004.
- McAlary, T.A., P. Dollar, P. de Haven, R. Moss, G. Wilkinson, J. Llewellyn, and D. Crump, 2002. Assessment of Subsurface Vapour Transport Through Triassic Sandstone and Quarry Fill into Indoor Air in Weston Village, Runcorn Platform Presentation, Indoor Air 2002, Monterey, CA, July 1-5, 2002.

---

References

- McAlary, T.A. 1989. *Comparison of Measured and Calculated Reactive Vapor Diffusion Coefficients in Unsaturated Sands*. M.Sc. Thesis, Department of Earth Sciences, University of Waterloo, Waterloo, Ontario, Canada.
- McCarthy, K.A., and R.L. Johnson. 1991. *The Transport of Volatile Organic compounds across the Capillary Fringe*. Draft. Submitted to Water Resources Research, January 9, 1991.
- McCarthy, K.A., and R.L. Johnson. 1995. *Measurement of Trichloroethylene Diffusion as a Function of Moisture Content in sections of Gravity-Drained Soil Columns*. J. Environ. Qual., 24:49-55.
- McDonald, M.G., and A.W. Harbaugh. 1988. *A Modular Three-Dimensional Ground-water Flow Model*. U.S. Geological Survey techniques of Water-Resources Investigations, bk. 6, ch. A1, p. 548.
- McDonald, G. (2003): Presentation at the August 2003 RCRA National Meeting, Washington, DC. Air and Waste Management Association (AWMA).
- McHugh, T.E., P.C. de Blanc, and J.A. Connor. 2002. A Groundwater Mass Flux Model for Screening the Groundwater-to-Indoor Air Exposure Pathway in Risk Assessments. (Submitted for Publication.)
- McHugh, T.E. Connor, J.A. Ahmad, F. Newell, C.J. 2003a. "A Groundwater Mass Flux Model for Groundwater-to-Indoor-Air Vapor Intrusion." Submitted for the *Proceedings of the 7<sup>th</sup> International Symposium on In Situ and On-Site Bioremediation*. Orlando, Florida.
- Mendoza, Carl A. 1995. *Conceptual Models and Effective Transport Parameters for Long-term Vapour Transport in Heterogeneous Unsaturated Media*. Presented at: Solutions '95 IAH International Congress XXVI, June 5-9, 1995, Edmonton, Alberta.
- Mendoza, C.A., and E.O. Frind. 1990a. *Advective-Dispersive Transport of Dense Organic Vapors in the Unsaturated Zone I. Model Development*. Water Resources Research, 26(3):379-387.
- Mendoza, C.A., and E.O. Frind. 1990b. *Advective-Dispersive Transport of Dense Organic Vapours in the Unsaturated Zone II. Sensitivity Analysis*. Water Resources Research, 26(3):388-398.
- Mendoza, C.A., E.O. Frind, and B.M. Hughes. 1990. *Transport of Trichloroethylene Vapours in the Unsaturated Zone: Numerical Analysis of a Field Experiment*. Proceedings, IAH Conference on Subsurface Contamination by Immiscible Fluids, Calgary, April 18-20.
- Mendoza, C.A., E.O. Frind, and B.M. Hughes. 1990. *Vapor Transport of Organic Compounds: Simulation of Field Experiments and Model Validation*. In: IAHS International Conference on Calibration and Reliability in Groundwater Modelling, The Hague, September 1990.

- Mendoza, Carl A., and Todd A. McAlary. 1990. *Modeling of Ground-water Contamination Caused by Organic Solvent Vapors*. *Ground Water*, 28(2):199-206.
- MESB (Michigan Environmental Science Board). 2001. *Evaluation of the Michigan Department of Environmental Quality's Generic Groundwater and Soil Volatilization to Indoor Air Inhalation Criteria*. Lansing, MI. May.
- Millington, R. J., *Gas Diffusion in Porous Media*, Science, 1959, 130, 100-102.
- Millington, R. J. and R. C. Shearer. 1971. Diffusion in Aggregated Porous Media, *Soil Sci.* 111. 372-378.
- Millington, R.J. and J.P. Quirk. 1961. *Permeability of Porous Solids*, *Trans. Faraday Soc.* 57. 1200-1207.
- Mølhave, Lars. 1982. *Indoor Air Pollution Due to Organic Gases and Vapours of Solvents in Building Materials*. *Environment International*, 8:117-127.
- Mose, D.G. and G.W. Mushrush. 1999. Comparisons Between Soil Radon and Indoor Radon. *Energy Sources*. 21. 723-731.
- Mosley, R. B., *A Simple Model for Describing Radon Migration and Entry Into Houses*, 29th Handford Symposium, Richland, Washington, October 1990.
- Mosley, R. B., *Model Calculations of the Interaction of a Soil Depressurization System with the Radon Entry Process*, Proceedings of U.S. EPA Radon Symposium, Philadelphia, April 2-5 (1991).
- Moseley, C.L.; Meyer, M.R. Petroleum Contamination of an Elementary School: A Case History Involving Air, Soil-Gas and Groundwater Monitoring; *Environ. Sci. Technol.* 1992, 26, 185-192.
- Murray, D.M. and D.E. Burmaster. 1995. *Residential Air Exchange rates in the United States: Empirical and Estimated Parametric Distributions by Season and Climatic Region*. *Risk Analysis*. 15. 459-465.
- National Institute of Occupational Safety and Health (NIOSH), 1995. NTIS Publication No. PB-94-195047: Documentation for Immediately Dangerous to Life or Health Concentrations (IDLH): NIOSH Chemical Listing and Documentation of Revised IDLH Values (as of 3/1/95), <http://www.cdc.gov/niosh/idlh/intridl4.html>
- NAS (National Academy of Sciences). 1993. *Guidelines for Developing Community Emergency Exposure Levels for Hazardous Substances*. National Academy Press, Washington, DC.
- Nazaroff, W. W. 1985. Radon Entry Into Houses Having a Crawl Space. *Health Physics*, v. 48, n. 3, p. 265 – 281.

---

References

- Nazaroff, W.W. 1988. *Predicting the Rate of <sup>222</sup>Rn Entry from Soil into the Basement of a Dwelling Due to Pressure-Driven Air Flow*. *Radiation Protection Dosimetry*, 24:199-202.
- Nazaroff, W.W. 1988. Predicting the rate of <sup>222</sup>Rn entry from soil into the basement of a dwelling due to pressure-driven air flow. *Radiation Protection Dosimetry* 24:199-202.
- Nazaroff, W.W., Lewis, S.R., Doyle, S.M., Moed, B.A., and Nero, A.V., 1987, Experiments on pollutant transport from soil into residential basements by pressure-driven airflow, *Environ. Sci. Technol.*, 21, 459-466.
- Nazaroff, W.W. 1992. *Radon Transport from Soil to Air*. *Review of Geophysics*. 30 (2). 137-160.
- Nazaroff, W.W.; Feustel, H.; Nero, A.V.; Revzan, K.L.; Grimsrud, D.T.; Essling, M.A.; Toohey, R.E. Radon Transport into a Detached One-Story House with a Basement; *Atmos. Environ.* 1985, 19 (1), 31-46.
- Neeper, D.A. 2001. A model of oscillatory transport in granular soils, with application to barometric pumping and earth tides. *J. Contam. Hydrol.* 48:237–252.
- Nelson, D. W., and L. E. Sommers. 1982. Total Carbon, Organic Carbon, and Organic Matter. In: A. L. Page et al. (editors), *Methods of Soil Analysis: Part 2 Chemical and Microbiological Properties*. ASA [American Society of Agronomy, Inc.] Monograph Number 9, p. 539 – 579.
- New York State Department Of Health. 2001. *Indoor Air Sampling & Analysis Guidance*. New York State Department Of Health, Division Of Environmental Health Assessment, Bureau Of Toxic Substance Assessment. August 8, 2001.
- New York State Department of Health (2003): *Background Indoor/Outdoor Air Levels of Volatile Organic Compounds in Homes Sampled by the New York State Department of Health, 1989-1996, Interim Draft, January*.
- New York State Department of Health, 2005. *Endicott, New York, Environmental Investigations Vapor and Groundwater Sampling Results*  
<http://www.dec.state.ny.us/website/dshm/sldwaste/indicottsampling.htm>
- NHDES (New Hampshire Department of Environmental Services. October, 1998. “Residential Indoor Air Sampling Form.” Draft Residential Indoor Air Assessment Guidance Document. Waste Management Division. Site Remediation Programs.
- Nichols, Eric M., and John B. Gustafson. 1997. *Air Pathway Modeling for Risk-Based Corrective Action*. In: 7<sup>th</sup> Annual West Coast Conference on Contaminated Soils and Groundwater, March 11, 1997.
- Nielson, K., and V. Rogers. 1995. Project Summary, Feasibility of Characterizing Concealed Openings in the House-Soil Interface for Modeling Radon Gas Entry. United States

- Environmental Protection Agency, Air and Energy Engineering Research Laboratory. May 1995.
- Nilsen, R.H., E.W. Peterson, K.H. Lie, N.R. Burkhard, and J.R. Hears, 1991. Atmospheric pumping: A mechanisms causing vertical transport of contaminated gases through fractured permeable media. *J. Geophys. Res.* 96:21933–21948.
- NIOSH (National Institute for Occupational Safety and Health). 1997. *Pocket Guide to Chemical Hazards*. U.S. Department of Health and Human Services, Public Health Service, Centers for Disease Control and Prevention, Cincinnati, OH.
- NIOSH (National Institute for Occupational Safety and Health). 1995. *Documentation for immediately dangerous to life or health concentrations (IDLHs)*. NIOSH chemical listing and documentation of revised IDLH values. <http://www.cdc.gov/niosh/intridl4.html>
- Nitao, J., S.A. Martins, and M.N. Ridley. 2000. *Field Validation of the NUFT Code for Subsurface Remediation by Soil Vapor Extraction*. UCRL-ID-141546, Lawrence Livermore National Laboratory.
- NRC (National Research Council). 1986. *Criteria and methods for preparing emergency exposure guidance level (EEGL), short term public emergency guidance level (SPEGL) and continuous exposure guidance level (CEGL) documents*. Committee on Toxicology, National Academy Press, Washington, DC.
- NYSDOH (New York State Department of Health). 1997. “Indoor Air Quality Questionnaire and Building Inventory.” Division of Environmental Health Assessment. Bureau of Toxic Substance Assessment. WSC POLICY #02-430105
- Nye, P.H., Z. Gerstl, and Tz. Galin. 1994. *Soil Processes and Chemical Transport. Prediction of Sorption by Soils of Volatile Hydrocarbon Mixtures*. *J. Environ. Qual.*, 23:1031-1037.
- Occupational Safety and Health Administration (OSHA). 1998. Occupational Safety and Health Standards, Toxic and Hazardous Substances. *Code of Federal Regulations 29 CFR 1910.1000*.
- Ohura, T., T. Amagai, M. Fusaya, and H. Matsushita (2004): Polycyclic Aromatic Hydrocarbons in Indoor and Outdoor Environments and Factors Affecting Their Concentrations. *Environ. Sci. Technol.*, 38(1): 77-83.
- Olson, D.A. and R.L. Corsi. 2001. *Characterizing Exposure to Chemicals from Soil Vapour Intrusion Using Two-Compartment Model*. *Atmospheric Environment*. 35. 4201-4209.
- Olweny, M.R.O., T.J. Williamson, A. Delsante, et al. 1998. An Investigation of the Thermal Performance of Suspended Timber Floors. In: Proceedings of the 32<sup>nd</sup> Annual Australia and New Zealand Architectural Science Association Conference, Wellington, NZ. July 15-17, pp. 219-226.

---

References

- Oremland, R.S. and C.W. Culbertson. 1992. "Importance of Methane-Oxidizing Bacteria in the Methane Budget as Revealed by the Use of a Specific Inhibitor." *Nature* 356: 421-423. April.
- Ostendorf, David W., and Don H. Kampbell. 1991. Biodegradation of Hydrocarbon Vapors in the Unsaturated Zone. *Water Resources Research*, 27(4):453-462.
- Ostendorf, D.W., and D.H. Kampbell, 1990. Bioremediated Soil Venting of Light Hydrocarbons, *Hazardous Waste and Hazardous Materials*, v7, no 4, pp 319-334.
- Pandian, M.D.; Ott, W.R.; Fail, A. Residential Air Exchange for Use in Indoor Air and Exposure Modeling Studies; *J. Expos. Anal. Environ. Epidemiol.* 1993, 3, 407-416.
- Parker, G.B., M. McSorley, and J. Harris. 1990. The Northwest residential infiltration survey: a field study of ventilation of new houses in the Pacific Northwest. In: *Air Change Rate and Air Tightness in Buildings*. ASTM STP 1067. p. 93-103. American Society for Testing and Materials. Philadelphia, PA.
- Parker, J.C., 2003. Physical Processes Affecting the Natural Depletion of Volatile Organic Compounds in Soil and Groundwater, *Vadose Zone Journal*, 2:222-230 (2003)
- Parker, J.C. 2003. Modeling volatile chemical transport, biodecay and emission to indoor air. *Ground Water Monit. Rem.* Vol. 23 No.1, pp 107-120.
- Parmar, S.E. 1997. A Study of "Holding Times" for H<sub>2</sub>S, COS, and CH<sub>3</sub>SH Samples (Gas Phase) in Different Containers. ENSR Consulting and Engineering, pg. 1-7.
- Pateris, G., D. Werner, K. Kaufman, and P. Hohner, 2002. Vapor Phase Biodegradation of Volatile Fuel Compounds in the Unsaturated Zone: a Large-Scale Lysimeter Experiment. *Envi. Sci. Technol.* 36:30-39
- Paul, C. J., D. Digiulio, and R. Cody, 2003. "Vertical Profiling of Contaminants in Ground Water at the Raymark Superfund Site, Stratford, Connecticut", [http://www.epa.gov/ada/research/waste/research\\_06.pdf](http://www.epa.gov/ada/research/waste/research_06.pdf)
- Pennsylvania Department of Environmental Protection. 2002. Land Recycling Program Technical Guidance Manual. Section IV.A.4. "Vapor Intrusion into Buildings from Groundwater and Soil under the Act 2 Statewide Health Standard." 253-0300-100. Harrisburg PA. October. Draft.
- Peterson, E.W., K. Lie, and R.H. Nielson. 1987. Dispersion of contaminant during oscillatory gas-motion driven by atmospheric pressure variations. *In Proc. 4th Symp. on Containment of Underground Nuclear Explosions*. CONF-870961. Colorado Springs, CO.
- Posner, J.C., and W. J. Woodfin. 1986. Sampling with gas Bags I: Losses of Analyte with Time. *Appl. Ind. Hyg.*, 1(4):163-168.

- Puls, R.W., and Barcelona M.J., 1996. EPA Ground Water Issue Low-Flow (Minimal Drawdown) Ground-Water Sampling Procedures, EPA/540/S-95/504.
- Rago, R., R. McCafferty, and A. Rezendes (exp. 2005): *Background Levels of Volatile Organic Compounds (VOCs) and Air-Phase Petroleum Hydrocarbons (APH) in Massachusetts Residences*.
- Rago, R., R. McCafferty, and A. Rezendes (2004): *Background Residential Indoor Air Quality in Massachusetts*. Presentation, Vapor Intrusion Into Indoor Air Workshop, University of Massachusetts at Amherst, Conference on Soils, Sediments, and Water, Amherst, MA, October.
- Ralson, D.K., C.R. Carrigan, G.B. Hudson, S. Martins, and J.J. Nitao. 1999. Implications of modeling for gas-phase transport at the LLNL Vadose Zone Observatory. UCRL-JC-133289-ABS, Lawrence Livermore National Laboratory, American Geophysical Union 1999 Spring Meeting, Boston, MA, May 31-June 4, 1999.
- Ravi, V., and J.A. Johnson, 1997, VLEACH: A one-dimensional finite difference vadose-zone leaching model, U.S. Environmental Protection Agency Center for Subsurface Modeling Support, Ada, Oklahoma, 72 pp.
- Rezendes, A. (2004): *Vapor Intrusion Workshop: Analytical Methodology and Background Sources*. Presentation, Vapor Intrusion Into Indoor Air Workshop, University of Massachusetts at Amherst, Conference on Soils, Sediments, and Water, Amherst, MA, October.
- Rezvan, K.L., Fisk, W.J., Gadgil, A.J. 1991. "Modelling Radon Entry into Houses with Basements: Model Description and Verification" *Indoor Air*, 2, 173-189.
- Rhue, R.D., K.D. Pennell, P.S.C. Rao, and W.H. Reve. 1989. Competitive Adsorption of Alkylbenzenes and Water Vapors on Predominantly Mineral Surfaces. *Chemosphere*, 18:1971-1986.
- Rice, B., and J. Weinberg. 1994. Dressed To Kill. The dangers of dry cleaning and the case for chlorine-free alternatives. A Greenpeace/Pollution Probe Report. Prepared for Pollution Probe, Sunset Chemicals Project for the Great Lakes.
- Ririe, G. T., R.E. Sweeney, S.J. Daugherty. 2002. "A Comparison of Hydrocarbon Vapor Attenuation in the Field with Predictions from Vapor Diffusion Models." *Journal of Soil and Sediment Contamination* 11(4): 529-544.
- Ririe, T.; Sweeney, R., 1995. Fate and Transport of Volatile Hydrocarbons in the Vadose Zone. In Proceedings of 1995 Petrol. Hydro. and Org. Chem. in Ground Water; API/NGWA, Houston, TX, November 1995; pp 529-542.
- Rivett, M.O. 1995. Soil-gas Signatures from Volatile Chlorinated Solvents: Broden Field Experiments. *Ground Water*, 33(1):84-98.

---

References

- Robbins, G.A., Deyo, B.G., Temple, M.R., Stuart, J.D., and Lacy, M.J., 1990, Soil-gas surveying for subsurface gasoline contamination using total organic vapor detection instruments, Part I: Theory and laboratory experimentation, *Ground Water Monitoring Review*, 10, 122-131.
- Robinson, A.L., R.G. Sextro, W.J. Fisk. 1997. Soil-Gas Entry Into an Experimental Basement Driven by Atmospheric Pressure Fluctuations – Measurements, Spectral Analysis, and Model Comparison. *Atmospheric Environment*. 31 (10). 1477-1485.
- Robinson, A.L. and R.G. Sextro. 1997. Radon Entry into Buildings Driven by Atmospheric Pressure Fluctuations. *Environ. Science Technology*. 31 (6). 1742-1748.
- Roggemans, S., C.L. Bruce, P.C. Johnson, and R. L. Johnson. December 2001. *Vadose Zone Natural Attenuation of Hydrocarbon Vapors: An Empirical Assessment of Soil Gas Vertical Profile Data*. API Soil and Groundwater Technical Task Force Bulletin No. 15. American Petroleum Institute. Washington, DC.
- Roggemans, S., 1998. Natural Attenuation of Hydrocarbon vapors in the Unsaturated Zone, M.S. Thesis, Arizona State University.
- Rohay, V., J. Rossabi, B. Looney, R. Cameron, and B. Peters, 1993. Well venting and application of passive soil vapor extraction at Hanford and Savannah River. p. 315–322. *In Processes for Bioremediation*. Proc. ER'93 Environmental Remediation Conference. Augusta, GA. Battelle Memorial Institute, Columbus, OH.
- Samfield, M. 1995. Project Summary, Air Infiltration Measurements Using Tracer Gases: A Literature Review. United States Environmental Protection Agency, Air and Energy Engineering Research Laboratory. February 1995. Samfield, M. 1996. Project Summary, HVAC systems as a Tool in Controlling Indoor Air Quality; A Literature Review. United States Environmental Protection Agency, National Risk Management Research Laboratory. January 1996.
- San Diego DEH, 2003, Site Assessment and Mitigation Manual 2003, [http://www.sdcounty.ca.gov/deh/lwq/sam/manual\\_guidelines.html](http://www.sdcounty.ca.gov/deh/lwq/sam/manual_guidelines.html)
- Samet, Jonathan M., M.D., M.S., and J.D. Spengler. 1991. *Indoor Air Pollution – A Health Perspective*. The Johns Hopkins University Press. Baltimore.
- Samfield (1992): *Indoor Air Quality Data Base for Organic Compounds – Final Report: January to November 1991*. EPA-600-R-92-025 (NTIS PB92-158468), February.
- Sanders, P.F., and A.H. Stern. 1994. *Calculation of Soil Cleanup Criteria for Carcinogenic Volatile Organic Compounds as Controlled by the Soil-to-Indoor Air Exposure Pathway*. *Environmental Toxicology and Chemistry*, 13(8):1367-1373.
- Sanders, P. and I. Hers, 2004. Vapor Intrusion in Homes over Gasoline-Contaminated Groundwater in Stratford, NJ. Submitted for Publication in *Groundwater Monitoring and Remediation*, June 2004.



- Scotter, D.R., G.W. Thurtell, and P.A.C Raats. 1967. Dispersion resulting from sinusoidal gas flow in porous materials. *Soil Sci.* 104:306–308.
- Seifert, B., N. Englert, H. Sagunski, and J. Witten. 1999. *Guideline Values for Indoor Air Pollutants*. In: The 8<sup>th</sup> International Conference on Indoor Air Quality and Climate, August 8-13, 1999.
- Sexton, Ken and Steven B. Harvard. 1987. *Source Apportionment of Indoor Air Pollution*. *Atmospheric Environment*, 21(2):407-418.
- Sexton, K. J.L. Adgate, G. Ramachandran, G.C. Pratt, S.J. Mongin, T.H. Stock, and M.T. Morandi, 2004. Comparison of Personal, Indoor and Outdoor Exposures to Hazardous Air Pollutants in Three Urban Communities, *Environmental Science and Technology* 15; 38(2): 423-30.
- Shaefer, C.E., R.R. Arands, D.S. Kosson. 1998. *Modeling of the Gaseous Diffusion Coefficient in the Presence of NAPL*. *Journal of Contaminant Hydrology*, 33:431-437.
- Shah, J.J. and H.B. Singh. 1988. *Distribution of volatile organic chemicals in outdoor and indoor air. A national VOCs data base*. *Env. Sci. Technol.*, 22(12):1381-1388.
- Shah, J.J. and E.K. Heyerdahl (1988): *National Ambient Volatile Organic Compounds (VOCs) Data Base Update*. EPA/600/3-88//010(a), February.
- Shan, Chao, and Daniel B. Stephens. 1995. *An Analytical Solution for Vertical Transport of Volatile Chemicals in the Vadose Zone*. *Journal of Contaminant Hydrology*, 18:259-277.
- Sheldon, Andrew B., Robert L. Siegrist, and Helen E. Dawson. 2000. *Experimental Validation and Reliability Evaluation of Multimedia Risk Assessment Models*. EPA Grant No. R825411, v5.0. Colorado School of Mines, Environmental Science & Engineering Division, Center for Environmental Risk Assessment, Golden, Colorado.
- Sheldon et al. (1992): *Indoor Pollutant Concentrations and Exposures*. California Air Resources Board, Contract A833-156, Final Report, January.
- Sheldon, Linda S., Charles M. Sparacin, and Edo D. Pellizzari. 1983. *Review of Analytical Methods for Volatile Organic Compounds in the Indoor Environment*. In: *Indoor Air and Human Health*. Ed. by R. Gammage and S. Kaye. Lewis Publishers, Chelsea, Michigan.
- Shen, T., 1981. Estimating Hazardous Air Emissions From Disposal Sites. *Pollut. Eng.* 13: 31-34.
- She, Yuanyin, B. Sleep, and D. Mackay. 1995. *A Fugacity Model for Soil Vapor Extraction*. *Journal of Soil Contamination*, 4(3):227-242.
- Shen, T.T., and T. James Tofflemire. 1980. *Air Pollution Aspects of Land Disposal of Toxic Wastes*. *Journal of the Environmental Engineering Division*, 106(EE1):211-225.

---

References

Shields, H.C., and C.J. Weschler. 1987. *Analysis of Ambient Concentrations of Organic Vapors with a Passive Sampler*. JAPCA, 37:1086-1093.

Shields, H.C., D.M. Fleischer, and C.J. Weschler (1996): Comparisons among VOCs measured in three types of commercial buildings with different occupant densities. *Indoor Air*, 6: 2-17.

Shinn, J., B. Mallon, and S. Martins. 1992. *Hydrologic Properties of the Vadose Zone at B292*. UCRL-ID-111733, Lawrence Livermore National Laboratory, Livermore, CA.

Shoemaker, C.A., T.B. Culver, L.W. Lion, and M.G. Peterson. 1990. *Analytical Models of the Impact of Two-Phase Sorption on Subsurface Transport of Volatile Chemicals*. Water Resources Research, 26(4):745-758.

Slattery, J.C., and R.B. Bird. 1958. *Calculation of the Diffusion Coefficient of Dilute Gases and of the Self-Diffusion Coefficient of Dense Gases*. A.I.Ch.E. Journal, 4(2):137-142.

Sleep, B.E. and J.F. Sykes. 1989. *Modeling the Transport of Volatile Organics in Variably Saturated Media*. Water Resources Research, 25(1):81-92

Smith, J.A., A.K. Tisdale, and J.H. Cho, 1996. Quantification of Natural Vapor Fluxes of Trichloroethene in the Unsaturated Zone at the Picatinny Arsenal, New Jersey, Environmental Science and Technology, v 30 pp 2243-2250.

Sokal, Robert R. and James F. Rohlf. 1981. *Biometry: The Principles and Practices of Statistics in Biological Research*. 2<sup>nd</sup> edition. W.H. Freeman and Co., San Francisco.

Sparks, L.E.; Tichenor, B.A.; Chang, J.; Guo, Z. Gas-Phase Mass Transfer Model of Predicting Volatile Organic Compound (VOC) Emission Rates from Indoor Pollutant Sources; Indoor Air 1996, 6, 31-40.

Srivastava, Vipul J. MGP Site Remediation Strategies and a Review of Available Technologies and IGT's Innovative Approaches. Proceedings from the 20th World Gas Conference, Kobenhavn, 1997. Accessed through <http://www.hsrg.org/hsrg/html/tosc/sswtosc/mgp.html>

Standard Guide for Risk-Based Corrective Action Applied at Petroleum Re-lease Sites; E-1739-95; American Society for Testing and Materials: West Conshohocken, PA, 1995.

Stein, V.B., J.P.A. Hettiaratchi, and G. Achari. 2001. "A Numerical Model for Biological Oxidation and Migration of Methane in Soils." ASCE Practice Periodical of Hazardous, Toxic, and Radioactive Waste Management 5(4): 225-234.

Stock, T.H., M.T. Morandi, G.C. Pratt, D. Bock, and J.H. Cross. 1999. *Comparison of the Results of VOC Monitoring with Diffusive Samplers and Canisters*. In: The 8<sup>th</sup> International Conference on Indoor Air Quality and Climate, August 8-13, 1999.

Stolwijk, J.A.J. 1990. *Assessment of Population Exposure and Carcinogenic Risk Posed by Volatile Organic Compounds in Indoor Air*. Risk Analysis, 10(1):49-57.

- Swartjes, F.A., 2002. Variation in calculated human exposure; comparison of calculations with seven European human exposure models. RIVM report 711701030 / 2002, National Institute for Public Health and the Environment, The Netherlands.
- Ter Meer, J., R. Lubbers, and A. Sinke. 1999. *Risicoreductie van vluchtige verbindingen door afbraak in de onverzadigde zone*. Report TNO-MEP-R99/089, TNO Institute of Environmental Sciences, energy Research and Process Innovation, Apeldoorn, The Netherlands.
- Thorstenson, D.C. and D.W. Pollack, 1989. Gas Transport in Unsaturated Porous Media: The Adequacy of Fick's Law. *Rev. Geophys.* 27: 61-78.
- Tichenor, B.A.; Sparks, L.S.; White, J.B.; Jackson, M.D. Evaluating Sources of Indoor Air Pollution; *J. Air & Waste Manage. Assoc.* 1990,40 (4), 487-492.
- Total Petroleum Hydrocarbon Criteria Working Group Series, 1998. Analysis of Petroleum Hydrocarbons in Environmental Media Amherst Scientific Publishers 150 Fearing Street Amherst, Massachusetts 01002 © 1998 by Amherst Scientific Publishers. ISBN 1-884-940-14-5.
- Travis, Curtis C. and Miriam L. Land. 1990. *Estimating the Mean of Data Sets with Non-Detectable Values*. *Env. Sci. Tech.*, 24(7):961-962.
- Turczynowicz, Leonid, and Neville Robinson. 2001. *A Model to Derive Soil Criteria for Benzene Migrating from Soil to Dwelling Interior in Homes with Crawl Spaces*. *Human and Ecological Risk Assessment*, 7(2):387-415.
- Uchiyama, S., and S. Hasegawa. 2000. Investigation of a long-term sampling period for monitoring volatile organic compounds in ambient air. *Environ. Sci. Technol.* 34: 4656-4661.
- Underwood. 1992. *Exposure Pathway Analysis: Inhalation of organic compounds which have volatilized from contaminated groundwater and accumulated indoors*. By Impact Assessment, Inc, for CA Dept. Health Services, Emeryville, CA, 16 pgs.
- Unger, D.R., T.T. Lam, C.E. Schaefer, and D.S. Kosson. 1996. *Predicting the Effect of Moisture on Vapor-Phase Sorption of Volatile Organic Compounds to Soils*. *Env. Sci. Tech.*, 30(4):1081-1091.
- U.S. DOE (Department of Energy). 1995. *Housing Characteristics*. Report No. DOE/EIA-0314(93). Energy Information Administration. Washington, DC.
- United States Department of Labor, Occupational Safety and Health Administration. 2004. Permissible Exposure Limits. <http://www.osha.gov/SLTC/pel/>
- United States Environmental Protection Agency (US EPA), 2004. Standard Operating Procedure (SOP) for Installation of Sub-Slab Vapor Probes and Sampling Using EPA Method TO-15 to Support Vapor Intrusion Investigations, ORD, Ada, OK, DRAFT – February 12, 2004.

---

References

- United States Environmental Protection Agency (US EPA), 2003a. Vapor Intrusion and RCRA Corrective Action (CA); Environmental Indicators (EI) Fact Sheet. Office of Emergency and Remedial Response. June 17, 2003.
- United States Environmental Protection Agency (US EPA), 2003b. User's Guide for Evaluating Subsurface Vapor Intrusion into Buildings. Office of Emergency and Remedial Response. June 19, 2003.
- United States Environmental Protection Agency (US EPA), 2002a. CFR Promulgated Test Methods. Method 16. Technology Transfer Network, Emission Measurement Center. Washington, D.C. <http://www.epa.gov/ttn/emc/promgate.html>. February.
- United States Environmental Protection Agency (US EPA), 2002b. OSWER Guidance for Evaluating the Vapor Intrusion to Indoor Air Pathway from Groundwater and Soils (Subsurface Vapor Intrusion Guidance). November 29.
- <http://www.epa.gov/epaoswer/hazwaste/ca/eis/vapor.htm> Draft.
- United States Environmental Protection Agency (US EPA), 2002c. Integrated Risk Information System (IRIS). National Center for Environmental Assessment, Office of Research and Development, Washington, DC. <http://www.epa.gov/iris/subst/index.html>.
- United States Environmental Protection Agency (US EPA), 2002d. Resource Conservation and Recovery Act (RCRA) Environmental Indicators (EI) Guidance. U.S. EPA. Washington, D.C.
- United States Environmental Protection Agency (US EPA), 2002e. *Role of Background in the CERCLA Cleanup Program*. OSWER 9285.6-07P. Office of Solid Waste and Emergency Response, Washington, DC, April (<http://www.epa.gov/superfund/programs/risk/role.pdf>).
- United States Environmental Protection Agency (US EPA), 2001a. *Draft Supplemental Guidance for Evaluating the Vapor Intrusion to Indoor Air Pathways*. Draft for Comment. Office of Solid Waste. Washington, DC. October 23.
- <http://www.epa.gov/epaoswer/hazwaste/ca/eis/vapor.htm>.
- United States Environmental Protection Agency (US EPA), 2001b. *Supplement to the Soil Screening Guidance*. Peer Review Draft. Office of Emergency and Remedial Response (OERR). Washington, DC., March.
- United States Environmental Protection Agency (US EPA), 2001c. Building Radon Out, A Step-by-Step Guide On How To Build Radon Resistant Homes. Office of Air and Radiation; Document No. EPA/402-K-01-002. April 2001.
- United States Environmental Protection Agency (US EPA) and the United States Army Corps of Engineers, 2001d. Field Analytical Technologies Encyclopedia (FATE). Washington D.C. <http://fate.clu-in.org/> . Updated January.

- United States Environmental Protection Agency (US EPA), 1999a. *Revised Risk Assessment for the Air Characteristic Study. Volume II. Technical Background Document*. EPA530-R-99-019b. Office of Solid Waste, Washington, DC. August.
- United States Environmental Protection Agency (US EPA), 1999b. Compendium Method TO-14A, Determination Of Volatile Organic Compounds (VOCs) In Ambient Air Using Specially Prepared Canisters With Subsequent Analysis By Gas Chromatography; Compendium of Methods for the Determination of Toxic Organic Compounds in Ambient Air, Second Edition. Center for Environmental Research Information, Office of Research and Development. January 1999.
- United States Environmental Protection Agency (US EPA), 1999c. *Compendium of Methods for the Determination of Toxic Organic Compounds in Ambient Air – Second Edition*. (EPA/625/R-96/010b) Center for Environmental Research Information.
- United States Environmental Protection Agency (US EPA) / BASE, 1999: Data presentation at Indoor Air Conference, Edinberg.
- United States Environmental Protection Agency (US EPA), 1998a. Inside IAQ. EPA's Indoor Air Quality Research Update. EPA/600/N-98/002. Office of Research and Development. Research Triangle Park, NC. Spring/Summer.
- United States Environmental Protection Agency (US EPA), 1998b. SW-846 Manual. Revision 5. Office of Solid Waste. Washington, D.C.  
<http://www.epa.gov/epaoswer/hazwaste/test/main.htm>. April.
- United States Environmental Protection Agency (US EPA), 1998c: A Comparison of Indoor and Outdoor Concentrations of Hazardous Air Pollutants. *Inside IAQ*, Spring/Summer, 1-7.
- United States Environmental Protection Agency (US EPA), 1997a. *Health Effects Assessment Summary Tables (HEAST), FY 1997 Update*. EPA-540-R-97-036. Office of Emergency and Remedial Response, Washington, DC.
- United States Environmental Protection Agency (US EPA), 1997b. *Exposure Factors Handbook, Volume I, General Factors*. EPA/600/P-95/002Fa. Office of Research and Development, Washington, DC. August.
- United States Environmental Protection Agency (US EPA), 1997c. *Exposure Factors Handbook, Volume III, Activity Factors*. EPA/600/P-95/002Fa. Office of Research and Development, Washington, DC. August.
- United States Environmental Protection Agency (US EPA), 1997d. National Advisory Committee for Acute Exposure Guideline Levels for Hazardous Substances: Notices. *Federal Register* 62 FR 58839-58851. October 30.

---

References

- United States Environmental Protection Agency (US EPA), 1997e, Expedited site assessment tools for underground storage tank sites: A guide for regulators, EPA 510/B/97/001, March 1997, Washington, D.C.
- United States Environmental Protection Agency (US EPA), 1997f. *User's Guide for the Johnson and Ettinger (1991) Model for Subsurface Vapor Intrusion Into Buildings*. Prepared by Environmental Quality Management, Inc. Contract No. 68-D30035. September 1997. [[http://www.epa.gov/superfund/programs/risk/airmodel/johnson\\_ettinger.htm](http://www.epa.gov/superfund/programs/risk/airmodel/johnson_ettinger.htm)]
- United States Environmental Protection Agency (US EPA), 1997g. *Test Methods for Evaluating Solid Waste – Physical and Chemical Methods – Integrated Manual*. (SW-846; final update III). Office of Solid Waste and Emergency Response.
- United States Environmental Protection Agency (US EPA), 1997 - 2000. Spreadsheets for the Johnson and Ettinger (1991) Model. Prepared by Environmental Quality Management, Inc. [http://www.epa.gov/superfund/programs/risk/airmodel/johnson\\_ettinger.htm](http://www.epa.gov/superfund/programs/risk/airmodel/johnson_ettinger.htm)
- United States Environmental Protection Agency (US EPA), 1996a. *Soil Screening Guidance: User's Guide*. EPA/540/R-96/018. Office of Solid Waste and Emergency Response. Washington, DC.
- United States Environmental Protection Agency (US EPA), 1996b. *Soil Screening Guidance: Technical Background Document*. EPA/540/R-95/128. Office of Solid Waste and Emergency Response. Washington, DC., 161 p.
- United States Environmental Protection Agency (US EPA), 1996c. CFR Promulgated Test Methods. Method 3. Technology Transfer Network, Emission Measurement Center. Washington, D.C. <http://www.epa.gov/ttn/emc/promgate.html>. June.
- United States Environmental Protection Agency (US EPA), 1996d. Soil Gas Sampling. Standard Operating Procedure No. 2042. Environmental Response Team. Washington, D.C., June 1, 1996.
- United States Environmental Protection Agency (US EPA), 1996e. (revised from July 1996) *Region I, EPA-New England Data Validation Functional Guidelines for Evaluating Environmental Analyses*. U.S. EPA-New England, Region I. Quality Assurance Unit Staff. Office of Environmental Measurement and Evaluation.
- United States Environmental Protection Agency (US EPA), 1995a. *Review of Mathematical Modeling for Evaluating Soil Vapor Extraction Systems*. EPA/540/R-95-513. Office of Research and Development, Washington, DC.
- United States Environmental Protection Agency (US EPA), 1995b, SUMMA™ canister sampling, U.S. Environmental Protection Agency Environmental Response Team, Standard Operating Procedure 1704, July 27, 1995, Washington, D.C., 8 p.

United States Environmental Protection Agency. 1995c. Passive Radon Control System for New Construction. Indoor Environmental Division, Office of Radiation and Indoor Air, Document No. EPA 402-95012. May 1995.

United States Environmental Protection Agency (US EPA), 1994a, Tedlar™ bag sampling, U.S. Environmental Protection Agency Environmental Response Team, Standard Operating Procedure 2102, October 10, 1994, Washington, D.C., 5 p.

United States Environmental Protection Agency (US EPA), 1994b, "Summa Canister Cleaning Procedures, SOP #1703, Rev. #: 0.0," 09/01/94; [http://www.ert.org/respons\\_resrcs/sops.asp](http://www.ert.org/respons_resrcs/sops.asp)

United States Environmental Protection Agency (US EPA), 1994c, *Methods for Derivation of Inhalation Reference Concentrations and Application of Inhalation Dosimetry*. EPA/600/8-90-066F. Environmental Criteria and Assessment Office, Office of Health and Environmental Assessment, Office of Research and Development, Research Triangle Park, NC.

United States Environmental Protection Agency (US EPA), 1994d, Guidance for the Data Quality Objectives Process (EPA QA/G-4). Office of Research and Development, Document No. EPA/600/R-96/055. September 1994.

United States Environmental Protection Agency (US EPA), 1993a, Behaviour and Determination of Volatile Organic Compounds in Soil: A Literature Review. Report EPA/600/SR-93/140.

United States Environmental Protection Agency (US EPA), 1993a. Radon Prevention in the Design and Construction of Schools and Other Large Buildings. Office of Research and Development, Document No. EPA/625/R-92/016. January 1993.

United States Environmental Protection Agency (US EPA), 1992a. Air/Superfund National Technical Guidance Study Series: Assessing Potential Indoor Air Impacts at Superfund Sites. Office of Air Quality Planning and Standards. Research Triangle Park. North Carolina. Report EPA/451/R-92/002.

United States Environmental Protection Agency (US EPA), 1992b. Overview of Air Pathway Assessments for Superfund Sites (Revised), Volume 1; Air/Superfund National Technical Guidance Study Series. Agency Office of Air Quality, Planning and Standards, Research Triangle Park, Report No. ASF-1a. November 1992.

United States Environmental Protection Agency (US EPA), 1992c. *Guidance for Data Usability in Risk Assessment (Part A) Final*. (Publication 9285.7-09A PB92-963356) Office of Emergency and Remedial Response.

United States Environmental Protection Agency, Office of Air and Radiation, 1992d. "Indoor Radon and Radon Decay Product Measurement Device Protocols" (6604J) EPA 402-R-92-004, July 1992 (revised)

---

References

- United States Environmental Protection Agency (US EPA), 1991a. Radon-Resistant Construction Techniques for New Residential Construction; Technical Guidance. Office of Research and Development; Document No. EPA/625/2-91/032. February 1991.
- United States Environmental Protection Agency (US EPA), 1991b: *IAQ Reference Manual*, July.
- United States Environmental Protection Agency (US EPA), 1990a. *Compendium of Methods for Determination of Air Pollutants in Indoor Air*. By staff of Engineering Science for Atmospheric Research and Exposure Assessment Laboratory, Office of Research and Development, EPA. Research Triangle Park, North Carolina. EPA/600/4-90-010.
- United States Environmental Protection Agency (US EPA), 1990b: *Nonoccupational Pesticide Exposure Study (NOPES), Final Report*. EPA/600/3-90/003 (NTIS PB90-152224), January.
- United States Environmental Protection Agency (US EPA), 1989. *Risk Assessment Guidance for Superfund: Human Health Evaluation Manual Part A*. EPA/540/1-89/002. Washington, DC.
- United States Environmental Protection Agency (US EPA), 1988a. EPA Guidance for Quality Assurance Project Plans. (EPA/600/R-E8/018).
- United States Environmental Protection Agency (US EPA), 1988b. *The Inside Story: A Guide to Indoor Air Quality*. Office of Air and Radiation/Consumer Product Safety Commission.
- United States Environmental Protection Agency (US EPA), 1988c. *Methods for the Determination of Organic Compounds in Drinking Water*. Environmental Monitoring Systems Laboratory. (EPA/600/4-88/039).
- United States Environmental Protection Agency (US EPA), 1988d. *National Ambient Volatile Organic Compounds (VOCs) DataBase Update*. (EPA/600/3-88/010(a)) Atmospheric Sciences Research Laboratory. Research Triangle Park. North Carolina.
- United States Environmental Protection Agency (US EPA), 1987. *The Total Exposure Assessment Methodology (TEAM) Study: Summary and Analysis, Volume 1*, U.S. Environmental Protection Agency, Washington, DC, EPA-600/6-87 002a (PB88-100060).
- United States Environmental Protection Agency (US EPA), 1984. *Compendium of Methods for the Determination of toxic Organic Compounds in Ambient Air*. Compiled by R.M. Riggan of Batelle-Columbus Laboratories, Columbus, Ohio for Environmental Monitoring System Laboratory, EPA, Research Triangle Park, North Carolina.
- VDOH (Vermont Department of Health). June 1993. *Indoor Air Study Questionnaire*. Toxicology and Risk Assessment Program.
- van Genuchten, T. T., 1980, *A closed form equation for predicting hydraulic conductivity of unsaturated soils*, Soil Sci. Soc. Amer. J., 44, 892-898.



- Vermont Department of Health (1992): *Indoor Ambient Air Survey Results, Yearly Sampling 12/21/91-12/20/92*, Internal Report.
- Vogel, T., K. Huang, R. Zhang, and M. Th. van Genuchten, 1998. *The HYDRUS Code for Simulating One-Dimensional Water Flow, Solute Transport, and Movement in Variably Saturated Media*. Version 5.0. Research Report No. 140. U.S. Salinity Laboratory, Agricultural Research Service, U.S. Department of Agriculture, Riverside, California.
- Waitz, M.F.W., J.I. Freijer, P. Kreule, and F.A. Swartjes. 1996. *The VOLASOIL Risk Assessment Model Based on CSOIL for Soils Contaminated with Volatile Compounds*. RIVM report 715810014. RIVM, Bilthoven, The Netherlands.
- Wallace L.A. 1989. "Major Sources of Benzene Exposure." *Environmental Health Perspectives* 32: 165-169.
- Wallace, Lance A. 1991. *Comparison of Risks from Outdoor and Indoor Exposure to Toxic Chemicals*. *Environ. Health Perspectives*, 95:7-13.
- Wallace, L.A. (1987). Project Summary: The Total Exposure Assessment Methodology (TEAM) Study, U.S. Environmental Protection Agency, Washington, DC, EPA/600/S6-87/002.
- Wallace, L.A., E.D. Pellizzari, T.D. Hartwell, C.M. Sparacino, L.S. Sheldon and H. Zelon(1985). "Personal Exposures, Indoor-Outdoor Relationships, and Breath Levels of Toxic Air Pollutants Measured for 355 persons in New Jersey", *Atmospheric Environment*, **19**(10), 1651-1661.
- Watson, G.W., Staples, E.J., and S. Viswanathan, 2003. Real Time Odor and VOC Emission Measurements Associated With Environmental Remediation Sites using GC/SAW, Air and Waste Management Annual Conference June 22-26, 2003, San Diego, California  
[http://www.znose.com/tech\\_papers/papers/Environmental/SiteOdorMeasurements\\_awma.pdf](http://www.znose.com/tech_papers/papers/Environmental/SiteOdorMeasurements_awma.pdf)
- Weeks, E.P. 1979. *Barometric Fluctuations in Wells Tapping Deep Unconfined Aquifers*. *Water Resources Research*, 15:1167-1176.
- Weeks, E.P., D.E. Earp, and G.M. Thompson, 1982. *Use of atmospheric fluorocarbons F-11 and F-12 to determine the diffusion parameters of the unsaturated zone in the southern high plains of Texas*, *Water Resources Research*, v.18, 1365-1378.
- Weisel, C.P., M. Morandi, T. Stock, B. Turpin, J. Zhang, K. Mohan, S. Alimokhtari and J. Kwon (2001). Influence of Ambient Air Sources on VOC exposure in NJ in the RIOPA (Relationship among Indoor, Outdoor & Personal Air) Study. Presented at Eleventh Annual Meeting of the Society of Exposure Analysis, Charleston, SC, Nov. 4-8, 2001.
- Werner, M.D., 1985. The Effects of Relative Humidity on the Vapour Phase Adsorption of Trichloroethylene by Activated Carbon. *Am. Ind. Hyg. Assoc. J.*, v 46, n 10, pp 585-590.

---

References

- Williams, D.R., J.C. Pasalawski, and G.M. Richardson. 1996. *Development of a Screening Relationship to Describe Migration of Contaminant Vapors into Buildings*. Journal of Soil Contamination, 5(2):141-156.
- Wisconsin Department of Health and Family Services. 2003. Chemical Vapor Intrusion and Residential Indoor Air; Guidance for Environmental Consultants and Contractors. State of Wisconsin, Department of Health and Family Services, Division of Public Health. February 13, 2003.
- Wolff, B. (2003). *Indoor Air Background for VOCs. Determining Background Levels*. Draft presentation, Indiana Department of Environmental Management, November.
- Won, D. and R.L. Corsi. 1998. Development of an Indoor Environment Fate Model. Volume I. Literature Review. Department of Civil Engineering, University of Texas at Austin. Austin, TX.
- Zhang, J., L. Zhang, R. Harrington, C. Weisel, L. Korn, M. Morandi, T. Stock, S. Colome, B. Turpin and D. Spektor (2001). Indoor, Outdoor, In-Vehicle concentrations of airborne carbonyl compounds and their relation to personal exposure: Results from the RIOPA study. Presented at Eleventh Annual Meeting of the Society of Exposure Analysis, Charleston, SC, Nov. 4-8, 2001.

# **A**

## **INDOOR AIR QUALITY BUILDING SURVEY**

---

**(modified after NJDEP)**

## INDOOR AIR QUALITY BUILDING SURVEY

Date: \_\_\_\_\_ Project #: \_\_\_\_\_

Address: \_\_\_\_\_

\_\_\_\_\_

\_\_\_\_\_

Property Contact: \_\_\_\_\_

Phone: Home: ( ) \_\_\_\_\_ Work: ( ) \_\_\_\_\_ Cell: ( ) \_\_\_\_\_

Building Occupants: Children <13 \_\_\_\_\_ Children age 13-18 \_\_\_\_\_ Adults \_\_\_\_\_

**Building Construction Characteristics:** (Circle appropriate description)

Single Family          Multiple Family          School          Commercial  
Ranch 2-Family          Raised Ranch Duplex          Colonial # of units \_\_\_\_\_  
Split Level Condominium          Mobile Home          Other (specify) \_\_\_\_\_

General Description of Building Construction Materials, especially new materials:

\_\_\_\_\_

\_\_\_\_\_

How many occupied stories does the building have? \_\_\_\_\_

Has the building been weatherized with any of the following? (Circle all that apply)

Insulation      Storm Windows          Energy-Efficient Windows

Other (specify) \_\_\_\_\_

What type of basement does the building have? (Circle all that apply)

Full basement      Crawlspace          Slab-on-Grade          Other (specify) \_\_\_\_\_

Basement Size \_\_\_\_\_ (ft<sup>2</sup>)

Surveyor's Initials: \_\_\_\_\_

## INDOOR AIR QUALITY BUILDING SURVEY

Describe Basement Floor and Walls: \_\_\_\_\_

Moisture: Always Dry Always Wet Frequently Wet Sometimes Wet

Is a basement sump present? (Y/N) Is a sump pump present? (Y/N) (circle one)

Does the basement have any preferential pathways that might permit soil vapor entry? (Circle all that apply)

Visible Cracks Unsealed Pipes/Utility Conduits Sump pumps

What type of ground cover surrounds the outside of building? (Circle all that apply)

Grass Concrete Asphalt Other (specify) \_\_\_\_\_

### Heating and Ventilation System(s) Present:

What type of heating system(s) is (are) used in this building? (Circle all that apply)

Hot Air Circulation Heat Pump Steam Radiation Wood Stove

Hot Air Radiation Unvented Kerosene heater Electric Baseboard

Other (specify): \_\_\_\_\_

What type (s) of fuel(s) are used in this building? (Circle all that apply)

Natural Gas Electric Coal Other (specify): \_\_\_\_\_

Fuel Oil Wood Solar

What type of mechanical ventilation systems are present and/or currently operating in the building? (Circle all that apply)

Central Air Conditioning Bathroom Fan Kitchen fan

Individual Air Conditioning Units Air-to-Air Heat Exchanger

Open windows Other (specify): \_\_\_\_\_

Septic system? Yes / Yes (but not used) / No

Irrigation/private well? Yes / Yes (but not used) / No

Existing subsurface depressurization (radon) system in place? Yes / No

If yes, is it running? Yes / No

Surveyor's Initials: \_\_\_\_\_

Page 2 of 5

## INDOOR AIR QUALITY BUILDING SURVEY

**Sources of Chemical Contaminants:**

Which of these items are present in the building?

Potential Sources Location(s)	Check if Present	Removed Prior to Sampling? (Yes / No / NA)
Paints or paint thinners		
Gas-powered equipment		
Gasoline storage cans		
Cleaning solvents		
Air fresheners		
Oven cleaners		
Carpet/upholstery cleaners		
Hairspray		
Nail polish/polish remover		
Bathroom cleaner		
Appliance cleaner		
Furniture/floor polish		
Moth balls		
Fuel tank		
Wood stove		
Fireplace		
Perfume/colognes		
Hobby supplies (e.g., solvents, paints, lacquers, glues, photographic darkroom chemicals)		
Scented trees, potpourri, etc.		
Other:		
Other:		
Other:		

Do one or more smokers occupy this building on a regular basis (Y/N)?

How often? \_\_\_\_\_

Has anybody smoked in the building in the last 48 hours (Y/N)?

Does the building have an attached garage (Y/N)? If so, is a car usually parked in the garage (Y/N)?

Do the occupants of the building frequently have their clothes dry-cleaned (Y/N)?

Was there any recent remodeling or painting done in the building (Y/N)?

Surveyor's Initials: \_\_\_\_\_

## INDOOR AIR QUALITY BUILDING SURVEY

Are there any pressed wood products in the building (e.g., hardwood plywood wall paneling, particleboard, fiberboard) (Y/N)?

Are there any new upholstery, drapes or other textiles in the building (Y/N)?

Have the occupants ever noticed any unusual odors in the building? (Y/N)?

If yes, describe odors, location(s), and conditions that seem to affect odors (especially rain, temperature, wind):

---

---

Any known spills of a chemical immediately outside or inside the building? (Y/N)?

If yes, describe (location, age, type of chemical, any actions to clean up):

---

---

---

Has the building been treated (inside or outside) with any insecticides/pesticides(Y/N)? If so, what chemicals are used and how often are they applied:

---

---

### Outdoor Sources of Contamination:

Nearby Gasoline Stations (distance and direction):

---

---

---

---

Surveyor's Initials: \_\_\_\_\_

Page 4 of 5

## INDOOR AIR QUALITY BUILDING SURVEY

Industrial Stack Emissions (distance and direction):

---

---

---

Automotive emission sources (e.g., highway; bus stop; high-traffic area):

---

---

---

### Weather Conditions During Sampling:

Outside Temperature (°F): \_\_\_\_\_

Prevailing wind speed and direction: \_\_\_\_\_

Describe the general weather conditions (e.g., sunny, cloudy, rain): \_\_\_\_\_

Precipitation >0.1 inches within 12 hours preceding the sampling event (Y/N)? \_\_\_\_\_

General Comments: \_\_\_\_\_

Is there any other information about the structural features of this building, the habits of its occupants or potential sources of chemical contaminants to the indoor air that may be of importance in facilitating the evaluation of the indoor air quality of the building?

---

---

---

---

The responses documented on this survey are true, accurate and complete to the best of my knowledge and ability.

\_\_\_\_\_  
Name of Surveyor

\_\_\_\_\_  
Signature

\_\_\_\_\_  
Date

Surveyor's Initials: \_\_\_\_\_



# ***B***

## **NEW JERSEY DEP INSTRUCTIONS FOR OCCUPANTS**

---

















# Instructions for Occupants

## - Indoor Air Sampling Events

Representatives of the New Jersey Department of Environmental Protection (NJDEP) or an environmental consulting firm will be collecting one or more indoor air samples from your building in the near future. In order to collect an indoor air sample in your structure that is both representative of indoor conditions and avoids the common sources of background air contamination associated with household activities and consumer products, the NJDEP requests your assistance.

**Please follow the instructions below starting at least 48 hours prior to and during the indoor air-sampling event:**

-  Operate your furnace and whole-house air conditioner as appropriate for the current weather conditions
-  Do not use wood stoves, fireplaces or auxiliary heating equipment
-  Do not open windows or keep doors open.
-  Avoid using window air conditioners, fans or vents
-  Do not smoke in the building
-  Do not use air fresheners or odor eliminators
-  Do not use paints or varnishes (up to a week in advance, if possible)
-  Do not use cleaning products (e.g., bathroom cleaners, furniture polish, appliance cleaners, all-purpose cleaners, floor cleaners)
-  Do not use cosmetics, including hair spray, nail polish remover, perfume, etc.
-  Avoid bringing freshly dry-cleaned clothes into the building
-  Do not partake in hobbies indoor that use solvents
-  Do not apply pesticides
-  Do not store containers of gasoline, oil or petroleum-based or other solvents within the building or attached garages (except for fuel oil tanks)
-  Do not operate or store automobiles in an attached garage
-  Do not operate gasoline-powered equipment within the building, attached garage or around the immediate perimeter of the building

You will be asked a series of questions about the structure, consumer products you store in your building, and household activities typically occurring in the building. These questions are designed to identify “background” sources of indoor air contamination. While this investigation is looking for a select number of chemicals related to the subsurface contamination, the laboratory will be analyzing the indoor air samples for a wide variety of chemicals. Thus, tetrachloroethylene used in dry cleaning or acetone found in nail polish remover might be found in your sample results.

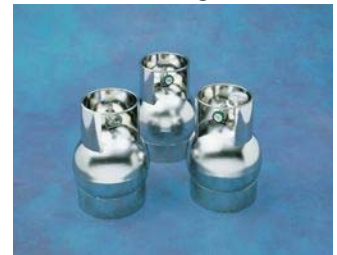

*Typical air sampling canister*

Your cooperation is greatly appreciated. If you have any questions about these instructions, please feel free to contact the NJDEP at

# C

## INDOOR AIR QUALITY SAMPLING FORM

---

(modified after NJDEP)

(modified after NJDEP)

**Indoor Air Quality Sampling Form**

**General Sampling Information:**

Sample Technician: \_\_\_\_\_ Phone number: ( ) \_\_\_\_\_ - \_\_\_\_\_

Sampler Type: Tedlar/Sorbent/Canister Analytical Method: TO-15 / TO-17 / other: \_\_\_\_\_

Laboratory: \_\_\_\_\_ Location: \_\_\_\_\_

Sample #	Floor	Room	Canister /Tube #	Pump ID #	Sample Start	Sample End

Barometric Pressure at Start of Sampling Period: \_\_\_\_\_

Barometric Pressure at End of Sampling Period: \_\_\_\_\_

**Sample location(s):**

**Provide Drawing of Sample Location(s) in Building**

Sample # \_\_\_\_\_ - \_\_\_\_\_

Sample # \_\_\_\_\_ - \_\_\_\_\_

Sample # \_\_\_\_\_ - \_\_\_\_\_

Review "Instructions for Residents" with occupants and describe any departures:

\_\_\_\_\_

\_\_\_\_\_

\_\_\_\_\_

\_\_\_\_\_

\_\_\_\_\_

\_\_\_\_\_

\_\_\_\_\_

\_\_\_\_\_

Sampler's Initials \_\_\_\_\_





# D

## SUGGESTED OPERATING PROCEDURE: SOIL GAS PROBE INSTALLATION

---

### D.1 Introduction and Overview

This suggested operating procedure (SOP) describes methods for soil gas probe installation for collecting soil gas samples and pneumatic monitoring data of sufficient quality to assess potential human health risks due to subsurface vapor intrusion to indoor air and subsequent inhalation exposures.

Soil gas probes can be constructed of a variety of materials and placed using a variety of drilling or driving methods. Selection among the various methods and designs should be made with knowledge of site-specific conditions, primarily, the depth of interest, the geologic materials, the gas-permeability and access constraints. This protocol emphasizes methods that will yield high quality monitoring data for a wide variety of site-specific conditions and attempts to provide guidance for the selection between methods to accommodate site-specific constraints.

The dominant concern with soil gas sampling is leakage that allows atmospheric air to enter the sample. Therefore, the integrity of the seal between the soil gas probe and the inner wall of the borehole in which the probe is installed (the borehole annulus) is of paramount importance. For example, a seal placed only at the ground surface will not prevent annular leakage between different depth intervals within the subsurface; therefore, the seal should be installed from just above the top of the soil gas probe screen to the ground surface. This is generally easy to accomplish in a borehole that is larger in diameter than the probe, where geologic materials have been removed by drilling or coring. Direct-push soil gas probes may provide representative samples if the gas permeability of the subsurface materials is moderate-to-high, the materials are sufficiently cohesionless to collapse around the probe, the purge volume is minimal and the vacuum exerted during purging is very low, but the absence of annular leakage of atmospheric air or cross-communication between intervals is difficult or impossible to independently verify. Therefore, the recommended procedure is to install soil gas probes within a borehole or corehole that have sand-pack around the screens and a slurry seal in the annulus above the sand pack.

Soil gas probes must be made of clean inert materials. Polyvinyl chloride (PVC), high-density polyethylene (HDPE), Teflon™, and nylon are generally preferred, but copper, brass, and stainless steel may also be used.

Probes may be of various lengths and diameters. A small diameter is generally preferable to reduce the volume of purging required prior to collection of a representative sample; however, there are practical limits associated with line losses. Therefore, recommended diameters range from ¼-inch for shallow probes (<10 ft), 1-inch diameter for intermediate depths (10 to 50 ft),

and 2-inch diameter for deep probes (>50 ft), although there is some flexibility within these ranges. Smaller diameters are beneficial for minimizing the volume that must be purged prior to sampling, and larger diameters provide additional flexibility for pneumatic testing, and possible future use for soil gas extraction, if required as part of a remedy.

The top of a soil gas probe must be sealed with an air-tight valve or cap to avoid atmospheric air entry which could be caused by barometric pressure fluctuations. The valves should be brass or stainless steel ball valves, since these impose minimal resistance to flow when fully open. Needle valves and gate valves should be avoided. The valves may have compression fittings (preferable) or barbed fittings (provided the tubing fits snug and at least three barbs are covered). Probes constructed of threaded PVC pipe should have a threaded cap, with the valve threaded into the cap, with all threads sealed with Teflon™ tape. Probes constructed of HDPE, Teflon™ or nylon tubing should have valves with compression fittings, preferably, although barbed valves can be used as long as the tubing is securely fitted over at least 3 barbs, which becomes increasing difficult with these inert tubing materials because they have very limited flexibility.

In cases where soil gas probes may be used for potential future monitoring events, they should be protected with a cover that will inhibit tampering or vandalism. The methods in this SOP are otherwise equally applicable for installation of permanent or temporary probes.

## **D.2 Permits and Utility Clearances**

All necessary permits should be secured in advance of any drilling activities. Underground utilities (water, sewer, electrical, gas, phone, etc.) should be reviewed prior to any drilling, and soil gas probe locations should avoid potential encounters with subsurface lines, backfill materials, or utility corridors.

## **D.3 Drilling/Coring**

The drilling/coring method will depend on the target depth, geologic materials, and access constraints. Hollow-stem auger drilling is feasible in most overburden and soft bedrock materials to depths of interest for vapor intrusion studies. The most common size for hollow-stem augers is nominal 7-inch outside diameter (O.D.), and 4-1/4 inch inside diameter (I.D.). Smaller boreholes or coreholes are often preferred, to minimize disturbance of the natural materials, especially for shallow probes designed to provide discrete resolution of vertical concentration profiles. For shallow probes (<5 ft), hand augering is an option, provided the subsurface materials are not too plastic, over-consolidated, or cobbly and the materials are not subject to collapse after the augers are withdrawn. Soil can be cored using percussive technology (GeoProbe™ or similar, slide-hammers, jackhammers, etc), where the percussive technology is used to collect a core and create a space for installing a probe, filter pack and seal. Percussive technologies can also be used for directly driving a soil gas probe (direct-push probes) although the potential for leakage along the outside of the probe cannot be reliably tested, which may not meet the data quality objectives required for human health risk assessment. Annular leakage for direct-push probes may be negligible where the geologic materials are sufficiently cohesionless to collapse around the probe, the gas-permeability is high enough to provide soil gas samples with minimal vacuum, the purge volume and vacuum are



minimized, and the depth below ground surface is generally more than about 5 feet. However, direct-push probes usually do not provide soil core, so they should only be used where the stratigraphy is well-known in advance and other drilling or coring methods are impracticable due to rig access constraints.

Bedrock that is too hard to be drilled using augers will generally require a rotary drilling or coring method. Air-rotary drilling or coring is feasible, but an inert tracer gas (e.g. Helium) should be added to the drill air. After the probe is installed and the seals have set, gas should be purged from the probe until the concentration of the tracer gas falls below 1% of the concentration injected into the drill air. This assures that the remaining soil gas is >99% from the subsurface. Water rotary or mud rotary methods will leave a filter cake on the borehole wall that will not be possible to remove through conventional well development techniques for intervals above the water table, so these methods are not recommended.

The optimal borehole diameter will vary depending on site-specific factors. In general, the borehole diameter must be large enough to allow careful placement of the sand-pack around the soil gas probe intake, and seals above the sand-pack. Larger diameters will be needed for multi-level installations with more than one probe per borehole. Standard hollow stem augers (8-inch outside diameter [OD], 4.25-inch inside diameter [ID]) can easily be used to install one 2-inch diameter soil gas probe, or up to three 1-inch diameter probes, or a bundle of five 1/4-inch diameter tubing probes, fastened around a 1-inch diameter center pipe. Standard solid-stem augers (4-inch OD) can be used for similar installations, where the geologic materials will not collapse after the augers are withdrawn. Drill or core-hole diameters should allow sufficient space to place seals and verify their placement using a tamping rod or weighted measuring tape.

#### **D.4 Geological Logging**

The geologic materials retrieved by drilling or coring should be visually inspected and recorded as a function of depth. If the probes are installed in close proximity, or if previous stratigraphic information is already available, the geologic materials may not need to be logged for each probe location. Where nested soil gas probes are planned, logging should be done for the materials in the deepest borehole only.

Soil samples should be collected for laboratory analysis of moisture content, fraction of organic carbon, and grain size distribution. Where a relatively undisturbed sample can be collected, it is also advantageous to collect samples for analysis of bulk density. Soil samples should be collected from representative stratigraphic layers. Analyses may include:

Soil Bulk Density: ASTM D2937.

Soil Moisture Content: ASTM D2216.

Fraction Organic Carbon: Walkley-Black method (Nelson and Sommers, 1992).

Grain Size: ASTM D422.

Visual inspections should include color, texture, plasticity, relative moisture, and any indications of staining from oils, fuels or solvents. If any soil is observed with freely-draining water from depths of more than a few feet above the water table, this may indicate a perched water condition, which is very significant with respect to the assessment of upward vapor transport.

Porous media with greater than about 70% water saturation may act as an effective barrier to vapor transport (Weeks et. al., 1982).

## **D.5 Probe Design and Assembly**

The most common soil gas probe assemblies will be constructed of HDPE, Teflon™ or Nylon tubing, or pre-fabricated PVC well screen and casing, although stainless steel, copper, or brass pipe is also acceptable. Probes may be installed in individual boreholes in close proximity (nested installations), or with more than one probe in a single borehole (multi-level installations). The selection of whether to use a single probe or multiple probes to provide a vertical profile of data must be made on a site-specific basis.

If off-gassing from groundwater is the suspected source of vapors to the unsaturated zone, it is often useful to collect shallow groundwater samples. Typical monitoring well designs are appropriate, although the screened interval must extend above the water table to ensure that the uppermost groundwater can be sampled, even if the water table fluctuates with climatic or seasonal changes. The length of the screened interval below the water table should also be minimized (5 feet or less is preferable). If the screened interval extends above the water table, it will be possible to draw a vacuum on the well and extract deep soil gas, provided the stagnant air in the well casing is adequately purged prior to sampling (typically at least a few casing volumes), with confirmation by stabilization of field screening readings using portable instruments to monitor VOC concentrations, O<sub>2</sub> and CO<sub>2</sub> (see SOP for soil gas probe sampling). Using water-table monitoring wells for the dual purpose of collecting shallow groundwater and deep soil gas samples provides a data that can be used to assess whether and to what extent there are any impediments to off-gassing of vapors from groundwater, which may be an important element of the conceptual model.

As with any sampling instrumentation, shorter screened intervals provide more discrete profiles of concentration and are therefore generally preferred. The length of the screen may be proportional to the thickness of the unsaturated zone, for example, a 10-foot screen in a 100-foot thick vadose zone provide comparable resolution to a 1-foot screen in a 10-foot thick vadose zone. Screened intervals may often be designed to correspond with stratigraphic intervals, which can be mapped by soil coring prior to probe construction. If a low-permeability layer is present in the unsaturated zone, and if infiltration is sufficient to maintain a high moisture content within or perched water above this layer, it may act as a partial or complete vapor barrier, so selective screen placement may be very important in some cases. Examples of various probe designs are shown in **Figure D-1**.

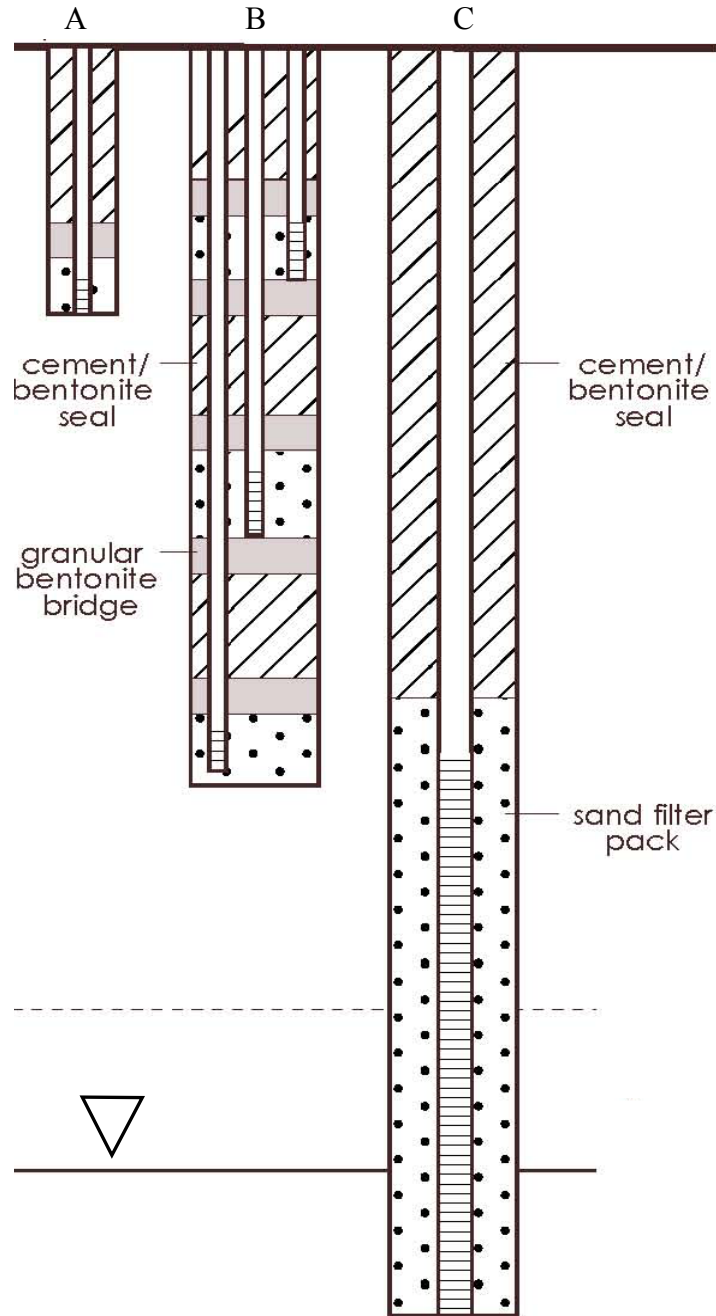

**Figure D-1**  
**Options For Soil Gas Probe Designs: A) Single Probe, B) Multi-Level Probes, and C)**  
**Combination Deep Soil Gas and Shallow Groundwater Probe**

### **D.5.1 PVC Well Screen and Riser Pipe**

Prefabricated PVC well screen and riser pipe is readily available, and comes in convenient lengths (typically 5 ft and 10 ft) and diameters (1-inch and 2-inch).

The optimal length of the screen may vary according to site-specific conditions. The screen length should generally be small relative to the depth of the screen, so as to provide discrete vertical profiles of soil gas chemistry and pneumatic properties. For example, shallow probes (<5 ft), should generally have screens of 6 inches to 1 foot in length. Deeper probes may have similar screen lengths, or they may have longer screened intervals. To maintain reasonable vertical resolution, the screen lengths of soil gas probes generally should not exceed roughly 1/10<sup>th</sup> of their depth (i.e. a 5-foot screen would be acceptable for a 50-foot deep probe), plus or minus a factor of 2, depending on the degree of vertical discretization that is desired. A convenient screen slot size is 0.010-inch, although soil gas probes are not subject to influx of soil particles, so larger slot sizes or drilled holes can be used, provided they are smaller than the filter sand or wrapped with nylon mesh.

In some cases, it may be valuable to collect co-located deep soil gas and shallow groundwater samples. A probe with a screen that straddles the water table will generally allow this, provided soil and groundwater are purged sufficiently with minimal vacuum or drawdown respectively. These probes must have sufficient diameter for a pump. Waterra™ pumps of 5/8<sup>th</sup>-inch diameter work well inside 1-inch PVC pipe.

To customize the probe design to the target depth, it will often be necessary to cut the prefabricated screen or casing materials to lengths different than the typical 5 and 10-foot lengths. A hacksaw is the best tool for cutting the PVC, but it is important to use a clean (preferably new) blade. A friction-fit slip cap may be used as the bottom plug to seal the bottom of the screen. The top of the probe must have a valve secured to the probe with an air-tight fitting. It is usually preferable to cut a thread into the outside of the riser pipe using a die of matching diameter, with standard NPT threads. A threaded cap should be placed over the top of the riser pipe, with a threaded fitting for the valve at the top of the probe. Threaded couplings for the cap and the flush-threaded couplings between the riser pipe segments and screen should be wrapped with Teflon™ tape and fastened tightly to prevent leaks. Glued couplings are not appropriate because glues will contribute vapors. Clean nitrile gloves should be used to handle the probe, and it should be kept on or in clean plastic sheeting until installation.

For multi-level installations of rigid pipe soil gas probes, it is generally preferable to have each probe installed separately, with sufficient distance between the probes to allow seals to surround each probe completely. If probes are in contact, it may block seals from completely filling all voids, and potentially result in a leak.

### **D.5.2 HDPE, Teflon™ or Nylon tubing**

HDPE, Teflon™ or Nylon tubing is generally preferable to PVC pipe for shallow soil gas probes (<5 ft depth), but may also be used for deeper probes. A diameter of 1/4 to 1/2-inch diameter will allow soil gas sampling and pneumatic testing with acceptably low line-losses. Smaller

diameters can be appealing for minimal purging; however, such small tubes are limited in their usefulness for larger volume purging and pneumatic testing because of line-losses at higher flow rates, and therefore, should be used selectively.

The screened interval of tubing probes can be constructed in the field by drilling small diameter holes in the tubing using a 1/8 to 1/16-inch drill bit. Roughly a dozen holes over a 3 to 6-inch interval are sufficient to allow soil gas flow at rates appropriate for sampling. A layer of nylon mosquito-mesh wrapped around the holes and bottom of the tubing and fastened with a nylon cable-tie is an effective way to ensure that sand pack materials will not inadvertently be drawn into the probe during pneumatic testing, purging and/or sampling.

Valves for the top of plastic tubing probes may be brass or stainless steel valves. Compression fittings are preferred, but barbed fitting are also acceptable, providing at least three barbs are inserted into the tubing for a secure fit. It may be necessary to heat the tubing to allow the barbs to seat deeper, especially for tubing that is very rigid.

### **D.5.3 Stainless Steel Screens**

Prefabricated stainless steel screens are available which can be threaded to tubing, and used as an alternative to drilled holes at the probe tip.

## **D.6 Backfilling**

The borehole backfill should consist of sand around the screen of the probe, a bridge of at least 6-inches of granular bentonite above the sand-pack, and a thick slurry of bentonite and water from above the bridge to within about 1 foot of ground surface. For multi-level installations, the slurry should be placed to about 6-inches below the bottom of the screen of the overlying probe, to allow another 6-inch granular bentonite bridge below the sand pack. If the multi-level screens are within a few feet of each other, it may be best to use multiple lifts of granular bentonite and water as seals in lieu of a slurry.

The sand filter pack surrounding the probes screen must be more permeable than the surrounding geologic materials to enable pneumatic testing to determine the gas-permeability of the natural geologic materials. In contrast to groundwater monitoring wells, the filter sands can be considerably more coarse-textured than the surrounding material without risking undesirable turbidity. Coarse sand to fine gravel-sized filter sand is preferred.

If the probe is constructed of tubing, a thin layer (one or two inches) of filter sand should be placed at the bottom of the borehole before the soil gas probe tube or pipe is emplaced. This will prevent plugging of the bottom of the probe with any cohesive geologic materials at the bottom of the borehole. Once the soil gas probe is emplaced, sand should be added to surround the screen, and extend a minimum of a few inches above the top of the screen. The position of the sand filter pack should be measured with a weighted tape and recorded on the soil gas probe installation log.

Immediately above the hydrated sand pack, a bridge of dry granular bentonite should be placed, a minimum of 2 inches thick. Granular bentonite has a texture like coarse sand particles, which is ideal because it will fall in the borehole with minimal risks of bridging above the top of the sand-pack, but it will also hydrate almost instantaneously with the addition of water. In fact, it is typically impossible to hydrate more than the upper inch of granular bentonite, so it should not be added in lifts of more than a few inches at a time without hydrating in between. A weighted tape or tamping rod should be used to ensure the granular bentonite bridge has been set to the desired level prior to hydrating. Above the granular bentonite bridge, a thick slurry of powdered bentonite and water can be used to seal the remainder of the borehole. If a single probe is installed in each borehole, this is relatively simple to implement using methods familiar to drillers for the placement of water well seals. A tremmie pipe should be used to place the slurry, especially where multi-level probes are specified, otherwise, the borehole walls and probe screens may become fouled.

For multi-level probes, a cement/bentonite slurry seal between probe intervals may not provide sufficient structural support to bear the weight of the overlying sand pack, in which case, bentonite chips should be added to the slurry to provide inter-granular friction, and sufficient bentonite powder should be added to make the mixture as thick as practicable. Prior to placement of a sand-pack above a slurry seal, another bridge of granular bentonite should be emplaced and hydrated, followed by at least a 2-inch layer of sand before the next probe screen is placed. The position of the sand lifts should be verified using a weighted measuring tape or tamping rod.

For vertical profiling with tubing, it can be very difficult to place multiple tubes into a single borehole independently, because of the tendency for the tubing to coil. One option is to feed the tubing down through a tremmie pipe of relatively narrow diameter (e.g. 1-inch), which will prevent coiling. The tip is set in filter sand as the tremmie pipe is slowly withdrawn, and after the granular bentonite bridge is set above the filterpack, the tremmie pipe can then be withdrawn, and be reused to install the next probe. Thick bentonite-slurry seals should be used between sampling intervals, isolated from the probe screens and filter packed intervals by a bridge of at least 6 inches of granular bentonite.

## **D.7 Protective Casings**

Protective casing should be used to provide protection from tampering, rainwater, traffic, or other potential threats to the integrity of the soil gas probe. Prefabricated units are available from suppliers of well casing materials. They may be either flush to grade or have a portion that stands above grade, depending on traffic, vegetation, and landowners preferences.

There must be sufficient space within the protective casings for access to the valves on top of the soil gas probes. For nested installations, it may be necessary to allow for 8-inch or larger diameter casings. The casings should be set in a minimum of 18-inches of concrete for permanence, and more if there is a portion above grade.

For flush-mount protective casings, the seal in the borehole should terminate at least 6 inches below the bottom of the protective casing, and sand backfill should be placed to the target depth of the bottom of the protective casing, as well as within the protective casing to a height of about

1 foot below grade. This sand lift will allow for drainage of any water that might accumulate inside the protective casing. Most flush-mount protective casings are supplied with a rubber gasket that should minimize water entry, but this drainage layer provides additional assurance that the soil gas probe integrity will not be compromised in the event of heavy rains.

## **D.8 Development and Equilibration**

Soil gas probes should be purged of a certain volume of soil gas after installation and before initial sampling is conducted to remove atmospheric air that may have entered the borehole during the drilling and installation procedure, and to promote the collection of reproducible samples of soil gas during subsequent sampling. Following the development, a period of time should be allowed for equilibration prior to the initial sampling event.

The volume to be purged during development and the time required for equilibration prior to sampling depend on site-specific factors. If probes were installed using augers, the volume of air in the augured hole should be removed during development, at a minimum. This can be calculated using:

$$V = \pi r^2 h$$

where  $r$  is the radius of the borehole,  $h$  is the depth, and  $\pi$  is 3.14.

It is generally preferable to perform field screening of the soil gas purged during the development procedure using portable instruments, which will typically include at least a photoionization detector (PID), or flame ionization detector (FID) for screening concentrations of total volatile organic compound (VOC) vapors. Landfill gas meters are also useful for screening concentrations of  $O_2$  and  $CO_2$ , especially if the subsurface vapors of concern at a particular site can be degraded by soil microbes under aerobic conditions (e.g. hydrocarbons). If probes were installed using air-rotary drilling and helium or other tracer gas, development should continue until the concentration of tracer in the extracted soil gas is less than 1% of the concentration used in the drilling air.

Field screening readings should stabilize as development progresses. As a rule of thumb, one field screening reading should be taken for each casing volume of soil gas removed. A casing volume is defined as the volume of gas in the soil gas probe, and does not include the volume of soil gas in the sand-pack materials surrounding the screen of the probe. In most cases, development will be complete after 5 to 10 casing volumes of soil gas are removed. Field screening readings should stabilize within a factor of about 10%, with no consistent increasing or decreasing trend over the course of 3 to 5 successive readings. Field screening samples should be collected in a Tedlar™ bag using a lung box, according to the procedure described in the Suggested Operating Procedure for Soil Gas Probe Sample Collection.

## **D.9 Testing of Seals between Multi-Level Probes**

For multi-level installations, a pneumatic test should be performed to assess the integrity of the seals between probes. The test consists of attaching a pump to one probe (the pumped probe),

and pumping at a rate sufficient to create a relatively high vacuum in the pumped probe (10 to 100 in-H<sub>2</sub>O), while measuring the pneumatic response (vacuum) in probes above and/or below the pumped probe. If the seals are competent, the vacuum in the overlying and underlying probes will generally be much less than the vacuum in the pumped probe. If the seals are not competent, a relatively high level of vacuum will be observed very quickly (within fractions of a second), and will dissipate very quickly when pumping ceases.

The apparatus for this test consists of a pump, flowmeter and two vacuum gauges of different scales (generally 1 to 100 in-H<sub>2</sub>O scale for measuring vacuum at the pumped probe and zero to 5 in-H<sub>2</sub>O for measuring vacuum at the probes above and below). The procedure involves pumping from the deepest probe and measuring the vacuum in the pumped probe and the overlying probe for a few seconds to 1 minute or until readings stabilize. The valve on the top of the pumped probe should then be shut off, and the pump moved to the next shallower probe, with the procedure being repeated until all seals have been tested. The monitoring of vacuum at the probes above and below the pumped probe should include the maximum vacuum attained, as well as the rate of the response.

## **D.10 Documentation**

A soil gas probe installation log form is attached. One form should be filled out for each soil gas probe installation. The volume of air removed during development should be recorded, as well as the stable flow rate and vacuum. A log of geologic material properties should also be prepared, using a standard borehole logging template.

## **D.11 References and Additional Reading**

American Petroleum Institute (API), 2004. *Collecting and Interpreting Soil Gas Samples from the Vadose Zone: A Practical Strategy for Assessing the Subsurface-Vapor-to-Indoor-Air Migration Pathway at Petroleum Hydrocarbon Sites*, Final Draft, October 2004.

ASTM (American Society for Testing and Materials). 1992. *Standard Guide for Soil Gas Monitoring in the Vadose Zone*. D5314-92, Vol. 04.08. West Conshohocken, PA.

Barcelona, MJ, JP Gibb, and RA Miller. 1983. *A Guide to the Selection of Materials for Monitoring Well Construction and Ground-Water Sampling*. Illinois State Water Survey Contract Report 327; USEPA-RSKERL, EPA-600/52-84-024, 78 pp.

BP (British Petroleum). 1998. *SPP-110 Vadose Zone Sampling at BP Corrective Action Sites*. Global Environmental Management, a BP Affiliated Company. Lisle IL.

California Department of Toxic Substances Control (DTSC), 2004. *Interim Final Guidance for the Evaluation and Mitigation of Subsurface Vapor Intrusion to Indoor Air*, December 15, 2004.

CRWQCB (California Regional Water Quality Control Board – Los Angeles Region) and the Department of Toxic Substances Control (DTSC). 2003. "Advisory – Active Soil Investigations." January.



- CSDDEH (County of San Diego, Department of Environmental Health). 2003. *Site Assessment and Mitigation Manual (SAM Manual 2002)*. San Diego, CA. January 22.
- Devitt, D.A., R.B. Evans, W.A. Jury, T.H. Starks, B. Eklund, and A. Gholson. 1987. *Soil Gas Sensing for Detection and Mapping of Volatile Organics*. EPA/600/8-87/036. U.S. EPA-EMSL. Las Vegas, NV.
- Eklund, B. 1985. *Detection of Hydrocarbons in Groundwater by Analysis of Shallow Soil Gas/Vapor*. American Petroleum Institute Publication No. 4394. May.
- Hartman, B. 2002. "How to Collect Reliable Soil-Gas Data for Risk-Based Applications, Part1: Active Soil-Gas Method." LUST Line Bulletin 42. October.
- Health Canada, 2004. Final Draft Report on Soil Vapour Intrusion Guidance for Health Canada Screening Level Risk Assessment (SLRA), Golder Associates Ltd. October 2004.
- Kerfoot, H.B., "Soil-Gas Surveys for Detection and Delineation of Ground-Water Contamination", Invited Paper, *Trends in Analytical Chemistry*, April, 1990.
- Lahvis, M.A. 2002. Guidance on Use of Soil-Gas Surveys to Assess Vapor Transport to Indoor Air. Shell Global Solutions (U.S.), Inc. Houston, TX.
- Marrin, D.L., and H. B. Kerfoot, 1988. "Soil-Gas Surveys", Feature Article, *Environmental Science and Technology*, August, 1988.
- Mayer, C.L., 1989, Draft interim guidance document for soil-gas surveying, U.S. Environmental Protection Agency Environmental Monitoring Systems Laboratory, Office of Research and Development, Contract Number 68-03-3245, 124 pp.
- Nelson, D. W., and L. E. Sommers. 1982. Total Carbon, Organic Carbon, and Organic Matter. In: A. L. Page et al. (editors), *Methods of Soil Analysis: Part 2 Chemical and Microbiological Properties*. ASA [American Society of Agronomy, Inc.] Monograph Number 9, p. 539 – 579.
- Robbins, G.A., Deyo, B.G., Temple, M.R., Stuart, J.D., and Lacy, M.J., 1990, Soil-gas surveying for subsurface gasoline contamination using total organic vapor detection instruments, Part I: Theory and laboratory experimentation, *Ground Water Monitoring Review*, 10, 122-131.
- San Diego DEH, 2003, Site Assessment and Mitigation Manual 2003, [http://www.sdcounty.ca.gov/deh/lwq/sam/manual\\_guidelines.html](http://www.sdcounty.ca.gov/deh/lwq/sam/manual_guidelines.html)
- USEPA. 1996. *Soil Gas Sampling*. Standard Operating Procedure No. 2042. Environmental Response Team. Washington, D.C. June.
- Wisconsin Department of Health and Family Services. 2003. Chemical Vapor Intrusion and Residential Indoor Air; Guidance for Environmental Consultants and Contractors. State of Wisconsin, Department of Health and Family Services, Division of Public Health. February 13, 2003.

Weeks, E.P., D.E. Earp, and G.M. Thompson, 1982. "Use of atmospheric fluorocarbons F-11 and F-12 to determine the diffusion parameters of the unsaturated zone in the southern high plains of Texas", *Water Resources Research*, v.18, 1365-1378.

## **D.12 Attachment 1: Recommended Equipment**

Mention of specific brand names and models does not constitute product endorsement. The suggested equipment can be substituted with equivalent equipment, but it is the responsibility of the user to ensure that substitute equipment meets the requirements.

**Tubing:** High Density Polyethylene (HDPE) tubing is generally acceptable for low sorption (Barcelona et. al., 1983), and works well with compression or barbed fittings. Nyla-Flow™ tubing is considered equally appropriate. Teflon™ tubing is considerably less flexible than HDPE and may not work as well with barbed fittings. Tubing may also be stainless steel or copper, which forms air-tight seals when used with Swagelock™ fittings, but is more expensive and less flexible than HDPE. Soft flexible tubing should be avoided (except for the discharge line from the pump discharge to an outdoor location, if used), because vapors tend to adsorb more strongly to them.

**Rotameter-Style Flowmeters:** Dwyer Model RMB-5-49 with a range up to 5 standard cubic feet per hour (SCFH) (2.4 L/min), and Model RMB-5-52 with a range up to 50 SCFH (24 L/min).

**Vacuum Gauges:** Dwyer Magnehelic™ gauges, which are available in several ranges, including zero to 0.25 in-H<sub>2</sub>O, zero to 5 in-H<sub>2</sub>O, and zero to 100 in-H<sub>2</sub>O.

**Vacuum Pump:** Gast, DOA-P101-AA piston pump

Suggested Operating Procedure: Soil Gas Probe Installation

SOIL GAS PROBE CONSTRUCTION



130 Research Lane, Suite 2  
Guelph, Ontario, Canada N1G 5G3  
(519)822-2230 Fax (519)822-3151

Well ID \_\_\_\_\_ Site Location \_\_\_\_\_  
Project Name \_\_\_\_\_ Field Personnel \_\_\_\_\_  
Project Number \_\_\_\_\_ Recorded By \_\_\_\_\_

Permit Number \_\_\_\_\_ Drilling Contractor \_\_\_\_\_  
Installation Date(s) \_\_\_\_\_ Driller \_\_\_\_\_  
Drilling Method \_\_\_\_\_ Drilling Fluid \_\_\_\_\_  
Borehole Diameter \_\_\_\_\_ Fluid Loss During Drilling \_\_\_\_\_ Litres/Gallons

**Materials Used**

Riser Pipe: Diameter \_\_\_\_\_ cm/inches  
Construction \_\_\_\_\_  
 PVC schedule \_\_\_\_\_  
 Stainless Steel  
 Other \_\_\_\_\_

Slotted Area: Length \_\_\_\_\_ cm/inches  
Diameter \_\_\_\_\_ cm/inches  
Slot Size \_\_\_\_\_ cm/inches  
Construction \_\_\_\_\_  
 PVC schedule \_\_\_\_\_  
 Stainless Steel  
 Other \_\_\_\_\_  
Silt Trap Used  Yes  No

Bottom End Cap:  Male  Female  Slip  
 PVC  
 Stainless Steel  
 Other \_\_\_\_\_

Top Cap:  Male  Female  Slip  J Plug  
 PVC  
 Stainless Steel  
 Other \_\_\_\_\_

Protective Casing: Length \_\_\_\_\_ cm/inches  
Diameter \_\_\_\_\_ cm/inches  
Construction  Cast Aluminum  
 Cast Steel  
 Other \_\_\_\_\_

Casing Installation: Length \_\_\_\_\_ metres/feet  
Diameter \_\_\_\_\_ cm/inches  
Material \_\_\_\_\_

Drain:  
Coarse Sand: \_\_\_bags of \_\_\_kg/lb per bag Size \_\_\_\_\_  
Pea Gravel: \_\_\_bags of \_\_\_kg/lb per bag Size \_\_\_\_\_

Sandpack:  
Coarse Sand: \_\_\_bags of \_\_\_kg/lb per bag Size \_\_\_\_\_  
Fine Sand: \_\_\_bags of \_\_\_kg/lb per bag Size \_\_\_\_\_

Seal:  
Bentonite Pellets: \_\_\_bags of \_\_\_kg/lb per bag Type \_\_\_\_\_  
Bentonite Slurry: \_\_\_bags of \_\_\_kg/lb per bag Type \_\_\_\_\_

Grout:  
Cement: \_\_\_bags of \_\_\_kg/lb per bag Type \_\_\_\_\_  
Bentonite: \_\_\_bags of \_\_\_kg/lb per bag Type \_\_\_\_\_

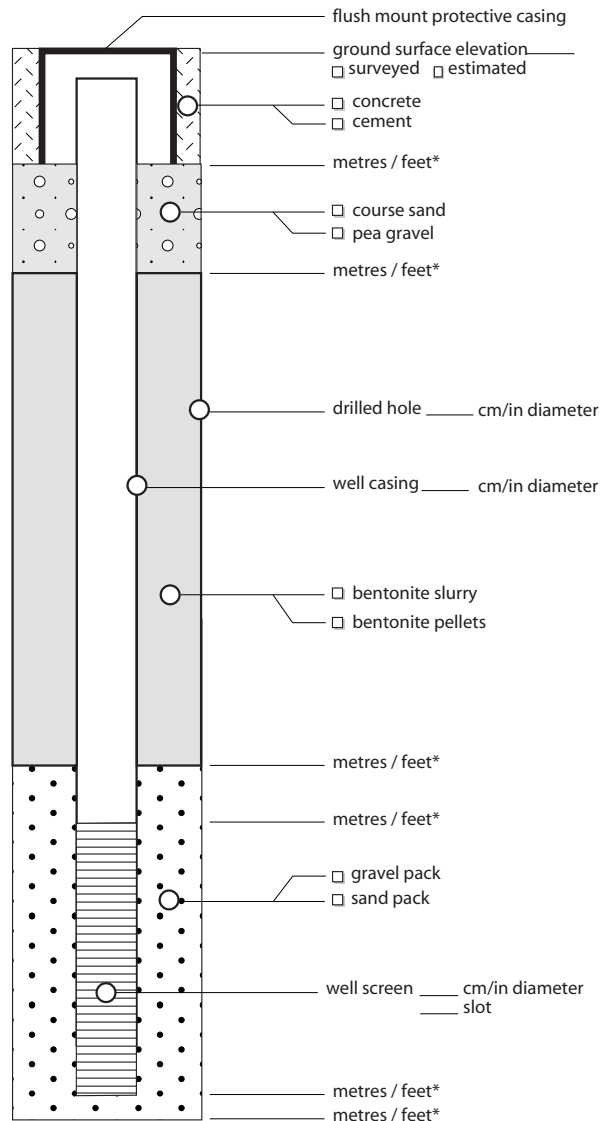

Measuring Point is Top of Well Casing  
Unless Otherwise Noted

\* Depth Below Ground Surface



# E

## SUGGESTED OPERATING PROCEDURE: SOIL GAS SAMPLE COLLECTION

---

### E.1 Introduction

Soil gas sample collection requires purging to flush stagnant gas from the soil gas probe prior to collection of a sample for laboratory analysis, much the same as purging stagnant water from a monitoring well prior to collection of a groundwater sample. Soil gas sampling for assessment of subsurface vapor intrusion to indoor air requires much lower detection limits than historic uses of soil gas sampling for assessing presence or absence of releases of volatile and semi-volatile organic chemicals (VOCs and SVOCs); therefore, soil gas sampling methods have evolved considerably in the past decade. This protocol is intended to provide representative and reproducible samples with documentation via field screening readings and pneumatic (flow and vacuum) data gathered during the purging and sample collection process.

The most common sources of bias in soil gas sampling are leaks that allow atmospheric air to enter the sample (typically imparting a negative bias), or desorption of vapors from equipment that was previously used for sampling in an area of higher soil gas concentrations (positive bias). Variability can occur naturally due to weather conditions (temperature, rainfall, barometric pressure), or artificially due to inconsistent sampling procedures. This document specifies procedures for purging, sample collection, storage and handling to the degree needed to minimize artificial data bias and variability to the levels required when working with very low detection limits (<1 part per billion by volume [ppbv]).

### E.2 Static Pressure or Vacuum

Prior to sampling, the static vacuum or pressure in the soil gas probe should be measured and recorded. This is analogous to measuring a static water level in a groundwater monitoring well. These data can be used to assess whether and to what extent pressure gradients might influence soil gas flow (Auer, et. al., 1996, Carrigan et. al., 2000, Neeper, 2001, Parker, 2003, and Weeks, 1979).

To measure the static vacuum/pressure in the soil gas probe, connect a vacuum gauge to the valve at the top of the soil gas probe using tubing. Level and zero the gauge. Open the valve and record the average reading. Most gauges are capable of measuring vacuum or pressure by connecting to one of two ports, and it may be necessary to try both, in which case, the valve should be closed before disconnecting the tubing to avoid a potential for leakage. It may be necessary to shield the vacuum gauge from any wind, which can cause the readings to fluctuate.

Record the static pressure or vacuum, along with the date, time, temperature and weather conditions. A form for recording field data is attached.

In some circumstances it may be advantageous to record static pressure or vacuum over a longer period of time, for example a period long enough to include one or more cycles in atmospheric pressure. This may be accomplished using pressure transducers with data-logging capabilities. Most of these devices record gauge pressure (difference between soil gas pressure and atmospheric pressure), so a separate digital barometer is required to record absolute atmospheric pressure for interpretation of the gauge pressure data. Alternatively, this information may be obtained from local weather monitoring stations (e.g. airports) for a minimal fee. Micro-manometers, pressure transducers and data loggers are available from several manufacturers, and should be operated according to manufacturer's instructions.

### **E.3 Leak Checks**

All couplings and fittings in the sampling train (**Figure E-1**) should be checked for leaks after assembly in the field and before purging and sampling begins. It may also be appropriate to conduct a tracer test to assess whether atmospheric air is drawn into the probe during purging and sampling, particularly if the soil gas permeability is relatively low (indicated by the ratio of flow rate and vacuum, for example, if >10 inches of water column [in-H<sub>2</sub>O] vacuum is required to achieve a flow of 200 milliliters per minute [mL/min]), the probe tip is relatively shallow (<5 ft), or field screening readings of VOCs or CO<sub>2</sub> show decreasing concentrations in successive purge volumes, while O<sub>2</sub> concentrations increase toward atmospheric levels.

The sampling train can be leak-tested two ways:

1. a "shut-in" test, where the pump is used to exert a pressure or vacuum on the sampling train, then all valves are closed and the pressure or vacuum is observed over time to ensure it does not dissipate. A target vacuum or pressure level of 100 in-H<sub>2</sub>O is appropriate, to maximize the resolution of the observations, and the stress on the sample train. If the test is conducted using positive pressure, a soapy water solution can be used to identify leaks;
2. a mock sample collection of span gas from a Tedlar bag, where the Tedlar bag is filled with calibration gas (e.g. 50 ppmv hexane), and connected to a valve, which is opened only enough to allow the span gas to flow at a rate and vacuum similar to the flow and vacuum achieved during purging from the soil gas probe (mimicking the resistance imposed by the soil gas permeability). If a field screening reading of the sample collected by this method has a concentration lower than the span gas, a leak is indicated.

If either of the above tests of the sampling train indicates a leak, the connections should be disconnected and carefully reconnected one at a time until the leak is corrected, with repeat leak testing of each connection in turn.

The probe seal can be leak tested by injecting a tracer gas into a shroud around the top of the soil gas probe, and measuring the concentration of the tracer in the shroud and the soil gas sample. Ideally, the sample will contain <5% of the tracer gas concentration in the shroud, indicating that the sample is >95% representative of subsurface gas. It may be feasible to use the tracer gas to perform a mass balance calculation to correct for any atmospheric air dilution that may be

significant, retrofit the probe by installing additional seal materials, or it may be preferable to install a new probe and take extra care with the seal placement.

The shroud can consist of a clear plastic container (e.g. large Tupperware™ container) or a clear plastic sheet large enough to surround the soil gas probe and valves and fittings at the top of the probe. One hole in the shroud is required to allow ¼-inch high-density polyethylene (HDPE) or Nylon tubing to extend from the probe inside the shroud to the lung-box outside the shroud. Ports for tracer gas injection and monitoring are also helpful.

The recommend tracer gas is helium because it is non-toxic, readily available (toy stores and party supply stores), inexpensive, easily measured using portable detectors available for rental with 4 orders of magnitude ranges in readings, and generally not present in the subsurface at concentrations that might interfere with the test. Injecting helium from a pressurized cylinder for several seconds will generally be sufficient to create concentrations in the shroud in the range of 10% to 50% by volume. The air under the shroud should be screened with the portable monitoring device after adding the tracer, which can be done through a small hole in the shroud. Purging into a Tedlar bag in the lung box yields a soil gas sample that should also be screened using the helium meter to confirm the absence of any significant leaks. Other tracer gases may be used (e.g. isobutylene, butane, propane, sulphur hexafluoride [ $\text{SF}_6$ ]), providing a field screening reading is available that can provide at least two orders of magnitude range, and the selected tracer is not present in the subsurface at levels that might pose an interference. The ionization potential of butane and propane is higher than most photoionization detector (PID) lamps, so a flame ionization detector (FID) would be required, and a mobile gas chromatograph would be required to provide unequivocal results.

#### **E.4 Flow and Vacuum Check**

A simple test of soil gas flow and vacuum should be conducted after seals are set. Analysis of this data can be used to calculate the gas permeability of the subsurface materials. If the result is a much lower permeability than expected, this test may provide valuable information about possible plugging of the soil gas probe. Periodic checks (e.g. at the beginning of each sampling event) can be used to demonstrate consistency in the pneumatic conditions at the probe, which may also be informative.

Soil gas samples for field screening or laboratory analysis typically require a volume of approximately 1 to 6 liters (L). Sample collection over 10 minutes to 1 hour is a reasonable period of time; therefore, a reasonable flow rate should be at least 100 mL/min. The flow rate will be proportional to the applied vacuum. Excessive vacuum can change the partitioning of vapors between pore water and soil gas; therefore, it should be avoided. Excessive vacuum will also increase the risk of leakage at the connection between the probe and the sample container, which can result in sample bias by the ingress of indoor air. Vacuum levels less than 1 to 10 in- $\text{H}_2\text{O}$  should be low enough to avoid both concerns. Higher-level vacuum may be acceptable, but should be recorded and discussed with the data interpretation. Where a flowrate of at least 100 mL/min cannot be sustained with a vacuum less than 100 in- $\text{H}_2\text{O}$ , the sample should not be collected, or the resulting data should be appropriately qualified.

To measure the soil gas flow and corresponding vacuum, connect a “T”-fitting to the valve at the top of the soil gas probe using ¼-inch tubing. Connect a vacuum gauge to one end of the “T” fitting and a rotameter-style flowmeter to the other. Connect the vacuum pump to the rotameter. Open the soil gas probe valve. With the valve at the inlet of the pump closed, start the pump, and gradually open the valve until there is a measurable flow. Preferably about 100 mL/min. The vacuum should stabilize almost instantaneously. Record the flow and corresponding vacuum. Increase the flow to a higher level, preferably about 500 mL/min, and record the steady flow. This test requires no more than 1 minute of pumping, and will remove less than ½ L of soil gas, so no unacceptable bias to the soil gas chemistry will be posed.

The data will be analyzed using the method of Johnson, et. al., 1990, equation 11, which is as follows:

$$Q = H * \left[ \frac{(k * \pi)}{\mu} \right] * P_w * \frac{\left[ 1 - \left( \frac{P_{ATM}}{P_w} \right)^2 \right]}{\left[ \ln \left( \frac{R_w}{R_I} \right) \right]}$$

Where, Q = Standard Vapor Flowrate at Wellhead (m<sup>3</sup>/s)

H = Well Screen Length through Vadose Zone (m)

k = Permeability (m<sup>2</sup>)

π = 3.1416

μ = Dynamic Viscosity (typically 1.8 x 10<sup>-5</sup> kg/m-s for air at STP)

P<sub>w</sub> = Absolute Pressure at Wellhead (P<sub>ATM</sub> minus wellhead vacuum, kg/m/s<sup>2</sup>)

P<sub>ATM</sub> = Atmospheric Pressure (about 1.01 x 10<sup>5</sup> kg/m/s<sup>2</sup>)

R<sub>w</sub> = Radius of Well (m)

R<sub>I</sub> = Radius of Influence (ROI) (estimated, typically 1 to 10 m)

The ROI is not uniquely determined from this test, so it must be estimated. Fortunately, the solution is not particularly sensitive to the ROI value chosen, so this estimation does not impose significant uncertainty in the test results. For tests of this nature, where flow and vacuum are maintained at modest levels, the ROI should be on the order of 1 to 10 meters. It is recommended to calculate the permeability using more than one ROI value to demonstrate the uncertainty imposed by this estimated value.

Rearranging the equation above to solve for permeability results in the following equation:

$$k = \left( \frac{Q}{H} \right) * \left( \frac{\mu}{\pi} \right) * \frac{\left[ \ln \left( \frac{R_w}{R_I} \right) \right]}{\left[ P_w * \left\{ 1 - \left( \frac{P_{ATM}}{P_w} \right)^2 \right\} \right]}$$



## **E.5 Soil Gas Probe Purging**



Soil gas sampling requires purging prior to sample collection in order to ensure the sample is representative of soil gas contained within the geologic materials outside the soil gas probe and filter sand surrounding the soil gas probe screen. Excessive purging may reduce the resolution in vertical profiles of concentrations measured for samples from multi-level or nested soil gas probes. In the extreme case, excessive purging may result in dilution of the soil gas sample with atmospheric air, although this is seldom a concern for probes of 2-inch diameter or less, unless the screened interval is very shallow (less than a few feet). Generally, a larger purge volume increases the representative elemental volume of the sample, and reduces artifacts of small-scale spatial variability. Purging more than 10 probe volumes (the internal volume of the probe itself) is seldom necessary to collect a representative sample, and should only be done if steps are taken to address the potential for atmospheric air entry. For a ¼-inch probe of 5 ft depth, 10 casing volumes is a total volume of only ½ liter (L). In a porous media with a 30% air-filled porosity, ½ L of soil gas is contained within a sphere about the size of a softball. Purging of such a small volume of gas is unlikely to cause unacceptable atmospheric air entry in most circumstances. Field screening with a PID, FID, oxygen (O<sub>2</sub>), carbon dioxide (CO<sub>2</sub>), and methane meters may require as much as 1 L of soil gas per set of measurements. If a minimum of three measurements of field parameters is desired to assure stabilization prior to sample collection, then the total purge volume prior to sampling may be 3 L, and a subsequent sample for laboratory analysis may be another 1 L. A total of 4 L of soil gas can be contained within a sphere of soil a little larger than a basketball, which will not be excessive in most cases. For deeper probes, a larger volume of gas can be purged without causing excessive mixing of soil gas from different intervals. For example, a 1-inch diameter probe 10 feet deep has a probe volume of about 1.5 L. Three to five casing volumes can be withdrawn during purging and sampling without drawing gas from farther than about 1 foot from the probe tip.

If the soil gas probe is located inside a building and if indoor air sampling is also planned as part of the scope of work, purged soil gas should not be directly vented into the air inside the building because it may contribute a positive bias to the indoor air samples. The outlet of the vacuum pump used with the lung box should be routed through a tube to an outdoor location. Any soil gas remaining in the Tedlar bag after screening should be evacuated using this pump, prior to collection of subsequent bag samples.

Soil gas purging is performed using a Tedlar™ bag and lung box apparatus, as shown on **Figure E-1**. The Tedlar bag is placed inside the lung-box and connected to the soil gas probe using a new and disposable length of HDPE, Nylon or Teflon™ tubing. The tubing should be as short as practicable to minimize the dead volume of the tubing. The Tedlar bag is sealed inside the lung box and a pump is used to evacuate the region inside the lung box and outside of the Tedlar bag. With the valves on the Tedlar bag and on top of the soil gas probe both in the open position, evacuating the lung box will induce soil gas flow from the probe into the Tedlar bag. This sample collection technique prevents flow through a pump, which could cause sample contamination. The Tedlar bag should be filled with sufficient volume of soil gas for field screening using portable instruments (described below). The valve on the top of the soil gas probe must be closed before disconnecting the Tedlar bag and conducting the field screening. Otherwise, there may be residual negative pressure in the soil gas that can draw atmospheric air back into the probe, and cause a potential negative bias for subsequent screening.

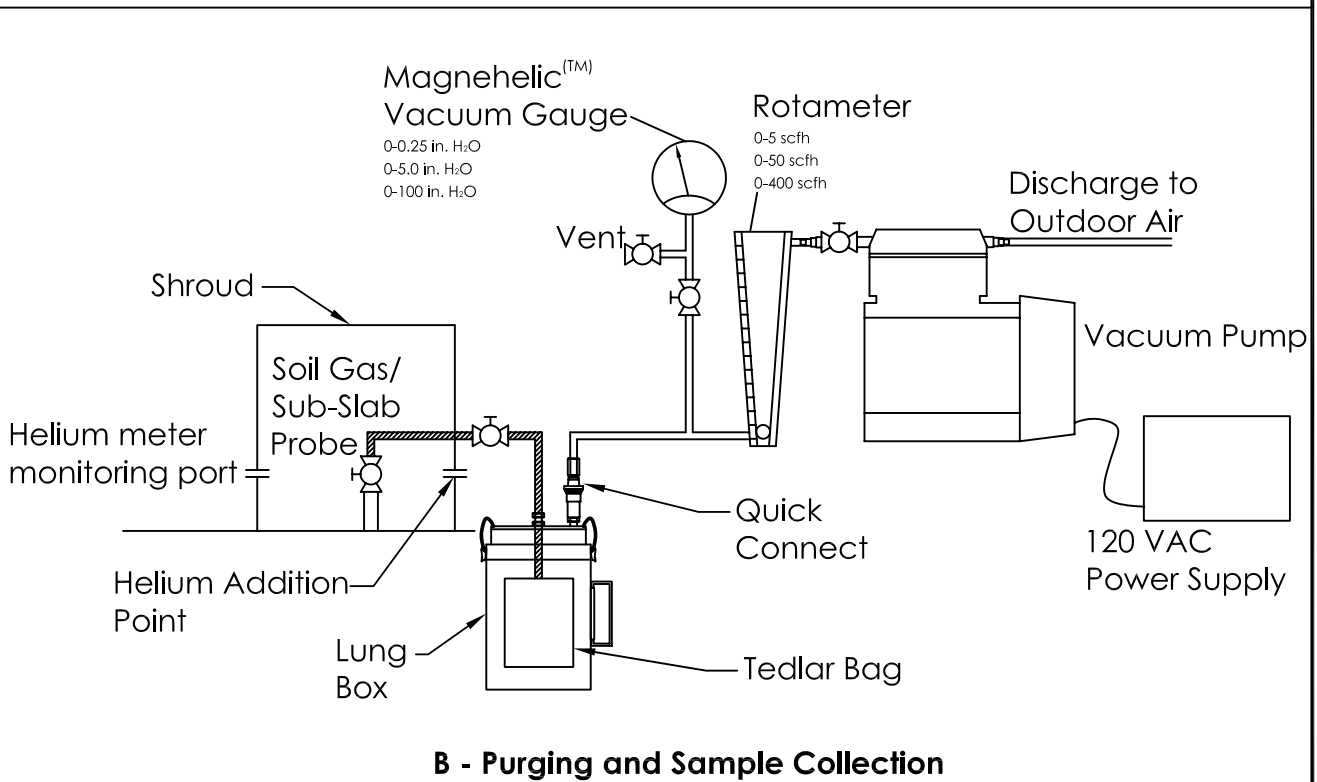
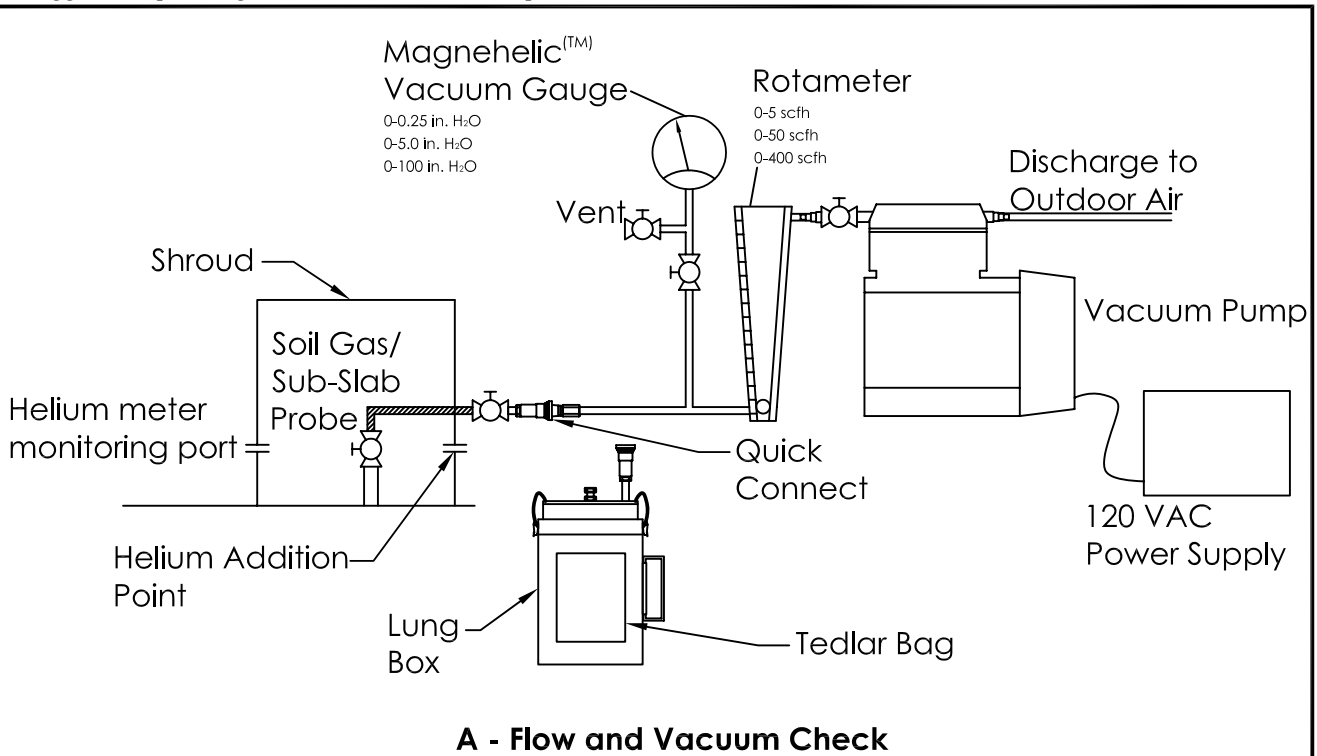
Suggested Operating Procedure: Soil Gas Sample Collection



-  High Density Polyethylene Tubing (HDPE), Nylaflo, Teflon, Stainless Steel
-  Low Density Polyethylene Tubing (LDPE)

**Soil Gas Sampling Apparatus**

Jan. 2005

Figure: E-1



Tedlar bags are available in various volumes, ranging from 0.5 L to 10 L, but generally, either 1 L or 3 L bags are appropriate. If the sampling program proceeds from soil gas probes with low concentrations to probes with higher concentrations, it may be acceptable to re-use Tedlar bags, after flushing several times with atmospheric air. However, it is necessary to use dedicated or new bags to reduce the potential for cross-contamination between samples if subsequent laboratory analyses are planned via sub-sampling out of the Tedlar bag, as described below.

After screening, the Tedlar bag should be emptied and the purging process repeated until the volume of soil gas removed from the probe is greater than the dead-volume of the probe, plus the porosity of the sand filter pack around the screen of the soil gas probe at a minimum. Generally three to five probe volumes is sufficient to achieve steady readings on the portable instruments and provide sufficient documentation for a third-party data quality review.

Vacuum and flow rate should be monitored during purging, using the apparatus shown in **Figure E-1**. In moderate to high-permeability soils, a soil gas flow rate in the range of 200 to 2,000 milliliters per minute (mL/min) can be achieved with a vacuum of less than 10 in-H<sub>2</sub>O. Flow rates and vacuum in these ranges are not likely to cause bias on sample concentrations, although lower flow rates may be required by local regulatory agencies in some areas. Excessive vacuum can induce volatilization and cause a positive bias in sample concentrations, as well as increase the risk of leaks. Low flow rates increase the residence time of the soil gas in the sample train and can lead to biases attributable to interactions with the sampling materials. If the geologic materials have low gas permeability, higher vacuum levels will be required to achieve acceptable flowrates. If a vacuum greater than 100 in-H<sub>2</sub>O is required to generate a flow of 0.1 L/min, it is questionable whether a soil gas sample can be collected by advection without disturbing the local equilibrium phase partitioning between the solid, liquid and gas phases, and any sample collected under such conditions should be qualified at a minimum.

The soil gas probe vacuum should be measured during purging by connecting a vacuum gauge to a “T” fitting connected to the sampling train. The flowrate during purging should be controlled by moderating the vacuum applied to the lung box to fill the 1L Tedlar bag at a rate not to exceed 2L/min (i.e. 1L Tedlar bag filled in 30 seconds). Vacuum levels less than 10 in-H<sub>2</sub>O are preferred, and vacuum > 100 in-H<sub>2</sub>O should be avoided. The flow rate and corresponding vacuum should be recorded on the attached form. When multiple sampling events are planned, the consistency of the ratio of flow divided by the applied vacuum should be assessed to qualitatively evaluate the pneumatic conductivity, which should remain relatively constant for a given probe over time. Significant increases in flow may indicate a leak in the sample train.

## **E.6 Field Screening**

Field screening of total VOC vapor concentrations is conducted during purging to verify stable readings before collection of soil gas samples for laboratory analysis. Stable readings will typically be defined as reading that vary by less than 10% from previous readings and show no consistent trend in either increasing or decreasing concentrations.

Samples of the extracted soil gas should be collected for field screening using a portable FID or PID after every purge volume removed (or 1 L if the purge volume is smaller). The FID or PID

should be calibrated according to manufacturer's instructions to a span gas (i.e. isobutylene or hexane) of known concentration (typically 50 or 100 ppmv) and to zero gas (in areas of poor outdoor air quality) or ambient outdoor air, immediately prior to use. The calibrations should be confirmed several times during the day to assess potential instrument drift. If the readings show more than 10% drift against the standard gas, or more than +/- 1 parts per million by volume (ppm<sub>v</sub>) of zero gas or ambient air, the instrument should be recalibrated. The FID or PID reading will be made by connecting the Tedlar bag to the instrument and allowing the instrument to draw a sub-sample at ambient pressure (the bag must not be squeezed because this can cause a bias in the calibration). The time and the steady reading are recorded.

Samples of soil gas may also be screened for concentrations of carbon dioxide (CO<sub>2</sub>), oxygen (O<sub>2</sub>), and methane (CH<sub>4</sub>), using a landfill gas meter, particularly if the VOCs of concern are susceptible to natural biodegradation under aerobic conditions (e.g. hydrocarbons). Readings should be made by connecting the Tedlar bag to the instrument and allowing the instrument to draw a sub-sample at ambient pressure. The instrument should be calibrated according to manufacturers instructions. The time and the steady reading are recorded. Ambient air readings should also be recorded.

Between readings, the instruments should be confirmed to return to ambient levels, and not display any indication of sample carry-over.

## **E.7 Collection of Samples for Laboratory Analysis**

Soil gas samples for laboratory analysis should be collected in Summa™ canisters or via adsorption onto Automatic Thermal Desorption Tubes (ATD tubes), provided by the analytical laboratory. Summa™ canisters are stainless steel vessels with a fused silica passivated inner surface that facilitates complete recovery of most VOCs. They are widely available in 6 L volume, but are also available in 1L “mini-Summa canister” size, which is easier to ship and handle, and is capable of providing sufficient sample for analysis with standard TO-15 reporting limits (0.5 ppbv). The added advantage of the mini-Summa canister is that it can be used to draw a sample from a 1L Tedlar bag, without exceeding the capacity of the bag, or requiring multiple bags for a sample. Collecting a mini-Summa canister sample from a Tedlar bag allows an opportunity for field screening the residual volume of the Tedlar bag after the mini-Summa canister collection, which can be compared to the field screening data collected during purging to provide assurance that the sample drawn into the mini-Summa canister is directly comparable to the steady purging soil gas quality. The size of the Tedlar bag will depend on the size of the Summa canister used and the volume of gas need for field screening readings, but generally a 3 L Tedlar bag is ample for a 1L Summa canister sample and field screening for VOCs, O<sub>2</sub>/CO<sub>2</sub> and possibly tracers such as helium. Sub-sampling from a Tedlar bag is not recommended for ATD tube samples, which are generally preferred when SVOCs are the compounds of interest. This is because Tedlar bags may not be sufficiently inert to adsorption of SVOCs.

### **E.7.1 Summa Canisters**

Summa canisters are cleaned in the laboratory and evacuated to typically 25 to 30 inches of Hg vacuum. The initial vacuum is confirmed prior to sampling by removing the Swagelock™ cap,

attaching the vacuum gauge securely (1/4-turn past snug), and opening the Summa canister valve. The Summa canister valve will then be closed and the vacuum gauge disconnected. The initial vacuum will be recorded on the attached form.

A new 5-micron stainless steel particulate filter is then connected to the Summa canister, which is then connected to the Tedlar Bag sample using as short as possible length of new and disposable HDPE tubing or stainless steel compression fittings to minimize dead volume. The valve on the Summa canister should be opened slowly to draw about 2/3rds of the volume of the Tedlar bag into the canister, then closed tightly. A 1L Tedlar bag works well with mini-Summa canisters, and 3L Tedlar bag works well with 6L Summa canisters. Note that the particulate filter provides some resistance to flow, which is desirable; otherwise, the Summa canister vacuum would extract the entire contents of the Tedlar bag nearly instantaneously, which is not desirable, because the risk of a leak increases if the Summa canister draws a vacuum against an emptied Tedlar bag.

After the sample is collected, remove the particulate filter and replace securely with the vacuum gauge, after which the mini-Summa canister valve should be re-opened, and the vacuum measured and recorded. This reading will also be confirmed upon receipt of the mini-Summa canister by the laboratory to ensure sample integrity during shipping. The mini-Summa canister valve should be closed before the vacuum gauge is removed, and the Swagelock™ cap should be securely replaced prior to shipping.

The remaining contents of the Tedlar bag should be screened immediately after the collection of the mini-Summa canister. If the screening reading is different than the steady field screening readings at the end of the purging process by more than 10%, this should be noted and an appropriate correction should be considered during data interpretation. If the screening reading is different than the steady field screening readings at the end of the purging process by more than a factor of 10, the mini-Summa canister sample should not be analyzed and the purging and sampling procedure should be repeated.

Summa canister samples may also be collected after purging is complete by connecting the Summa canister directly to the soil gas probe, with 5-micron filter and flow controller in line. The flow controller should be set for a flow rate of about 100 to 1,000 mL/min, depending on the volume of the Summa canister and soil gas permeability. A 6L Summa canister would take almost an hour to fill at 100 mL/minute, which is slow enough to have an effect on the cost of a sampling program. However, the flow rate should not be increased to the extent that it cause significant vacuum in the probe (preferably less than about 10 in-H<sub>2</sub>O). This may be difficult to predict in advance if the soil type is not known. Flow controllers are pre-set in the laboratory prior to shipment, so sampling by directly connecting a Summa canister to a soil gas probe may be difficult to design for investigations of sites where the soil gas flow and vacuum rates are not known in advance.

### **E.7.2 ATD Tubes**

ATD tube sampling requires an estimate of subsurface compounds and concentrations to select the appropriate adsorbent materials, flow rate and sample volume to avoid elevated detection limits or breakthrough. Assuming this information is generally limited or not available in

advance, the sample flow rate and volume may need to be adjusted in the field, depending on the results of the FID or PID screening. This requires input from an experienced analytical chemist, and considerations for possible ranges of site conditions should be discussed and agreed in advance, preferably being incorporated into the sampling and analysis plan.

ATD tube samples should be collected by connecting the ATD tube directly to the soil gas probe using a new piece of disposable HDPE or nylon tubing and compression fittings. In general, it is usually preferable to connect two ATD tubes in series, in case the mass of vapors extracted from the soil gas probes is sufficient to cause breakthrough, in which case the second tube can be analyzed and the concentrations estimated from the sum of the mass on the two tubes. The personal sampling pumps for ATD tubes are generally calibrated in the lab, but once connected to a soil gas probe their flow rate might be reduced if the soil gas permeability is moderate to low. Therefore a high-precision rotameter should be used to verify the flow rate, and either extend the sample period if needed to achieve the target sample volume, or adjust the pump to achieve the target flow rate.

Upon completion of sampling, turn off the pump, close the soil gas probe valve, disconnect the ATD tubes and secure their caps on either end.

## **E.8 Chain of Custody and Sample Handling**

The label tag on the mini-Summa canister should be filled-out with the site name, sample ID #, sampler's name, project code, date and time of sample, initial and final vacuum levels, and analysis requested. A chain of custody (COC) form should be completed with each sample shipment. The COC should include the sample ID, ATD tube or canister number, flow regulator ID number (if used), analysis requested, flow rate and sample duration for ATD tubes, and any special instructions. The laboratory will confirm the vacuum level for each Summa canister upon receipt to verify that the Summa canister valve and cap did not leak during shipment. Canisters and ATD tubes do not need to be refrigerated, but should be shipped with sufficient padding to prevent damage if the container is accidentally dropped.

The COC form should be signed by the sampler and placed in the shipping container, then the shipping container should be wrapped securely using packing tape. The sampler should sign the packing tape across the seam of the lid of the container, so it cannot be opened without damaging the signature. Upon arrival, the laboratory will confirm the signature to be intact, and complete the COC form. Analyses should be scheduled with the analytical laboratory to be completed within acceptable holding times. Summa canisters should be analyzed within 2 weeks. ATD tubes with compression-fit caps are stable for a very long time, but analysis should nevertheless be completed within less than 2 weeks.

## **E.9 Field QC Samples for Soil Gas Sample Collection**

Field quality control (QC) samples should be collected to monitor sampling and analytical performance. A complete record of all QC samples collected must be maintained as a part of the sampling documentation. The definition and purpose of each type of QC sample, and the procedures for their collection and handling are described in the paragraphs below.

**Ambient Air Screening:** Before field screening at each soil gas probe, an ambient air sample will be screened by drawing ambient air into a PID or FID over a period of at least one minute and recording the range of readings occurring during that time period. This ambient air screening should provide no detectable concentrations, but any readings observed may be useful to identify background conditions and evaluate potential biases.

**Equipment Blanks:** Prior to purging, an equipment blank should be performed to ensure the absence of measurable VOC vapors. Disconnect the tubing from the valve on top of the soil gas probe, and fill the Tedlar Bag with zero gas (preferred) or outdoor air through the tubing. Equipment blank readings should be made using a PID or FID, calibrated to span gas and zero gas according to manufacturer's instructions. Atmospheric air may be used as zero gas in areas of generally good air quality, but should be avoided in high traffic areas, smog areas, or areas with any noticeable odors. If the equipment blank reading is above the FID or PID detection limit, repeat the equipment blank step with a new Tedlar bag and new length of tubing. If this does not result in a blank with no detectable VOCs, the FID or PID calibration should be repeated and the equipment blank process repeated. If this still does not provide an equipment blanks below the FID or PID detection limit, a project management decision will be required regarding whether to proceed with sampling, or whether to replace or perform service on the FID or PID.

**Field Duplicate Sample:** During the soil gas probe sampling, a field duplicate sample will be collected using regular sampling procedures immediately after collecting the investigative sample. The field duplicate sample will be analyzed to identify sample variability. The duplicate sample will be submitted for analyses without indication of which sample the duplicate represents (i.e., blindly). If the monitoring program includes multiple samples (i.e. Summa canister for VOCs, ATD tube for SVOCs, possibly Radon, etc.), the duplicate should also include the entire suite. Field duplicate samples are recommended at a frequency of one for every 10 investigative samples.

**Trip Blanks:** Trip blanks are Summa canisters or ATD tubes that are shipped with other samples from the laboratory to the field site and back without a sample being collected. Their analysis should not detect any chemicals, but if there are potential contaminants encountered during the trip, the trip blank will identify them.

**Blanks and Blind Blanks:** A laboratory can analyze a Summa canister filled with ultra-high purity nitrogen (UHPN), to test for potential fugitive contaminants in the laboratory, or carry-over in the canister from previous samples; however, the Summa canisters have engraved serial numbers, so this is not a "blind" blank. For a blind blank, the laboratory can provide a Summa canister filled with UHPN, which can then be connected to another Summa canister with swagelock fittings to enable the blank sample to be truly anonymous (i.e. "blind").

## **E.9 Equipment Cleaning**

New or dedicated materials are preferred to minimize the risk of cross-contamination or carry-over from one sample to the next. The Tedlar bag may be re-used for field screening, but should be flushed using atmospheric air and completely drained three times between uses and verified clean by the equipment blank procedure. New or dedicated Tedlar bags are necessary if a

Summa canister sample is to be drawn from a Tedlar bag after field screening. Brass and stainless steel valves should be heated and flushed with ample amounts of air to strip any residual VOCs between sampling events.

## **E.10 Documentation**

Field documentation will include instrument calibration information; date, time and location of readings; purging rate and vacuum induced; number of Summa canisters filled; canister and flow controller ID numbers, sampler's name; and a detailed description of the equipment set up for each location. The series of field screening readings will be recorded on the sampling log sheets. A list of the soil gas probes sampled and the sampling order for all samples and QA/QC samples will be recorded on the sampling field records. Photographs are recommended to aid in recording equipment set-up.

For each sampling day, the following information will be recorded on the daily field logs

- name and number of project;
- name of field personnel;
- date and time of sampling event;
- list of the primary activities performed;
- identification of probes screened;
- time when soil gas samples were collected; and,
- all related information (weather, attendees, equipment problems, any departures from standard procedures and the reasons and responses) observed throughout the day.
- Field instrument information and calibration data;
- Value of probe dead space volume for each soil gas probe;
- Time, probe soil gas readings (and tubing blank reading) for each probe volume (or Tedlar™ bag filled); and
- Time and reading for each instrument calibration check.

## **E.11 References and Suggested Reading**

American Petroleum Institute (API), 2004. *Collecting and Interpreting Soil Gas Samples from the Vadose Zone: A Practical Strategy for Assessing the Subsurface-Vapor-to-Indoor-Air Migration Pathway at Petroleum Hydrocarbon Sites*, Final Draft, October 2004.

American Society for Testing and Materials (ASTM), 1992, Standard guide for soil gas monitoring in the vadose zone, ASTM D 5314-92, *American Society for Testing and Materials*, West Conshohocken, Pennsylvania, Annual Book of ASTM Standards, v. 04:09.

Auer, L.H., N.D. Rosenberg, K.H. Birdsell, and E.M. Whitney. 1996. *The Effects of Barometric Pumping on Contaminant Transport*. *Journal of Contaminant Hydrology*, 24:145-166.



- British Petroleum (BP). 1998. SPP-110 Vadose Zone Sampling at BP Corrective Action Sites. Global Environmental Management, a BP Affiliated Company. Lisle IL.
- Carrigan, C.R., S.A. Martins, A.L. Ramirez, W.D. Daily, G.B. Hudson, J.J. Nitao, B. Ekwurzel, and D. Ralston. 2000. *Characterization of Contaminant Transport by Gravity, Capillarity and Barometric Pumping in Heterogeneous Vadose Zones*. UCRL-ID-142784, Lawrence Livermore National Laboratory.
- Johnson, P.C., Kemblowski, M.W., and Colthart, J.D. 1990. Quantitative Analysis for the Cleanup of Hydrocarbon-Contaminated Soils by In-Situ Soil Venting. *GROUNDWATER*, Vol. 28, No. 3, May-June 1990.
- Neeper, D.A. 2001. A model of oscillatory transport in granular soils, with application to barometric pumping and earth tides. *J. Contam. Hydrol.* 48:237–252.
- Parker, J.C., 2003. Physical Processes Affecting the Natural Depletion of Volatile Organic Compounds in Soil and Groundwater, *Vadose Zone Journal*, 2:222-230 (2003)
- Posner, J.C., and W. J. Woodfin. 1986. Sampling with gas Bags I: Losses of Analyte with Time. *Appl. Ind. Hyg.*, 1(4):163-168.
- United States Environmental Protection Agency (US EPA), 2004. Standard Operating Procedure (SOP) for Installation of Sub-Slab Vapor Probes and Sampling Using EPA Method TO-15 to Support Vapor Intrusion Investigations, ORD, Ada, OK, DRAFT – February 12, 2004.
- United States Environmental Protection Agency (US EPA), 1999c. *Compendium of Methods for the Determination of Toxic Organic Compounds in Ambient Air – Second Edition*. (EPA/625/R-96/010b) Center for Environmental Research Information.
- United States Environmental Protection Agency (US EPA), 1997e, Expedited site assessment tools for underground storage tank sites: A guide for regulators, EPA 510/B/97/001, March 1997, Washington, D.C.
- United States Environmental Protection Agency (US EPA), 1996d. Soil Gas Sampling. Standard Operating Procedure No. 2042. Environmental Response Team. Washington, D.C., June 1, 1996.
- United States Environmental Protection Agency (US EPA), 1995b, SUMMA canister sampling, U.S. Environmental Protection Agency Environmental Response Team, Standard Operating Procedure 1704, July 27, 1995, Washington, D.C., 8 p.
- United States Environmental Protection Agency (US EPA), 1994a, Tedlar bag sampling, U.S. Environmental Protection Agency Environmental Response Team, Standard Operating Procedure 2102, October 10, 1994, Washington, D.C., 5 p.
- United States Environmental Protection Agency (US EPA), 1994d, Guidance for the Data Quality Objectives Process (EPA QA/G-4). Office of Research and Development, Document No. EPA/600/R-96/055. September 1994.
- United States Environmental Protection Agency (US EPA), 1992a. Air/Superfund National Technical Guidance Study Series: Assessing Potential Indoor Air Impacts at Superfund Sites. Office of Air Quality Planning and Standards. Research Triangle Park. North Carolina. Report EPA/451/R-92/002.

United States Environmental Protection Agency (US EPA), 1992c. *Guidance for Data Usability in Risk Assessment (Part A) Final*. (Publication 9285.7-09A PB92-963356) Office of Emergency and Remedial Response.

United States Environmental Protection Agency (US EPA), 1988a. EPA Guidance for Quality Assurance Project Plans. (EPA/600/R-E8/018).

Weeks, E.P. 1979. *Barometric Fluctuations in Wells Tapping Deep Unconfined Aquifers*. Water Resources Research, 15:1167-1176.

## **E.12 Attachment 1: Recommended Equipment**

Mention of specific brand names and models does not constitute product endorsement. The suggested equipment can be substituted with equivalent equipment, but it is the responsibility of the user to ensure that substitute equipment meets the requirements.

**Tubing:** High Density Polyethylene (HDPE) tubing is generally acceptable for low sorption (Barcelona et. al., 1983), and works well with compression or barbed fittings. Nyla-Flow™ tubing is considered equally appropriate. Teflon™ tubing is considerably less flexible than HDPE and may not work as well with barbed fittings. Tubing may also be stainless steel or copper, which forms air-tight seals when used with Swagelock™ fittings, but is more expensive and less flexible than HDPE. Soft flexible tubing should be avoided (except for the discharge line from the pump discharge to an outdoor location, if used), because vapors tend to adsorb more strongly to them.

**Rotameter-Style Flowmeters:** Dwyer Model RMB-5-49 with a range up to 5 standard cubic feet per hour (SCFH) (2.4 L/min), and Model RMB-5-52 with a range up to 50 SCFH (24 L/min).

**Vacuum Gauges:** Dwyer Magnehelic™ gauges, which are available in several ranges, including zero to 0.25 in-H<sub>2</sub>O, zero to 5 in-H<sub>2</sub>O, and zero to 100 in-H<sub>2</sub>O.

**Vacuum Pump:** Gast, DOA-P101-AA piston pump

**Lung Box:** Xitech Instruments, Inc. Model 1060 1 L Bag Sampler

**Helium Meter:** Mark 9822 helium detector

**Portable FID/PID:** Foxboro TVA 1000 FID/PID, ppbRAE, MiniRae 2000

**Personal Sampling Pump:** Sensidyne Gilian GilAir-3 Constant Flow Sampling Pump

**ATD Tubes:** supplied by laboratory, after discussion of target chemicals, relative concentrations, target detection limits, and potential ranges of concentrations.

# F

## SUGGESTED OPERATING PROCEDURE: SUB-SLAB SOIL GAS MONITORING

---

This document describes the suggested operating procedure (SOP) for sub-slab soil gas monitoring for the purpose of assessing the potential for subsurface vapor intrusion into indoor air. Sub-slab monitoring may include: subsurface gas sample collection for field screening and potential laboratory analysis, pneumatic monitoring to assess pressure differentials across the slab, and pneumatic testing to assess the gas permeability of the sub-slab materials. This SOP is intended to ensure high quality data collection and identify possible biases and ways that they can be avoided.

### F.1 Overview

Beneath most concrete floor slabs is a layer of granular fill material that is highly permeable and well-drained for structural purposes. This layer is normally also relatively permeable to soil gas, so in most cases, it is relatively simple to drill through the concrete floor and extract a sample of the sub-slab soil gas via vacuum for chemical analysis. Vapor intrusion assessments often benefit from collecting vertical profiles of vapor concentrations and O<sub>2</sub>/CO<sub>2</sub>, so this SOP includes a method for installation of deeper probes also.

In some cases, the slab may be poured directly over on natural geologic materials, which may have a low permeability that inhibits soil gas flow and make sample collection difficult. This condition can be assessed with a simple pneumatic test, which is included in this SOP.

Depending on building ventilation and barometric pressure fluctuations, air can flow from below the floor slab to indoor air, or vice-versa, or flow intermittently in either direction. Pressure differentials across the floor slab can be assessed by instantaneous or continuous monitoring methods, which are also described in this SOP.

### F.2 Probe Design and Installation

Sub-slab probes of two designs are described below. Type 1 probes (**Figure F-1**, after EPA, 2004) are installed into the concrete slab to directly monitor the sub-slab soil gas. Type 2 probes (also known as “through-slab” probes, **Figure F-2**) are installed and sealed below the sub-slab granular fill materials and into the underlying geologic materials. Both types of probes have an insert consisting of a brass or stainless steel pipe. For Type 1 (“sub-slab”) probes, the pipe does not extend beyond the bottom of the slab. For Type 2 (“through-slab”) probes, the pipe extends through the concrete slab and granular fill materials to a specified screened depth interval within the underlying geologic materials. Both types of probes have an air-tight fitting on the top that

allows a threaded cap to seal the pipe and are set flush with the floor surface to minimize any trip hazard. The cap should be secured any time the probe is not being used for monitoring. The cap is removed and replaced with a brass or stainless steel valve with male NPT threads on one side and a ¼-inch compression or barb fitting on the other side. All threaded couplings should be wrapped with Teflon™ tape to ensure air-tight seals.

Concrete floors are best drilled using a heavy-duty electrical hammer-drill. At least two different diameters of drill bits are required for Type 1 probes: ½-inch and 1-inch diameters. The ½-inch bit must be long enough to penetrate the floor slab (typically 6 inches, but occasionally up to 12 inches in industrial buildings). The 1-inch bit only needs to be a few inches in length.

Probe locations that are centrally located within areas of roughly 10 m by 10 m are generally recommended. This corresponds roughly to the footprint of a single-family residence. In large houses or commercial buildings, multiple samples may be appropriate to provide adequate assessment of spatial variability. The building owner should be consulted prior to deciding locations and which floor materials are acceptable to penetrate. Pre-tensioned concrete floors or subsurface utilities could be damaged by drilling or coring, so construction diagrams should be reviewed prior to selecting sample locations. Concrete dust generated during drilling should be collected during and after drilling using a wet/dry vacuum cleaner. If the floor is covered with carpet, a flap should be neatly cut with a sharp knife and lifted to access the concrete beneath, which can be secured after monitoring is complete with double-sided tape. If floor tiles are present, they should be cut with a tile-knife and lifted before drilling to avoid chipping to the extent practicable.

### **F.2.1 Type 1 Probes**

For Type 1 probes (**Figure F-1**), a ½-inch diameter hole should be drilled until it punctures the floor slab and barely enters the underlying granular fill materials, but should not continue into the underlying geologic materials. A significant increase in the rate of the drill-bit penetration or decrease in resistance will usually indicate the bottom of the slab. The upper few inches of the hole should be reamed using a 1-inch bit. Dust will fall into the ½-inch hole as the reaming progresses, so the ½-inch bit should be used to clear the hole to the bottom of the slab after reaming the upper few inches. Upon completion of drilling, reaming, and clearing, the insert should be installed and sealed promptly to minimize any potential air flow into or out of the drilled hole. If the insert is not installed immediately the drilled hole should be plugged using plastic food wrap, tightly wedged into the hole to form an air-tight seal. Do not use any kind of tape with adhesives that may give off vapors.

The probe insert will be set in the drilled hole through the concrete and grouted into place using a swelling cement, commonly referred to as hydro-cement (available at building supply stores and normally used to seal cracks in concrete foundations). This cement expands as it sets, to form a good seal. Do not use silicone sealants, caulking, or any other material that could potentially give off vapors. Hot glue may be used to seal the hole as long as only polyethylene glue is used. If the drilled hole diameter is large enough to allow the pipe to move freely, this may pose a risk that cement may flow down to the bottom of the pipe and plug the opening, in which case, wrap Teflon tape around the pipe near the bottom until it has sufficient diameter to contact the insides of the drilled hole tightly enough to prevent cement leakage past this “gasket”. Set the pipe so

that the threads are below the floor grade, and the cap is flush with the floor grade. The seal must be placed to allow the cap to be removed during monitoring events.

Cement seals should be allowed to set before sampling (typically less than an hour for fast-setting cement). If hot glue is used, the seal will set within minutes and can be sampled sooner.

### **F.2.2 Type 2 Probes**

Type 2 probes (**Figure F-2**) require a drilled or cored hole of sufficient diameter to allow a sand filter-pack and seal to be set within the annular space between the probe and the surrounding geologic material, otherwise, it will not be possible to verify that there is no annular leakage from the highly permeable sub-slab granular fill materials into the tip of the probe during purging and sampling. This will generally be difficult (and may be impossible) within holes that are drilled using a hammer-drill. Wherever possible, a nominal 2-inch diameter hole should be cored through the floor, and a soil coring device or hand-auger should be advanced to the target probe depth with removal of the soil core or cuttings prior to installation of the probe and annular backfill materials. For Type 2 probes, the lower few inches of the pipe should have openings, either drilled or cut with a clean hacksaw, so that the opening is not limited to just the bottom of the pipe, which could become plugged during installation if the geologic materials are clay-rich.

The granular fill materials beneath the floor slab are generally cohesionless, and may fall into the deeper borehole/corehole if the hole is left open; therefore, it is preferable to use a casing to prevent this where practicable. The void created by any such sloughing should be filled by the cement seal, to minimize any impact on the structural integrity of the slab, but for this reason, it is best to maintain a minimum of 1 foot separation between Type 1 and Type 2 probes installed in nested locations.

Options for Type 2 probes include multi-level installations, which will generally require a larger hole to be cored through the floor (e.g., 6-inch diameter), may require hand-augers or other means of drilling or coring a larger diameter hole through the subsurface materials, and a flush-mount casing surface completion. If multi-level probes are installed, the screened interval of each probe tip should be surrounded with filter sand and the intervals between probe tips should be backfilled with granular bentonite (bentonite with particles the size of coarse sand) and water, mixed in place with a tamping rod. The seals should be verified by pumping from each probe in succession with a minimum vacuum of 10 inches of water column (in-H<sub>2</sub>O), and monitoring vacuum in overlying and underlying probes. A faulty seal will transmit nearly all of the vacuum almost instantaneously, especially in low to moderate permeability geologic materials. If the seals are competent, vacuum will likely still be measurable, but it will be significantly less, and arrive much more slowly. Any questionable seals should be appropriately noted and sample data qualified accordingly. Otherwise, the installation can be abandoned and re-done.

High-density polyethylene (HDPE) or nylon tubing can be used for Type 2 probes, but rigid 1/4-inch diameter pipe (stainless steel, brass or copper) is recommended, because it facilitates installation of a replaceable cap completion, which minimizes trip hazards between monitoring events.

### **F.3 Measurement of Sub-slab Gauge Pressure/Vacuum**

The sub-slab gauge pressure/vacuum (pressure differential between indoor air and sub-slab gas) can be measured by connecting a valve to the probe insert, and attaching a vacuum gauge or digital micro-manometer. In either case, the vacuum gauge should be zeroed and leveled according to the manufacturer's instructions prior to testing, and the zero should be confirmed after disconnecting the instrument at the end of the measurement period. If the zero shows any measurable drift, a drift correction may be necessary.

In most cases, the ambient pressure differential will be very small (typically less than 10 pascals [Pa], 0.001 psi, or 0.03 in-H<sub>2</sub>O). Manometers and diaphragm gauges are generally not capable of recording these small pressure differentials. Digital micro-manometers have been developed specifically for this range of measurement. Digital micro-manometers can be programmed to integrate readings over a period of time to minimize fluctuations attributable to minor transient air currents.

Monitoring the ambient pressure differential from sub-slab to indoor air can be combined with monitoring of barometric pressure trends over time to assess whether and to what degree barometric pumping influences the sub-slab to indoor air pressure differential. Digital barometers are also available that record barometric pressure (and temperature) over time. Monitoring of this kind may help with interpretation of indoor air quality data, providing the micro-manometer, barometer, and indoor air sample collection periods are all coincidental.

A list of suggested monitoring devices is provided in **Attachment 1**. The suggested equipment can be substituted with equivalent equipment, but it is the responsibility of the user to ensure that substitute equipment meets the requirements.

## **4. Flow and Vacuum Check**

In most cases, the sub-slab materials are high-permeability granular fill materials, which yield soil gas under vacuum readily. However, a simple test can be conducted to confirm that the permeability of the sub-slab materials is sufficient to yield a representative sample in a reasonable period of time without excessive vacuum.

Soil gas samples for field screening or laboratory analysis typically require a volume of approximately 1 to 6 liters (L). Sample collection over 10 minutes to 1 hour is a reasonable period of time; therefore, a reasonable flow rate should be at least 100 millilitres per minute (mL/min). The flow rate will be proportional to the applied vacuum. Excessive vacuum can change the partitioning of vapors between pore water and soil gas; therefore, it should be avoided. Excessive vacuum will also increase the risk of leakage at the connection between the probe and the sample container, which can result in sample bias by the ingress of indoor air. Vacuum levels less than 1 in-H<sub>2</sub>O should be low enough to avoid both concerns. Higher-level vacuum may be acceptable, but should be recorded and discussed with the data interpretation. Where a flowrate of at least 100 mL/min cannot be sustained with a vacuum less than 10 in-H<sub>2</sub>O, it may be advisable to install and monitor an additional sub-slab probe to increase the confidence in the data.

To measure the soil gas flow and corresponding vacuum, the equipment should be assembled as shown on **Figure F-3**, and in the photograph below:



### **Soil Gas Flow and Vacuum Check Procedures**

Un-cap the probe and connect the monitoring attachment, which is comprised of a ball-valve with a ¼-inch compression fitting or hose barb. Attach the most sensitive vacuum gauge, open the valve and record the ambient pressure or vacuum reading, along with the date and time. The vacuum gauge should be leveled and zeroed prior to connecting the tubing.

Assemble the components of the soil sampling equipment in the configuration shown on **Figure 3** (Vacuum and Flow Check Arrangement). Use new ¼-inch diameter HDPE, Teflon™ or Nylon tubing. Rotameters and vacuum gauges of several different ranges should be available, to ensure accurate readings, regardless of the gas permeability of the subsurface materials, which can span several orders of magnitude (see equipment list in **Attachment 1**)

A “shut-in” test should be conducted to ensure that there are no leaks prior to starting the flow and vacuum check. With the probe valve closed, create a vacuum of 50 to 100 in-H<sub>2</sub>O within the sampling equipment apparatus by turning on the vacuum pump and then closing the ball valve on the influent side of the vacuum pump to maintain (i.e., “shut-in”) the vacuum. Observe the vacuum gauge for at least 1 minute and if the vacuum does not dissipate, proceed to step 4. Otherwise, adjust each connection until there are no measurable vacuum decreases.

Release the vacuum in apparatus by opening the vent adjacent to the vacuum gauge. After the vacuum has dissipated, close the vent and open the ball valve on the monitoring attachment. Connect the most sensitive vacuum gauge and rotameter initially, followed by the others in succession, only if vacuum levels go beyond the scale.

Ensure the top fitting of the rotameter is connected to the valve on the vacuum pump intake and the direction of air-flow through the rotameter is from bottom to top. Flow is controlled by a valve at the influent to the vacuum pump, and fine-tuning valves integral to the rotameters. Fully open the rotameter valve initially and fully close the valve at the inlet of the vacuum pump before starting the pump. Set the flow rate to slightly higher than 1 liter per minute (L/min) using the valve at the pump intake, then use the rotameter valve to reduce the flow to about 200 mL/min. The rotameters must be vertical to accurately measure flow.

Record the flow rate and vacuum level as soon as both stabilize (typically within seconds). Depending on the gas permeability of the subsurface materials, it may be necessary to change the vacuum gauge (i.e., replace zero-to-0.25 in-H<sub>2</sub>O gauge with zero-to-5 in-H<sub>2</sub>O gauge) to ensure that both flow and vacuum are clearly measurable within the scales of the vacuum gauge and rotameter. If so, the valve at the top of the probe should be closed before any changes are made, to prevent any vacuum induced in the sub-slab region from pulling air backward through the sampling train, and the “shut-in” test should be repeated to confirm the absence of any noticeable leak.

Increase the flow rate to about 500 mL/min record the steady vacuum (typically after a few seconds of pumping). The ratio of flow rate divided by vacuum should be approximately constant and should be higher than 0.01 L/min/in-H<sub>2</sub>O (i.e. >100 mL/min flow with <10 in-H<sub>2</sub>O vacuum), otherwise, it may be appropriate to install another sub-slab probe to verify whether this low-permeability condition is localized (possibly even a plugged probe) or laterally continuous.

The flow and vacuum readings will stabilize almost instantaneously; therefore, the total volume of soil gas removed during the flow and vacuum test will be minimal. This is desirable, because excessive purging could potentially cause indoor air to flow into the sub-slab void space through any nearby discontinuities that may exist in the floor slab. A total volume of no more than a few liters should be removed during this test.

If indoor air sampling is also planned for the same site visit, exhaust gas from the vacuum pump should be routed to an outside location by an adequate length of tubing or through a trap filled with activated carbon. This will ensure that the subsequent indoor air samples are not positively biased by any VOC vapors removed during the soil gas flow and vacuum test.

## **F.5 Purging and Sample Collection**

Purging and sampling can proceed any time after the probe seal has set and the flow and vacuum measurements have been confirmed. The objective of purging is to ensure the collection of a “fresh” sample of sub-slab gas, not gas that has been stagnant within the probe or possibly introduced during the drilling and installation process. Field screening should generally be used to confirm steady readings, and to verify that the sample is reproducible. Tracer gas should also be used to ensure that there are no leaks in the probe seals, in addition to confirming absence of leaks using the “shut-in” test.

The recommend tracer gas is helium because it is non-toxic, readily available, easily field-screened using a portable instrument, and not a chemical that is known to be present in the subsurface at concentrations that could interfere with the portable instrument readings. The total volume of tracer gas to be added to the air-space under the shroud does not have to be large to be effective. For example, a helium cylinder open for several seconds will generally be sufficient to



create concentrations in the shroud that are above 40% by volume. The air under the shroud should be screened with the portable monitoring device after adding the tracer, which can be done through a hole in the shroud. Other tracer gases that may be used include isobutylene, butane, or propane, providing the site does not have hydrocarbon vapors that could interfere with these compounds. The ionization potential of butane and propane are higher than most photoionization detector (PID) lamps, so a high-energy PID lamp or a flame ionization detector (FID) would be required. For unambiguous determination of butane or propane, a mobile gas chromatograph (GC) would be required.

Sampling for laboratory analysis will typically be performed using Summa canisters or Automatic Thermal Desorption (ATD) tubes. Summa canister samples can be collected by two methods: 1) connecting the Summa canister directly to the sub-slab probe after purging has demonstrated reproducible field screening readings, or 2) collecting a soil gas sample in a Tedlar bag, and then connecting the Tedlar bag to the Summa canister to transfer the sample to the Summa canister. The latter is recommended, because it allows the Tedlar bag to be screened for consistent FID or PID readings and presence of tracer gas before the Summa canister sample is collected, and if the tracer gas screening indicates a leak, the leak can be fixed and the purging and sampling repeated prior to sampling for laboratory analysis. The former method also requires a flow controller on the Summa canister, otherwise the strong vacuum of the Summa canister can draw moisture or particles into the canister. Flow controllers have a set flowrate that cannot be adjusted in the field, and may not be appropriate for certain gas permeability conditions, which are typically not known in advance. ATD tube sampling procedures depend on compounds of concern, relative and absolute concentrations, and the subsurface gas permeability, which may or may not be adequately known in advance of mobilization for field-work and; therefore, the methods require close communication between the field sampling team and the analytical chemist.

### ***F.5.1 Preparation***

Assemble the apparatus as shown in **Figure F-3**, and the photograph below:



### **Soil Gas Purging and Sampling Procedure**

1. Connect the discharge of the vacuum pump to tubing that runs to an outdoor location to prevent any extracted gas from causing potential positive bias in any subsequent indoor air samples. If this is not practicable, the pump discharge can be collected in a large plastic garbage bag, secured to the pump discharge pipe with a hose-clamp during purging and sampling, and carried outside prior to emptying.
2. Calibrate field instruments, or perform a calibration check by measuring zero gas and span gas samples, each stored in dedicated Tedlar bags. Field screening should be done using an FID or PID at a minimum, but may also include O<sub>2</sub>/CO<sub>2</sub> readings, an explosimeter, etc., depending on the site-specific chemicals of concern. A helium meter is also recommended for tracer gas screening.
3. Perform an equipment blank screening to ensure the absence of detectable PID or FID readings. Attach the Tedlar bag to the tubing inside the lung-box and open the Tedlar bag's valve and connect to an appropriate length (1 to 2 ft.) of ¼-inch HDPE, Teflon™ or Nylon tubing (sufficient to connect the lung box to the sub-slab probe without kinks). Secure the lid of the lung box and evacuate the lung box using the vacuum pump to fill the Tedlar bag with ambient air. When the Tedlar bag is almost full, turn off vacuum pump, remove the Tedlar bag from the lung-box and screen the Tedlar bag for VOCs with the PID. If the Tedlar bag contains detectable VOCs, empty the bag and repeat this step until there are no measurable readings or replace the Tedlar bag and tubing with new materials and repeat.
4. In advance of purging, prepare the Summa canister. One-litre Summa canisters are preferred, because this volume is sufficient for the detection limits required to meet screening levels, and they are easier to handle and are less subject to risks of over-purging than 6-litre Summa canisters. Record the registration number on the sample log form. Remove the cap from the Summa canister, making sure that the valve is still closed. Attach the vacuum gauge via Swagelock™ fitting and turn ¼ turn past snug. Open the valve and record the initial vacuum, which should be close to 30 inches of mercury (otherwise, the Summa canister may

have leaked during shipping and should not be used). Close the valve, remove the vacuum gauge and connect the 5-micron stainless steel filter via Swagelock™ fitting and turn ¼-turn past snug.

- a. If the Summa canister sample will be collected by sub-sampling from a Tedlar bag sample, use a compression fitting to attach a short (<2-inch) length of new, ¼-inch HDPE, Teflon™ or Nylon tubing to the 5-micron filter via Swagelock™ fitting, turned ¼ turn past snug, in preparation for attachment to the Tedlar bag.
- b. If the Summa canister sample will be collected by direct connection to the sub-slab probe, connect a laboratory-certified flow controller to the 5 micron filter via Swagelock™ fitting, and turn ¼ turn past snug.

### **F.5.2 Purging and Field Screening**

1. Connect a short (~1 ft) length of new, ¼-inch HDPE or Nylon tubing to the ball valve on the top of the probe using compression or barbed fitting. Slide the tubing through a 1/4-inch hole drilled through the side-wall of a large (3 to 10 L) clear plastic container, which will act as a shroud for the tracer gas. Attach a stainless steel valve to the end of this tubing using compression or barbed fittings. Connect another short (~1 ft) length of new, ¼-inch HDPE, Teflon™ or Nylon tubing to the other side of this ball valve, and slide it through the wall of the lung box using a compression fitting, as shown in **Figure F-3**. Attach a 1L Tedlar bag to the end of this tubing with a compression or barbed fitting, open the valve on the Tedlar bag, and secure the bag within the lung box.
2. Open the valve at the top of the sub-slab probe, and position the shroud centrally over the probe and valve, adjusting the tubing to minimize any tension.
3. Connect the evacuation port on the lung box to the vacuum pump. The tubing for this can be re-used, because the sample never comes into contact with the gas that will be sampled.
4. Inject helium into the shroud through the injection port on one side of the shroud, and monitor the concentration of helium inside the shroud by inserting the intake of the helium meter into the sampling port on the other side of the shroud. Continue adding helium until the concentration within the shroud is in the range of 10 to 50% by volume.
5. Check that the valve at the inlet of the vacuum pump is closed, then turn on the pump and open the valve at the head of the pump slowly, until the rotameter reading is in the range of 200 to 500 mL/min, preferably with a vacuum of <1 inH<sub>2</sub>O. The flow and vacuum test procedure (described above) should be used to select the best compromise between flow-rate and vacuum, if the gas permeability is low.
6. When the Tedlar bag is nearly full, close the valve outside the shroud in the line between the probe and the Tedlar bag, then turn off the pump, vent the lung box (crack the seal to relieve the vacuum), and disconnect the tubing from the compression or barbed fitting at the downstream end of the valve outside the shroud. Connect the tubing from the Tedlar bag to the calibrated field instruments (helium meter, PID or FID, O<sub>2</sub>/CO<sub>2</sub>, explosimeter, etc.) in sequence and record the time and stable readings on the sampling form (attached).

7. It is important that the Tedlar bag contents be at ambient pressure for both calibration and screening readings. If the bag is pressurized, the flow rate through the portable instrument may increase and result in variable readings.
8. If the concentration of helium in the Tedlar bag sample from the sub-slab probe is greater than 5% of the concentration in the shroud in two successive Tedlar bag samples, the probe seal and valve should be reviewed to determine whether there is a leak. If there appears to be a leak through the probe seal, it may be possible to minimize the leak by adding water to the seal between the probe and the floor slab or a paste of bentonite and water around the top of the probe. Otherwise the probe may need to be replaced.
9. Repeat the purging and field screening procedure for a minimum of 3 readings. PID/FID readings should be stable, indicating a reproducible sample. If PID/FID readings are decreasing, it may indicate the influx of indoor air (even in the absence of significant levels of tracer gas in the sample, possibly due to a crack in the floor just outside the shroud). An atmospheric air leak may also be indicated by increasing O<sub>2</sub> and decreasing CO<sub>2</sub> concentrations at sites with aerobically degradable compounds. If atmospheric air leaks are suspected by these trends in the field screening data, the probe should be allowed to re-equilibrate for at least an hour, and subsequent sampling should be completed after purging of a single Tedlar bag sample. If there are no detectable PID or FID readings it is not possible to confirm steady readings, but the absence of significant concentrations of tracer gas will verify that the samples are representative of the sub-slab zone.

### **F.5.3 Summa Canister Sample Collection**

1. If field screening readings are stable after 3 Tedlar bag samples, samples should be collected for laboratory analysis. Collect the Summa canister sample first, via one of the following two options:
  - a. Preferred Option: collect one additional Tedlar bag sample, screen it with the helium meter to confirm absence of leaks, and then connect the Tedlar bag directly to the Summa canister using compression fittings. Open the Summa canister valve slowly and close it again before the bag is completely drained.
  - b. Alternate Option: Lift the shroud, close the valve at the top of the sub-slab probe, remove the tubing and connect the flow controller of the Summa canister to the probe valve directly with compression or barb fittings to as short as possible piece of ¼-inch HDPE, Teflon™ or Nylon tubing to minimize the dead volume. Open the valve on the probe, then open the valve on the canister. A 1-L Summa canister should fill within 5 minutes if the flow controller was set to 200 ml/min (recommended), unless the gas permeability of the subsurface materials is low, in which case, additional time should be allowed, using judgment and review of the flow and vacuum testing data. Alternatively, some Summa canisters have flow controllers with vacuum gauges in-line, in which case, the sampling should be stopped when there is still at least 1 inch of mercury vacuum. After allowing sufficient time for the sample to be collected, close the valve on the Summa canister, then close the valve on the probe.
2. Remove the 5-micron filter (and flow controller, if used) from the Summa canister, and replace it with the vacuum gauge (¼ turn past snug). Re-open the valve on the Summa

canister and record the final vacuum (should be less than a few inches of mercury, but may also be zero). If the residual vacuum is more than a few inches of mercury, the laboratory reporting limits may be increased, so the potential implications with respect to data quality objectives will need to be considered. Close the Summa valve, remove the vacuum gauge, and replace the cap on the Summa canister valve in preparation for return shipping. Double check that the cap and valve on the Summa are tightly closed. Record the final vacuum on the sampling form and the chain of custody.

3. The label tag on the Summa canister should be filled-out with the site name, sample ID#, sampler's name, project code, and date and time of sample.
4. Remove the valve from the sub-slab probe replace it with the cap, freshly wrapped with new Teflon tape.

This procedure should be repeated for each sub-slab soil gas probe.

#### **F.5.4 ATD Tube Sample Collection**

ATD tube sampling requires an estimate of subsurface compounds and concentrations to select the appropriate adsorbent materials, flow rate and sample volume to avoid elevated detection limits or breakthrough. Assuming this information is generally limited or not available in advance, the sample flow rate and volume may need to be adjusted in the field, depending on the results of the FID or PID screening. This requires input from an experienced analytical chemist. Considerations for possible ranges of site conditions should be discussed and agreed in advance, preferably being incorporated into the sampling and analysis plan. ATD tubes are usually used in combination with personal sampling pumps with variable flow rates (**see Attachment 1**), so both the flow rate and sample duration can be adjusted to minimize the risk of breakthrough, depending on the chemicals expected to be present and their relative and absolute concentrations. It is recommended to use two ATD tubes in series, and after analysis of the leading tube, assess whether the mass present was sufficiently high to indicate a risk of breakthrough, in which case, the trailing tube can also be analyzed and the mass added to make a better approximation of the sub-slab vapor concentration.

#### **F.6. Chain of Custody and Sample Handling**

The label tag on the mini-Summa canister should be filled-out with the site name, sample ID #, sampler's name, project code, date and time of sample, initial and final vacuum levels, and analysis requested. A chain of custody (COC) form should be completed with each sample shipment. The COC should include the sample ID, ATD tube or canister number, analysis requested, flow rate and sample duration for ATD tubes, and any special instructions. The laboratory will confirm the final vacuum level for each Summa canister upon receipt to verify that the Summa canister valve and cap did not leak during shipment. Canisters and ATD tubes do not need to be refrigerated, but should be shipped with sufficient padding to prevent damage if the container is accidentally dropped.

The COC form should be signed by the sampler and placed in the shipping container, then the shipping container should be wrapped securely using packing tape. The sampler should sign the packing tape across the seam of the lid of the container, so it cannot be opened without damaging the signature. Upon arrival, the laboratory will confirm the signature to be intact, and complete the COC form. Analyses should be scheduled with the analytical laboratory to be completed within acceptable holding times. Summa canisters should be analyzed within 2 weeks. ATD tubes with compression-fit caps are stable for a very long time, but analysis should nevertheless be completed within less than 2 weeks.

## **F.7 Field QC Samples for Soil Gas Sample Collection**

Field quality control (QC) samples should be collected to monitor sampling and analytical performance. A complete record of all QC samples collected must be maintained as a part of the sampling documentation. The definition and purpose of each type of QC sample, and the procedures for their collection and handling are described in the paragraphs below.

Ambient Air Screening: Before field screening at each soil gas probe, an ambient air sample will be screened by drawing ambient air into a PID or FID over a period of at least one minute and recording the range of readings occurring during that time period. This ambient air screening should provide no detectable concentrations, but any readings observed may be useful to identify background conditions and evaluate potential biases.

Equipment Blanks: Prior to purging, an equipment blank should be performed to ensure the absence of measurable VOC vapors. Disconnect the tubing from the valve on top of the soil gas probe, and fill the Tedlar Bag with zero gas (preferred) or outdoor air through the tubing. Equipment blank readings should be made using a PID or FID, calibrated to span gas and zero gas according to manufacturers instructions. Atmospheric air may be used as zero gas in areas of generally good air quality, but should be avoided in high traffic areas, smog areas, or areas with any noticeable odors. If the equipment blank reading is above the FID or PID detection limit, repeat the equipment blank step with a new Tedlar bag and new length of tubing. If this does not result in a blank with no detectable VOCs, the FID or PID calibration should be repeated and the equipment blank process repeated. If this still does not provide an equipment blanks below the FID or PID detection limit, a project management decision will be required regarding whether to proceed with sampling, or whether to replace or perform service on the FID or PID.

Field Duplicate Sample: During the soil gas probe sampling, a field duplicate sample will be collected using regular sampling procedures immediately after collecting the investigative sample. The field duplicate sample will be analyzed to identify sample variability. The duplicate sample will be submitted for analyses without indication of which sample the duplicate represents (i.e., blindly). If the monitoring program includes multiple samples (i.e. Summa canister for VOCs, ATD tube for SVOCs, possibly Radon, etc.), the duplicate should also include the entire suite. Field duplicate samples are recommended at a frequency of one for every 10 investigative samples.

Trip Blanks: Trip blanks are Summa canisters or ATD tubes that are shipped with other samples from the laboratory to the field site and back without a sample being collected. Their analysis

should not detect any chemicals, but if there are potential contaminants encountered during the trip, the trip blank will identify them.

**Blanks and Blind Blanks:** A laboratory can analyze a Summa canister filled with ultra-high purity nitrogen (UHPN), to test for potential fugitive contaminants in the laboratory, or carry-over in the canister from previous samples; however, the Summa canisters have engraved serial numbers, so this is not a “blind” blank. For a blind blank, the laboratory can provide a Summa canister filled with UHPN, which can then be connected to another Summa canister with swagelock fittings to enable the blank sample to be truly anonymous (i.e. “blind”).

## **F.8 Equipment Cleaning**

New or dedicated materials are preferred to minimize the risk of cross-contamination or carry-over from one sample to the next. The Tedlar bag may be re-used for field screening, but should be flushed using atmospheric air and completely drained three times between uses and verified clean by the equipment blank procedure. New or dedicated Tedlar bags are necessary if a Summa canister sample is to be drawn from a Tedlar bag after field screening. Brass and stainless steel valves should be heated and flushed with ample amounts of air to strip any residual VOCs between sampling events.

## **F.9 Documentation**

Field documentation will include instrument calibration information; date, time and location of readings; purging rate and vacuum induced; number of Summa canisters filled; sampler’s name; and a detailed description of the equipment set up for each location. The series of field screening readings will be recorded on the sampling log sheets. A list of the soil gas probes sampled and the sampling order for all samples and QA/QC samples will be recorded on the sampling field records. Photographs are recommended to aid in recording equipment set-up.

For each sampling day, the following information will be recorded on the daily field logs

- name and number of project;
- name of field personnel;
- date and time of sampling event;
- list of the primary activities performed;
- identification of probes screened;
- time when soil gas samples were collected; and,
- all related information (weather, attendees, equipment problems, any departures from standard procedures and the reasons and responses) observed throughout the day.
- Field instrument information and calibration data;
- Value of probe dead space volume for each soil gas probe;

- Time, probe soil gas readings (and tubing blank reading) for each probe volume (or Tedlar™ bag filled); and
- Time and reading for each instrument calibration check.

## **F.10 References and Suggested Reading**

American Petroleum Institute (API), 2004. Collecting and Interpreting Soil Gas Samples from the Vadose Zone: A Practical Strategy for Assessing the Subsurface-Vapor-to-Indoor-Air Migration Pathway at Petroleum Hydrocarbon Sites, Final Draft, October 2004.

American Society for Testing and Materials (ASTM), 1992, Standard guide for soil gas monitoring in the vadose zone, ASTM D 5314-92, *American Society for Testing and Materials*, West Conshohocken, Pennsylvania, Annual Book of ASTM Standards, v. 04:09.

Auer, L.H., N.D. Rosenberg, K.H. Birdsell, and E.M. Whitney. 1996. *The Effects of Barometric Pumping on Contaminant Transport*. Journal of Contaminant Hydrology, 24:145-166.

British Petroleum (BP). 1998. SPP-110 Vadose Zone Sampling at BP Corrective Action Sites. Global Environmental Management, a BP Affiliated Company. Lisle IL.

Carrigan, C.R., S.A. Martins, A.L. Ramirez, W.D. Daily, G.B. Hudson, J.J. Nitao, B. Ekwurzel, and D. Ralston. 2000. *Characterization of Contaminant Transport by Gravity, Capillarity and Barometric Pumping in Heterogeneous Vadose Zones*. UCRL-ID-142784, Lawrence Livermore National Laboratory.

Neeper, D.A. 2001. A model of oscillatory transport in granular soils, with application to barometric pumping and earth tides. J. Contam. Hydrol. 48:237–252.

Parker, J.C., 2003. Physical Processes Affecting the Natural Depletion of Volatile Organic Compounds in Soil and Groundwater, Vadose Zone Journal, 2:222-230 (2003)

Posner, J.C., and W. J. Woodfin. 1986. Sampling with gas Bags I: Losses of Analyte with Time. Appl. Ind. Hyg., 1(4):163-168.

Puls, R.W., and Barcelona M.J., 1996. EPA Ground Water Issue Low-Flow (Minimal Drawdown) Ground-Water Sampling Procedures, EPA/540/S-95/504.

United States Environmental Protection Agency (US EPA), 2004. Standard Operating Procedure (SOP) for Installation of Sub-Slab Vapor Probes and Sampling Using EPA Method TO-15 to Support Vapor Intrusion Investigations, ORD, Ada, OK, DRAFT – February 12, 2004.

United States Environmental Protection Agency (US EPA), 1999c. *Compendium of Methods for the Determination of Toxic Organic Compounds in Ambient Air – Second Edition*. (EPA/625/R-96/010b) Center for Environmental Research Information.



- United States Environmental Protection Agency (US EPA), 1997e, Expedited site assessment tools for underground storage tank sites: A guide for regulators, EPA 510/B/97/001, March 1997, Washington, D.C.
- United States Environmental Protection Agency (US EPA), 1996d. Soil Gas Sampling. Standard Operating Procedure No. 2042. Environmental Response Team. Washington, D.C., June 1, 1996.
- United States Environmental Protection Agency (US EPA), 1995b, SUMMA canister sampling, U.S. Environmental Protection Agency Environmental Response Team, Standard Operating Procedure 1704, July 27, 1995, Washington, D.C., 8 p.
- United States Environmental Protection Agency (US EPA), 1994a, Tedlar bag sampling, U.S. Environmental Protection Agency Environmental Response Team, Standard Operating Procedure 2102, October 10, 1994, Washington, D.C., 5 p.
- United States Environmental Protection Agency (US EPA), 1994d, Guidance for the Data Quality Objectives Process (EPA QA/G-4). Office of Research and Development, Document No. EPA/600/R-96/055. September 1994.
- United States Environmental Protection Agency (US EPA), 1992a. Air/Superfund National Technical Guidance Study Series: Assessing Potential Indoor Air Impacts at Superfund Sites. Office of Air Quality Planning and Standards. Research Triangle Park. North Carolina. Report EPA/451/R-92/002.
- United States Environmental Protection Agency (US EPA), 1992c. *Guidance for Data Usability in Risk Assessment (Part A) Final*. (Publication 9285.7-09A PB92-963356) Office of Emergency and Remedial Response.
- United States Environmental Protection Agency (US EPA), 1988a. EPA Guidance for Quality Assurance Project Plans. (EPA/600/R-E8/018).
- Weeks, E.P. 1979. *Barometric Fluctuations in Wells Tapping Deep Unconfined Aquifers*. Water Resources Research, 15:1167-1176.

## **F.11 Attachment 1: Recommended Equipment**

Mention of specific brand names and models does not constitute product endorsement. The suggested equipment can be substituted with equivalent equipment, but it is the responsibility of the user to ensure that substitute equipment meets the requirements.

**Tubing:** High Density Polyethylene (HDPE) tubing is generally acceptable for low sorption (Barcelona et. al., 1983), and works well with compression fittings or barbed fittings. Nylon tubing is considered equally appropriate. Teflon™ tubing is considerably less flexible than HDPE and may not work as well with barbed fittings. Tubing may also be stainless steel or copper, which forms air-tight seals when used with Swagelock™ fittings, but is more expensive and less flexible than HDPE. Soft flexible tubing should be avoided (except for the discharge line from the pump discharge to an outdoor location, if used), because vapors tend to adsorb more strongly to them.

**Rotameter-Style Flowmeters:** Dwyer Model RMB-5-49 with a range up to 5 standard cubic feet per hour (SCFH) (2.4 L/min), and Model RMB-5-52 with a range up to 50 SCFH (24 L/min).

**Vacuum Gauges:** Dwyer Magnehelic™ gauges, which are available in several ranges, including zero to 0.25 in-H<sub>2</sub>O, zero to 5 in-H<sub>2</sub>O, and zero to 100 in-H<sub>2</sub>O.

**Vacuum Pump:** GAST, DOA-P101-AA piston pump

**Lung Box:** Xitech Instruments, Inc. Model 1060 1 L Bag Sampler

**Helium Meter:** Mark 9822 helium detector

**Portable FID/PID:** Foxboro TVA 1000 FID/PID, miniRAE 2000, ppbRAE, Photovac Microtip.

**Personal Sampling Pump:** Sensidyne Gilian GilAir-3 Constant Flow Sampling Pump

**ATD Tubes:** supplied by laboratory, after discussion of target chemicals, relative concentrations, target detection limits, and potential ranges of concentrations.

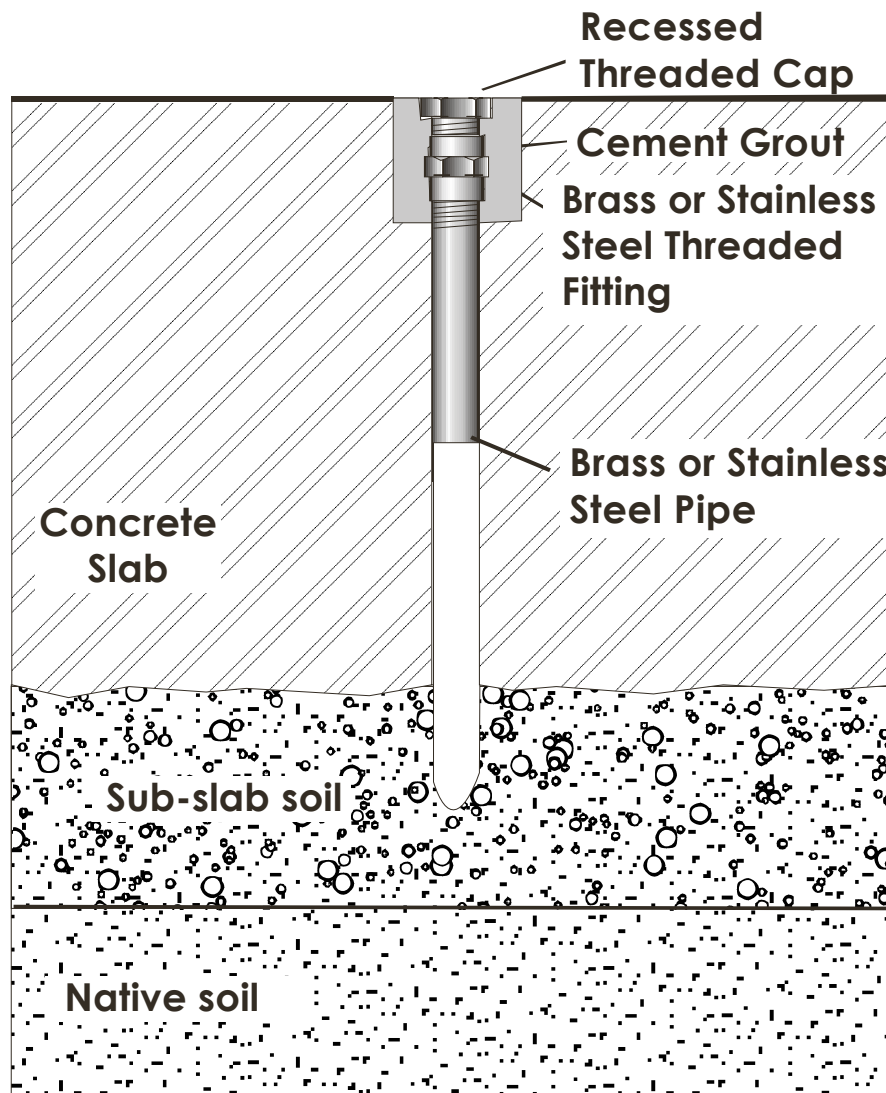

<b>Sub-Slab Probe</b> GeoSyntec Consultants, Suggested Operating Procedure		
Jan 2005	Figure:F-1	 <b>GEOSYNTEC CONSULTANTS</b>

modified from EPA, 2004

SLP-1520-01

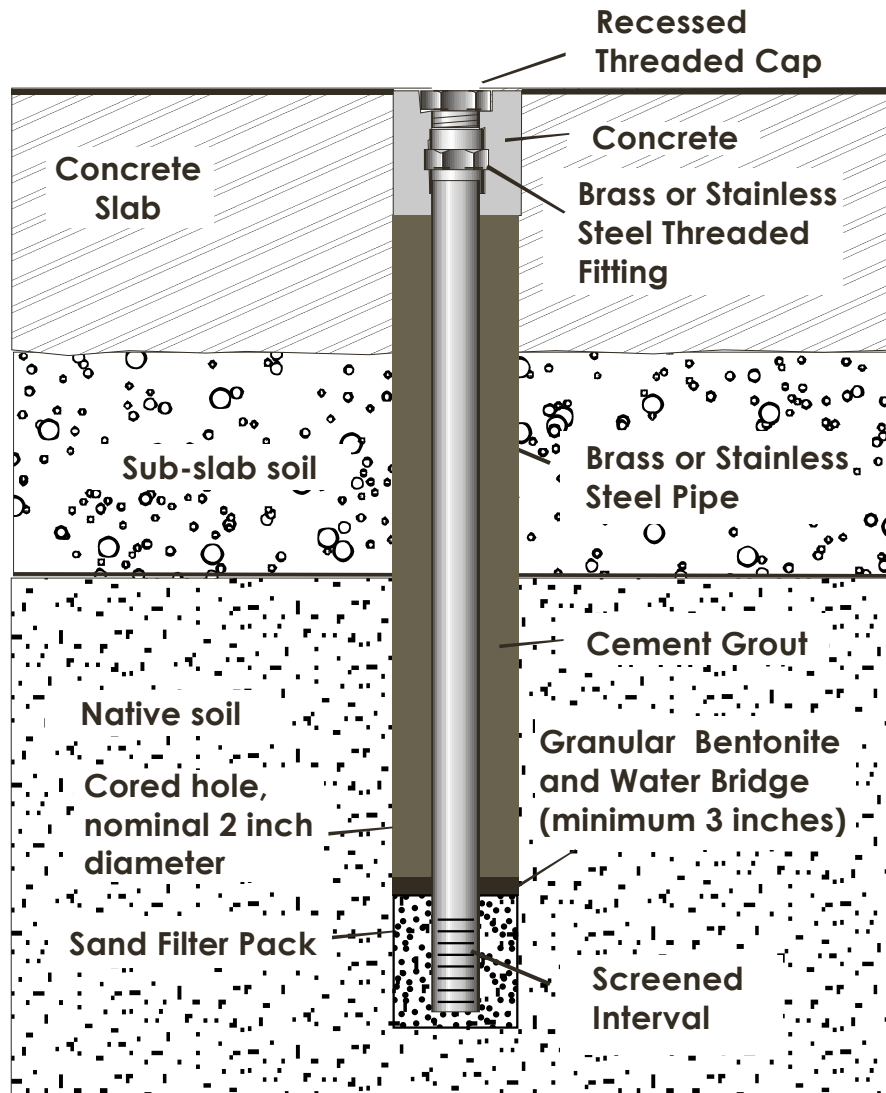

<b>Sub-Slab Vapor Probe (Type 2)</b> GeoSyntec Consultants, Suggested Operating Procedure	
Jan. 2005	Figure:F-2
	

modified from EPA, 2004

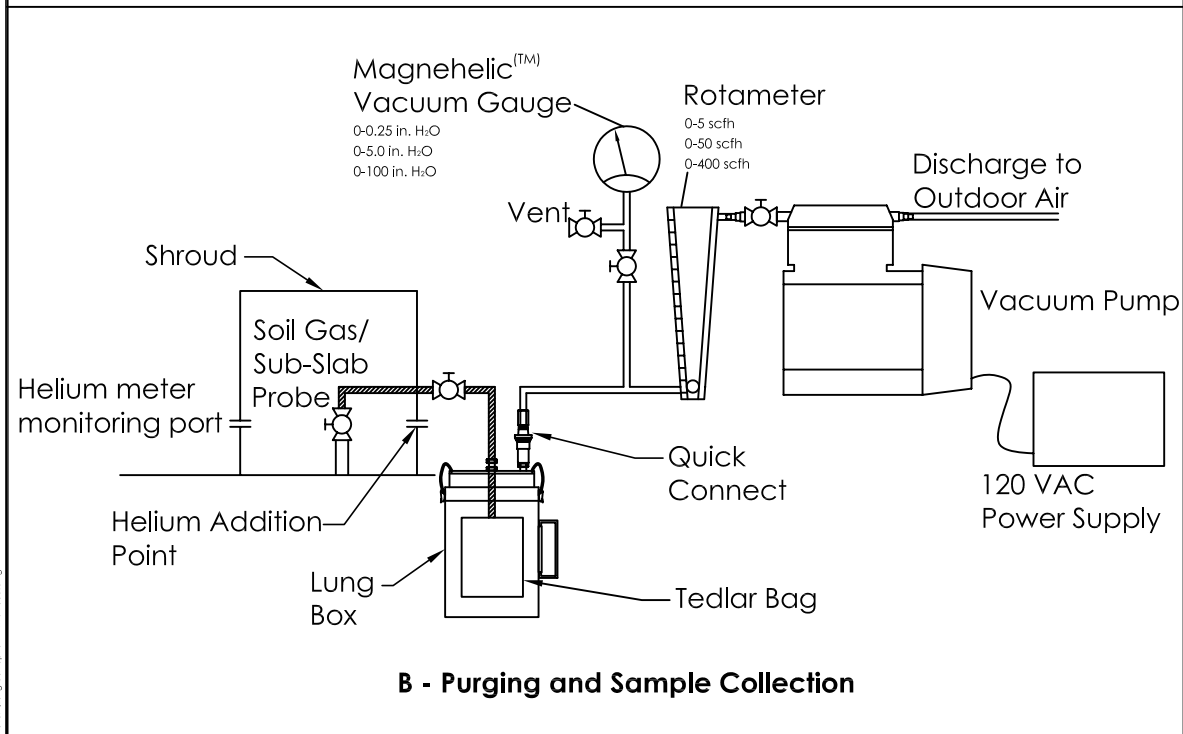
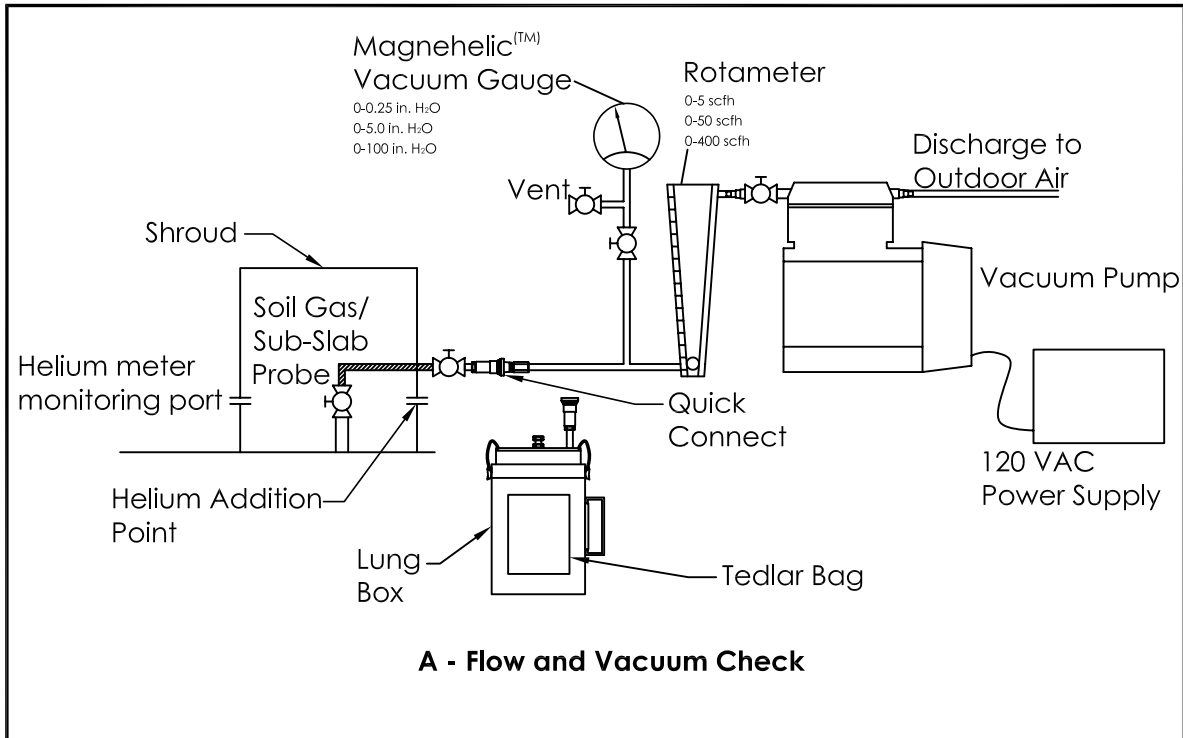

High Density Polyethylene Tubing (HDPE), Nylaflo, Teflon, Stainless Steel  
 Low Density Polyethylene Tubing (LDPE)

**Soil Gas Sampling Apparatus**

Jan. 2005

Figure: F-3



F:\Graphics\GeoSyntec\PROJECTS\1001\SP\lung\_box\_option\_with\_shroud.dwg

**GEOSYNTEC CONSULTANTS**   
 130 Research Lane, Suite 2  
 Guelph, Ontario, Canada N1G 5G3  
 (519)822-2230 Fax (519)822-3151

**PNEUMATIC TESTING RECORD**

<b>Project Name:</b> _____	<b>Well No.:</b> _____ <input type="checkbox"/> Pumping Well <input type="checkbox"/> Observation Well
<b>Project Number:</b> _____	<b>Well Depth (m btoc):</b> _____
<b>Location:</b> _____	<b>Well Volume (L):</b> _____
<b>Field Personnel:</b> _____ _____	<b>Temperature (°C):</b> <input type="checkbox"/> _____ <b>Wind Speed (mps):</b> _____
<b>Recorded By:</b> _____	<b>Atmospheric Pressure (mbar):</b> _____
	<b>Date:</b> _____

Time	Initial Pressure / Vacuum in Vapour Monitoring Well Prior to Pumping: (inches H <sub>2</sub> O)	<input type="checkbox"/> Vacuum <input type="checkbox"/> Pressure
------	--	--

Time	Elapsed Time (min.)	Pump Flow Rate (scfm)	Well Head Vacuum (inches H <sub>2</sub> O)	Cumulative Volume (scf)	CO <sub>2</sub> (%)	O <sub>2</sub> (%)	VOCs by PID (ppmv)

**Comments:**

---



---



---



---

**SOIL GAS SAMPLING FIELD FORM**

Site: _____	Probe ID: _____
Field Personnel: _____	Location: _____
Recorded by: _____	Weather: _____
Probe purge volume: _____	Date: _____

Initial Pressure/Vacuum in Probe/well:			Pneumatic Test:			Ambient Air Screening Results:		
Time	Positive Pressure (in-H <sub>2</sub> O)	Negative Pressure (inches H <sub>2</sub> O)	Time	Flow Rate (L/min)	Probe vacuum (in-H <sub>2</sub> O)	Time	Initial	Final
							CO <sub>2</sub> , CH <sub>4</sub> , H <sub>2</sub> S :	CO <sub>2</sub> , CH <sub>4</sub> , H <sub>2</sub> S :
							O <sub>2</sub> :	O <sub>2</sub> :
							PID:	PID:

Probe/Well Purge Data:										
Time	Elapsed Time (min)	Pump Flow Rate (L/min)	Well Head Vacuum (in-H <sub>2</sub> O)	CO <sub>2</sub>	O <sub>2</sub>	CH <sub>4</sub>	H <sub>2</sub> S	PID (ppm)	FID (ppm)	Atmospheric Pressure (mbar)

Samples sent for Laboratory Analysis:				
Sample Type	Summa Canister Number	Sample ID	Analytical Method Requested	Turn Around Time

Notes:	Comments (e.g., sampling difficulties, deviations from protocol):
ppm - parts per million      H <sub>2</sub> S - hydrogen sulfide      FID - flame ionization detector	
in-H <sub>2</sub> O - inches of water column      CO <sub>2</sub> - carbon dioxide      PID - photoionization detector	
L/min - liters per minute      O <sub>2</sub> - oxygen	
CH <sub>4</sub> - methane	





# **G**

## **GUIDE TO AIR SAMPLING AND ANALYSIS: CANISTERS AND TEDLAR™ BAGS**

---

(Courtesy of Air Toxics Limited)

**Reference to any trade names or trademarks should not be construed as an endorsement by EPRI, its Cosponsors or agents or the authors.**

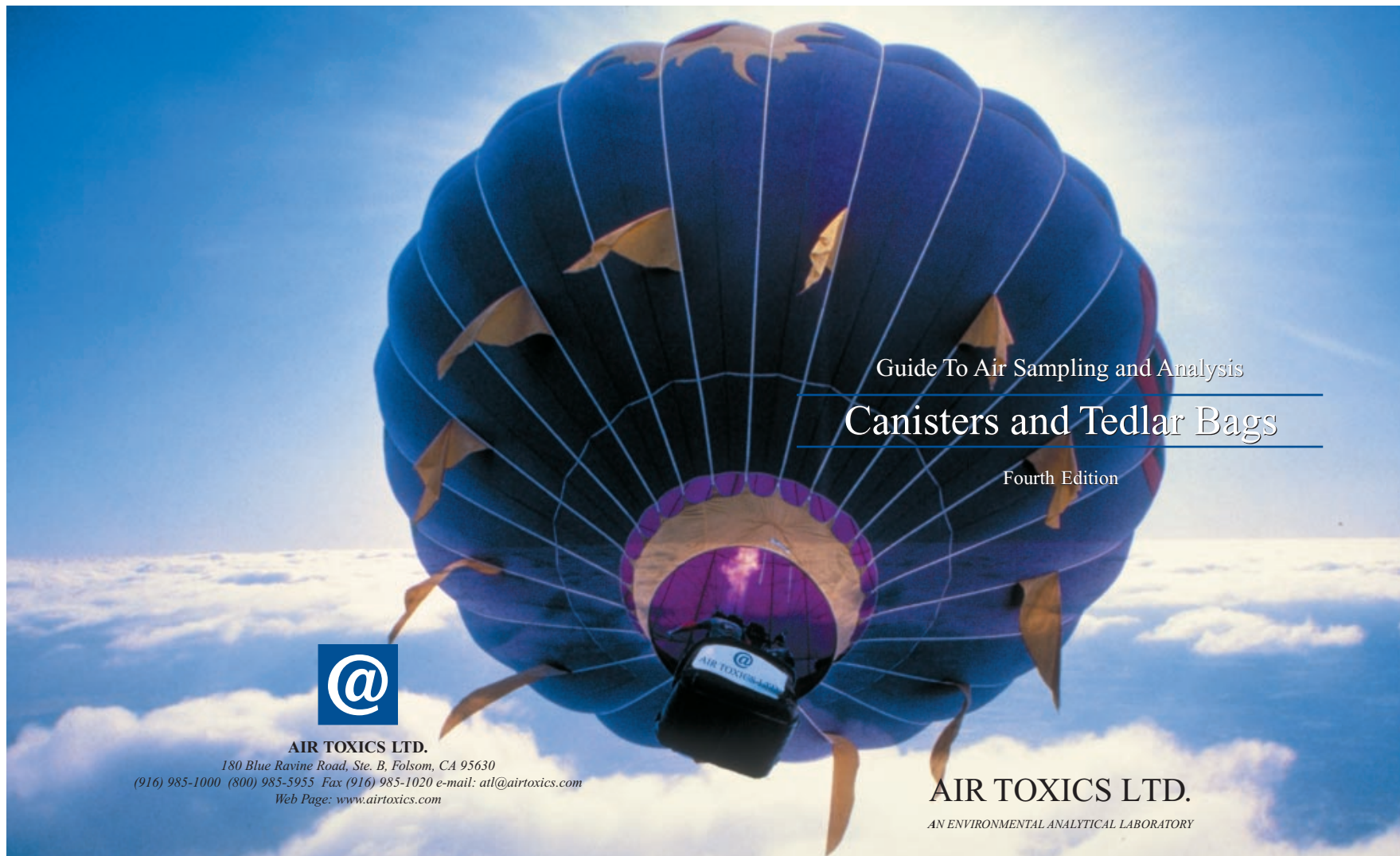

Guide To Air Sampling and Analysis  
**Canisters and Tedlar Bags**  
Fourth Edition



**AIR TOXICS LTD.**  
180 Blue Ravine Road, Ste. B, Folsom, CA 95630  
(916) 985-1000 (800) 985-5955 Fax (916) 985-1020 e-mail: [atl@airtoxics.com](mailto:atl@airtoxics.com)  
Web Page: [www.airtoxics.com](http://www.airtoxics.com)

**AIR TOXICS LTD.**  
AN ENVIRONMENTAL ANALYTICAL LABORATORY



### Table of Contents

<b>1.0 Introduction</b>	<b>3.0 Tedlar Bag Sampling</b>
1.1 Whole Air Sampling of VOCs	3.1 Introduction to Tedlar Bags
1.2 Choosing Between Canisters and Tedlar Bags	3.2 Tedlar Bag Sampling
1.3 Organization of this Guide	<b>4.0 Special Sampling Considerations</b>
<b>2.0 Canister Sampling</b>	4.1 Special Sampling Configurations
2.1 Introduction to Canisters	4.2 Considerations for Sampling at Altitude
2.2 Associated Canister Hardware	4.3 Considerations for Soil/Landfill Gas Sampling
2.3 Grab Sampling with Canisters	4.4 Considerations for Sample Cylinder Sampling
2.4 Integrated Sampling with Canisters and Flow Controllers	

### Tables

1.2 Comparison of Canisters to Tedlar Bags	2.4.4 Relationship Between Final Canister Vacuum, Volume Sampled, and Dilution Factor
2.2.3 Fill Times for Canisters	2.4.5 Gauge Readings for an 8-Hour Sampling Interval
2.4.3 Flow Rates for Selected Sampling Intervals	

## Section 1.0 Introduction

Air Toxics Ltd. presents this guide as a resource for individuals engaged in air sampling. Air sampling can be more involved than water or soil sampling due to the reactivity of chemical compounds in the gas matrix and sample interaction with the sampling equipment and media. Ensuring that air samples are collected properly is an important step in acquiring meaningful analytical results. This guide is not a substitute for experience and cannot possibly address the multitude of actual field conditions. Note that this guide is intended for typical projects involving whole air sampling of volatile organic compounds (VOCs) in canisters and Tedlar bags. Air Toxics Ltd. provides the “Guide to Air Sampling and Analysis - Sorbents, Solutions, and Filters” for other types of sampling.

### 1.1 Whole Air Sampling of VOCs

There are four general ways to collect compounds in a gas phase sample. A sampler can collect the gas in a container or draw the gas through a sorbent, solution, or filter. This guide focuses on collecting a sample in the most common air sampling containers, Summa canisters and Tedlar bags. The sample can be collected in the container either passively (i.e., by evacuating the canister prior to sampling) or actively (i.e., using a pump). The container is subsequently sealed and transported to the laboratory for analysis. The sample is referred to as a “whole air sample” and the compounds remain in the gas matrix (e.g., ambient air) inside the container.

As a general rule, whole air sampling is best when target compounds are volatile, non-polar, and have boiling points less than 170 C, although exceptions to this rule can be found. Recovery of any given compound in a whole air sample is very much dependent upon the humidity of the sample, the chemical activity of the sample matrix, and the degree of inertness of the container.

### 1.2 Choosing Between Canisters and Tedlar Bags

Deciding whether a canister or a Tedlar bag should be used for collecting a whole air sample depends on the type of air sampling application. The Tedlar bag is best used as a “ppmv” (parts per million by volume) whole air sample container. In other words, it is best suited for air sampling applications involving compound concentrations well above the low ppbv (parts per billion by volume) range. Soil/landfill gas surveys, monitoring soil vapor extraction (SVE) systems, and sampling for atmospheric/fixed gases are applications well suited for Tedlar bag sampling. Ambient and indoor air projects driven by risk assessment or litigation are better suited for Summa canisters that are cleaned and individually certified free of the target compounds. The different degree of compound inertness between the two sample container surfaces is reflected in their suggested hold times for VOCs - 3 days from sampling to analysis for a Tedlar bag compared to 14-30 days for a Summa canister. Analyses of new Tedlar bags reveal that some VOCs may be present at concentrations in the single digit ppbv range (see Section 3).

Table 1.2. Comparison of Canisters to Tedlar Bags

	Canisters	Tedlar Bags
Common Volumes	1 and 6 L	1, 3, and 5 L
Type of Sampling	Passive (vacuum)	Active (pump required)
Sample Handling	Room temperature	Room temperature
Media Hold Time	Up to 30 days recommended	Indefinite
Hold Time to Analysis	14-30 days	3 days
Surface Inertness	Excellent	Fair
Cleanliness	10% or 100% certified to ppbv/pptv levels	Some VOCs present at 0.5 to 45 ppbv
Sampling Application	Ambient/indoor air, soil/landfill gas, stationary source	Ambient air (fixed gases only), soil/landfill gas, stationary source
Rule of Thumb	“ppbv device”	“ppmv device”
Advantages	Inertness, hold time, ruggedness, no pump	Purchase/shipping cost, availability, convenience

The table above compares the features of canisters and Tedlar bags. Canisters have superior inertness, hold time to analysis, ruggedness, and do not require a sampling pump. Tedlar bags can be purchased inexpensively in bulk, carried to a sampling site in a briefcase, filled in seconds, and shipped easily to the laboratory for analysis. Call Client Services at 800-985-5955 if you have questions regarding sampling media.

### 1.3 Organization of this Guide

The remainder of this guide is divided into three sections: canister sampling, Tedlar bag sampling, and special sampling considerations. Section 2 on canister sampling and Section 3 on Tedlar bag sampling provide complete sampling media descriptions, practical considerations for sampling, and step-by-step sampling procedures. Photographs illustrate the correct way to assemble the various sampling components. Tables provide detailed information on many operational factors that ultimately influence the quality of the data obtained from a canister or Tedlar bag sample. Section 4 provides considerations for special sampling configurations such as field duplicates and ambient blanks. This section also provides considerations for sampling at altitude, soil/landfill gas sampling, and sample cylinder (or “sample bomb”) sampling.

If you have any questions after reading this guide, please call Client Services at 800-985-5955 before proceeding with sampling. Air Toxics Ltd. also provides technical articles on specific air topics in *Air Topics* publications and *In the Air* quarterly newsletters available upon request or on the Internet at [www.airtoxics.com](http://www.airtoxics.com).

## Section 2. Canister Sampling

This section provides a description of air sampling canisters, practical considerations for sampling, and step-by-step instructions for collecting a grab and integrated sample. Photographs illustrate the correct way to assemble the various sampling components. Tables provide detailed information on many operational factors that ultimately influence the quality of the data obtained from a canister sample.

### 2.1 Introduction to Canisters

An air sampling canister is a container for collecting a whole air sample for ambient and indoor air applications. The canister is best suited for projects involving analysis of compounds in the ppbv range. However, canisters can be used for other applications such as landfill and soil gas involving analysis of compounds in the ppmv range.

A canister can be spherical or cylindrical and is constructed of stainless steel. The canister is prepared for sampling by evacuating the contents to a vacuum of approximately 29.9 inches of Mercury (in. Hg). Opening the stainless steel bellows valve allows the air sample to enter the canister. When the target volume of sample is collected, the valve is closed and the canister is returned to the laboratory.

Canisters can range in volume from less than 1 liter (L) to greater than 6 L. At Air Toxics Ltd., 6 L canisters are used for ambient air samples and for taking integrated samples. 1 L canisters are normally used for taking high concentration (i.e., greater than 5 ppbv) grab samples, although exceptions to these guidelines are common. Variations of air sampling canisters include glass bulbs, sample cylinders (or “sample bombs”), and Summa canisters. Glass bulbs are rarely used in field applications due to lack of ruggedness. Sample cylinders are DOT-approved, high pressure, thick-walled, stainless steel cylinders with a valve at each end (see Section 4.4). The remainder of this section focuses on Summa canisters.



#### 2.1.1 Summa Canister

A Summa canister is a stainless steel container that has had the internal surfaces specially passivated using a “Summa” process. This process combines an electropolishing step with a chemical deactivation step to produce a surface that is nearly chemically inert. A Summa surface has the appearance of a mirror: bright, shiny, and smooth. The degree of chemical inertness of a whole air sample container is crucial to minimizing reactions with the sample and maximizing recovery of target compounds from the container. Air Toxics Ltd. maintains a large inventory of Summa canisters in 6 and 1 L volumes.

@ AIR TOXICS LTD.

### 2.1.2 Canister Cleaning and Hold Time

Canister sampling differs considerably from collecting a water sample in a VOA vial or a soil sample in an amber jar in that the container (valued at over \$450) is cleaned and reused. A canister will hold a high vacuum (i.e., greater than 25 in. Hg) for more than 30 days. Air Toxics Ltd., however, requires that our canisters be returned within 30 days.

#### ☞ Media hold time for a canister is 30 days

Air Toxics Ltd. provides two types of canister cleaning certification, 10% and 100%, depending upon the requirements of the project. The 10% certification process is appropriate for routine ambient air applications and high concentration applications such as soil vapor and landfill gas monitoring. The 10% certification process begins by cleaning canisters using a combination of dilution, heat, and high vacuum. After completing the cleaning steps, 10% of the canisters are certified each day. Canisters are certified for approximately 60 VOCs using GC/MS by Modified EPA Method TO-15. The 10% certification process requires that target compound concentrations be below 0.2 ppbv. Alternatively, the 100% certification (i.e., individual certification) process is appropriate for ambient and indoor air applications driven by risk assessment or litigation that require pptv (parts per trillion by volume) sensitivity. Similar to the 10% certification, the 100% certification also begins with the canister cleaning process. The difference with the 100% certification is that canisters are individually certified for a client-specific list of target compounds using GC/MS by TO-15. The 100% certified canisters are shipped with analytical documentation demonstrating that they are free of the target compounds down to the project reporting limits.



#### ☞ Specify whether your project requires 10% or 100% canister cleaning certification

Although 14 days is the most commonly cited hold time for a canister sample, the hold time is compound specific. For example, non-polar compounds such as chloroform, benzene, and vinyl chloride are stable in a canister for at least 30 days. In fact, EPA Method TO-15 states: “Fortunately, under conditions of normal usage for sampling ambient air, most VOCs can be recovered from canisters near their original concentrations for after storage times of up to thirty days”. However, recovery of polar compounds such as methanol and acetone begin to drop significantly after 14 days. Analysis of these samples should be performed within 14 days.

#### ☞ Sample hold time to analysis for a canister is 14-30 days for VOCs

@ AIR TOXICS LTD.

## 2.2 Associated Canister Hardware

Associated hardware used with the canister includes the valve, brass cap, particulate filter, and vacuum gauge.

### 2.2.1 Valve

An industry standard, 1/4 in. stainless steel bellows valve (manufactured by Nupro) is mounted at the top of the canister. The valve allows vacuum to be maintained in the canister prior to sampling and seals off the canister once the sample has been collected. No more than a half turn by hand is required to open the valve. Do not over-tighten the valve after sampling or it may become damaged. A damaged valve can leak and possibly compromise the sample. Some canisters have a metal cage near the top to protect the valve.

### 2.2.2 Brass Cap

Each canister comes with a brass cap (i.e., Swagelok 1/4 in. plug) secured to the inlet of the valve assembly. The cap serves two purposes. First, it ensures that there is no loss of vacuum due to a leaky valve or valve that is accidentally opened during handling. Second, it prevents dust and other particulate matter from fouling the valve. The cap is removed prior to sampling and replaced following sample collection.

☞ Always replace the brass cap following canister sampling



### 2.2.3 Particulate Filter

Each canister comes with a particulate filter provided separately in the packing box. The filter prevents particulate matter from fouling the valve (or flow controller) and entering the canister. Particulate filters should be cleaned between uses. Air Toxics Ltd. provides two types of particulate filters: 7 micron and 5 micron. The longer, 7 micron particulate filter is normally used with 6 L canisters and whenever an integrated sample is being collected. This device filters particulate matter greater than 7 microns in diameter and does not significantly restrict the flow rate into the canister. Typical fill times for canisters are shown in the following table. The shorter, 5 micron particulate filter is often used to slow down grab sampling with 1 L canisters and mini-cans. This device is a fritted stainless steel disk that has been pressed into a conventional Swagelok adapter. This device filters particulate matter greater than 5 microns in diameter and has a relatively high pressure drop across the fritted disk. It restricts the flow into the canister and fill times are increased.

☞ Always use the particulate filter for canister sampling

Table 2.2.3 Fill Times for Canisters

CANISTER VOLUME	7 micron filter	5 micron filter
6 L	16 sec	23 min
1 L	3 sec	4 min
400 mL (mini-can)	1-2 sec	1 min 20 sec

### 2.2.4 Vacuum Gauge

A vacuum gauge can be used to measure the initial vacuum of the canister before sampling and the final vacuum upon completion. A gauge can also be used to monitor the fill rate of the canister when collecting an integrated sample. Gauges are generally not used during the brief interval for grab sampling. Gauges are used only to provide a relative measure of “change”. The accuracy of gauges provided by Air Toxics Ltd. is such that gauge-to-gauge comparisons have no merit. Individuals engaged in frequent air sampling or air projects driven by risk assessment or litigation are highly encouraged to purchase and maintain their own gauge. Upon request, Air Toxics Ltd. provides two types of gauges: vacuum gauges reading 0 to 30 in. Hg and vacuum-pressure gauges reading 30 in. Hg to 30 psig (pounds per square inch gage).



☞ Air Toxics Ltd. provides gauges only if requested

## 2.3 Grab Sampling with Canisters

There are two basic modes of canister sampling: grab and integrated. A grab sample is taken over a short interval (i.e., 1-5 minutes) while an integrated sample is taken over an extended period (e.g., 0.5-2 hours for a 1 L canister and 0.5-24 hours for a 6 L canister). In both modes the canister vacuum is used to draw sample into the canister. This is commonly referred to as passive sampling. Active sampling utilizes a pump to fill the canister. The most common hardware configuration used to take a grab sample are illustrated in the following figure. A particulate filter is used to prevent particulate matter from fouling the valve and entering the canister.



### 2.3.1 Considerations for Grab Sampling With Canisters

The following are some considerations for collecting a grab sample in a canister.

- **Avoid Leaks in Sampling Train:** All fittings on the sampling hardware are 1/4 in. Swagelok. A 9/16 in. crescent wrench is used to assemble the hardware. It is not necessary to over tighten the fittings; finger tight plus 1/4 turn with the wrench is adequate. In practice this should be tight enough so that the various pieces of equipment, when assembled, cannot be rotated by hand.
- **Verify Gauge Operation:** If the indicator does not read “zero” upon arrival, the gauge either needs to be equilibrated or the gauge may be damaged and unusable. Equilibrate the gauge by “cracking” the rubber plug on top of the gauge. For more details on the equilibration procedure, see instructions included with the gauge or call Client Services at 800-985-5955.
- **Verify Initial Vacuum of Canister:** Prior to shipment, each canister is checked for mechanical integrity. However, it is still important to check the vacuum of the canister prior to use and record the initial vacuum on the chain-of-custody. The initial vacuum of the canister should be greater than 25 in. Hg. If the canister vacuum is less than 25 in. Hg, do not use it. Call Client Services at 800-985-5955 and arrange for a replacement canister. If sampling at altitude, there are special considerations for gauge readings and sampling (see Section 4.2). The procedure to verify the initial vacuum of a canister is simple, but unforgiving.

1. Confirm that valve is closed (knob should already be tightened clockwise)
2. Remove the brass cap
3. Attach gauge
4. Attach brass cap to side of gauge tee fitting
5. Open and close valve quickly (a few seconds)
6. Read vacuum on the gauge
7. Record gauge reading on “Initial Vacuum” column of chain-of-custody
8. Verify that canister valve is closed and remove gauge
9. Replace the brass cap

- **Leave Residual Vacuum:** A grab sample can be collected either by allowing the canister to reach ambient conditions or by leaving some residual vacuum (e.g., 5 in. Hg) in the canister. In either case, the final vacuum should be noted on the “Final Vacuum” column on the chain-of-custody. This will enable the laboratory to compare the final vacuum with the receipt vacuum (i.e., the vacuum measured upon arrival at the laboratory). If the two readings differ significantly, Client Services will contact you for instructions on how to proceed.

### 2.3.2 Step-by-Step Procedures for Canister Grab Sampling

These procedures are for a typical ambient air sampling application and actual field conditions and procedures may vary.

#### Before you get to the field:

1. Verify contents of the shipped package (e.g., chain-of-custody, canister, particulate filter, and gauge – if requested)
2. Verify that gauge is working properly (see Section 2.3.1)
3. Verify and record initial vacuum of canister (see Section 2.3.1)

#### When ready to sample:

4. Remove brass cap
5. Attach particulate filter to canister
6. Open valve 1/2 turn (6 L canister normally takes about 16 sec to fill)
7. Close valve by hand tightening knob clockwise
8. Verify and record final vacuum of canister (repeat steps used to verify initial vacuum)
9. Replace brass cap
10. Fill out canister sample tag
11. Return canister in box provided
  - Unreturned canister charge of \$450 each
12. Return sample media in packaging provided. Unreturned equipment charges:
  - \$45 per particulate filter
  - \$45 per gauge
13. Fill out chain-of-custody and relinquish samples properly
14. Place chain-of-custody in box and retain pink copy
15. Tape box shut and affix custody seal (if applicable) across flap
16. Ship accordingly to meet method holding times

## 2.4 Integrated Sampling with Canisters and Flow Controllers

An air sample collected over more than a few minutes is referred to as an integrated sample and can provide information on compound concentrations in air averaged or composited over time. An 8- or 10-hour integrated sample can be used to determine indoor air quality in the workplace. Similarly, a 24-hour integrated sample can be an economical and practical approach to determine residential exposure to indoor or outdoor air sources. The most common hardware configurations used to take an integrated sample are illustrated below.

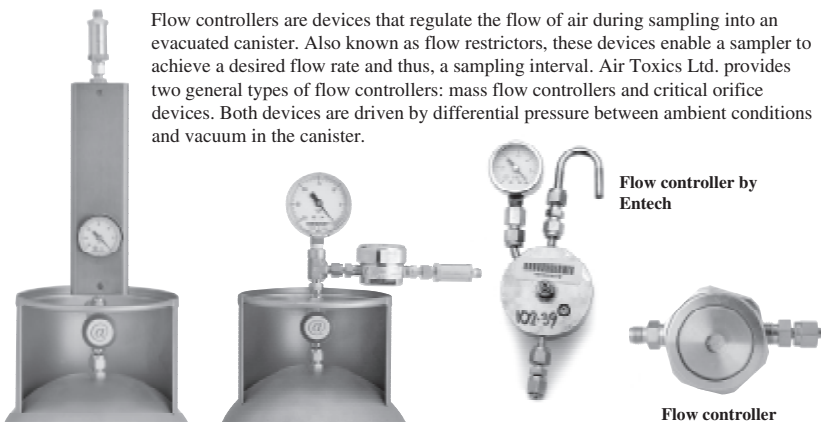

Flow controllers are devices that regulate the flow of air during sampling into an evacuated canister. Also known as flow restrictors, these devices enable a sampler to achieve a desired flow rate and thus, a sampling interval. Air Toxics Ltd. provides two general types of flow controllers: mass flow controllers and critical orifice devices. Both devices are driven by differential pressure between ambient conditions and vacuum in the canister.

Flow controller by Entech

Flow controller by Veriflo

### 2.4.1 Mass Flow Controller

A mass flow controller employs a diaphragm that actively compensates to maintain a constant mass flow rate. As the differential pressure decreases, the flow rate tends to decrease and the diaphragm responds by opening up to allow more air to pass through. Mass flow controllers can be adjustable or fixed and can provide integrated samples with intervals ranging from hours to days. Air Toxics Ltd. provides a fixed mass flow controller that is calibrated at the laboratory for 24-hour sampling. Adjustable mass flow controllers have a knob that can be adjusted in the field to provide integrated samples with intervals ranging from one to 24 hours. The rugged conditions of field sampling are not usually compatible with adjustable mass flow controllers and Air Toxics Ltd. designed a more reliable flow controller based on a critical orifice design.

### 2.4.2 Critical Orifice Device

Air Toxics Ltd. designed a critical orifice flow restrictor to provide integrated samples with intervals from 0.5 to 8 hours. The device restricts air flow by forcing the sample to enter a capillary column of minute radius. This device is passive compared to an actively compensating diaphragm and the flow rate decreases as the driving force (differential pressure) decreases. For sampling intervals from 0.5 to

8 hours, however, the flow rate is relatively constant. The main advantages of the Air Toxics Ltd. flow restrictors are improved ruggedness and cleanliness. With no moving or adjustable parts, the Air Toxics Ltd. design is unlikely to lose its flow setting. In addition, a vacuum gauge is built in to the device to monitor sampling progress. To ensure there are no contamination issues from previous use, the capillary column is replaced before shipping to the field.



### 2.4.3 Sampling Interval and Flow Controller Setting

When you request canisters and flow controllers from Air Toxics Ltd., you will be asked for the sampling interval, and the flow controllers will be pre-set prior to shipment according to the table below. The flow controller is set to collect 5 L of sample over the sample interval. Final canister vacuum is targeted at 5 in. Hg. The flow rate is set at standard atmospheric conditions (approximately sea level). If the air sample is a process (pressurized or under vacuum) or is collected at elevation, the canisters will fill faster or slower depending on the sampling conditions. If you specify the pressure of the source at project set-up, we can set the flow controller accordingly. See Section 4 for a discussion of collecting a sample at elevation. The 24-hr flow controllers should not be used for process or source samples.

Table 2.4.3 Flow Rates for Selected Sampling Intervals (mL/min)

Sampling Interval (hrs)	0.5	1	2	4	8	12	24
6 L Canister	167	83.3	41.7	20.8	11.5	7.6	3.5
1 L Canister	26.6	13.3	6.7	-	-	-	-

Note: Target fill volumes for 6 L and 1 L canisters are 5,000 mL and 800 mL, respectively.

$$\text{Flow Rate (mL/min)} = \frac{\text{Target Fill Volume (mL)}}{\text{Sampling Interval (min)}}$$

### 2.4.4 Final Canister Vacuum and Flow Controller Performance

Ideally the final vacuum of a 6 L canister should be 5 in. Hg or greater. As long as the differential pressure is greater than 4 in. Hg ambient pressure, then the flow through the device will remain approximately constant as the canister fills. If there is insufficient differential pressure, the flow through the controller will decrease as the canister pressure approaches ambient. Because of the normal fluctuations in the flow rate (due to changes in ambient temperature, pressure, and diaphragm instabilities) during sampling, the final vacuum will range between 2 and 10 in. Hg.



- **If the residual canister vacuum is greater than 5 in. Hg** (i.e., more vacuum), the flow rate was low and less than 5 L of sample was collected. When the canister is pressurized to 5 psig prior to analysis, sample dilution will be greater than normal. This will result in elevated reporting limits.
- **If the residual canister vacuum is less than 5 in. Hg** (i.e., less vacuum), the initial flow rate was high. Once the vacuum decreases below 5 in. Hg, the flow rate begins to drop significantly. This scenario indicates that the sample is skewed in favor of the first portion of the sampling interval.
- **If the final vacuum is near ambient** (i.e., less than 1 in. Hg), there is inadequate differential pressure to drive the flow controller. The sampler cannot be certain the desired sampling interval was achieved before the canister arrived at ambient conditions. The sample could have been acquired over a 1-hour interval (which would be the case if the connection between the canister and flow controller leaked or if the flow controller malfunctioned) or a 24-hour interval. Although the actual sampling interval is uncertain, the canister still contains sample from the site.

**Table 2.4.4 Relationship Between Final Canister Vacuum, Volume Sampled, and Dilution Factor (6 L Canister)**

Final Vacuum (in. Hg)	0	2.5	5	7.5	10	12.5	15	17.5	20
Volume Sampled (L)	6	5.5	5	4.5	4	3.5	3	2.5	2
Dilution Factor*	1.34	1.46	1.61	1.79	2.01	2.30	2.68	3.22	4.02

\* Canister pressurized to 5 psig for analysis

$$\text{Final Reporting Limit} = \frac{\text{Method Reporting Limit} \times \text{Dilution Factor (Canister Pressurization)} \times \text{Dilution Factor (Sample Concentration)}}{\text{Dilution Factor (Canister Pressurization)}} = \frac{14.7 \text{ psig} + \text{Press. for Analysis (psig)}}{14.7 \text{ psig} \left[ 1 - \frac{\text{Rec. Vac. (in. Hg)}}{29.9 \text{ in. Hg}} \right]}$$

**2.4.5 Considerations for Integrated Sampling with Canisters**

Collecting an integrated air sample is more involved than collecting a grab sample. Sampling considerations include verifying that the media is ready, monitoring the integrated sampling progress, and avoiding contamination.

- **Avoid Leaks in the Sampling Train:** See Section 2.3.1 for instructions on how to securely assemble sampling hardware. A leak in any one of these connections means that some air will be pulled in through the leak and not through the flow controller. A final pressure near ambient is one indication that there may have been a leak.

- **Verify Initial Vacuum of Canister:** See Section 2.3.1 for instructions on verifying initial canister vacuum. If you are using an Air Toxics Ltd. critical orifice flow controller, note that you can use the built-in gauge. It is important to note both the canister and flow controller serial numbers on the chain-of-custody.
- **Monitor Integrated Sampling Progress:** It is a good idea to monitor the progress of the integrated sampling during the sampling interval. The volume of air sampled is a linear function of canister vacuum. For example, halfway (4 hours) into an 8-hour sampling interval, the canister should be half filled (2.5 L) and the gauge should read approximately 17 in. Hg. More vacuum than 17 in. Hg indicates that the canister is filling too slowly; less than 17 in. Hg and the canister is filling too quickly. If the canister is filling too slowly, a valid sample can still be collected (see Section 2.4.4). If the canister is filling too quickly because of a leak or incorrect flow controller setting, corrective action can be taken. Ensuring all connections are tight may eliminate a leak. It is possible to take an intermittent sample. The time interval need not be continuous. Eight 1-hour increments, taken by opening and closing the canister valve, will yield a valid sample.

**Table 2.4.5 Gauge Readings for an 8-Hour Sampling Interval**

Sampling Interval (hrs)	0	4	8
Canister Vacuum (in. Hg)	29.9	17.4	5
Volume Sampled (L)	0	2.5	5

- **Avoid Contamination:** Flow controllers should be cleaned between uses. This is normally accomplished by returning them to the laboratory. For large air sampling projects, Air Toxics Ltd. has designed a field conditioning program for 24-hour flow controllers involving a purge manifold. This arrangement provides the sampler with scheduling flexibility, inventory control, and convenience in the field. Air Toxics Ltd. will provide the 24-hour flow controllers, a purge manifold, Teflon tubing, rubber ferrules, vacuum pump, and flow meter. The sampler will need to provide the certified nitrogen cylinder and the certified high pressure regulator. Call Client Services at 800-985-5955 if you are interested in the field conditioning program.
- **Keep Sampling Train Out of Direct Sunlight:** The sampling train should be kept out of direct sunlight during sampling. There will be some flow rate drift if the temperature of the controllers is allowed to vary significantly.

**2.4.6 Step-by-Step Procedures for Integrated Sampling**

These procedures are for a typical ambient air sampling application and actual field conditions and procedures may vary.

**Before you get to the field:**

1. Verify contents of the shipped package (e.g., chain-of-custody, canister, particulate filter, and flow controller)
2. Verify initial vacuum of canister (see Section 2.3.1)

**When ready to sample:**

3. Remove brass cap
4. Attach flow controller to canister
5. Attach particulate filter to flow controller
6. Open valve 1/2 turn
7. Monitor integrated sampling progress periodically (see Section 2.4.5)

**At end of sampling interval:**

8. Verify and record final vacuum of canister (for 24-hr flow controller repeat steps used to verify initial vacuum and for critical orifice device simply read built-in gauge)
9. Close valve by hand tightening knob clockwise
10. Replace brass cap
11. Fill out canister sample tag
12. Return canisters in boxes provided
  - Unreturned canister charge of \$450 each
13. Return sample media in packaging provided. Unreturned equipment charges:
  - \$45 per particulate filter
  - \$50-500 per flow controller
14. Fill out chain-of-custody and relinquish samples properly
15. Place chain-of-custody in box and retain pink copy
16. Tape box shut and affix custody seal (if applicable) across flap
17. Ship accordingly to meet method holding times

## Section 3. Tedlar Bag Sampling

This section provides a description of Tedlar bags, practical considerations for sampling, and step-by-step instructions for collecting a grab sample. Photographs illustrate the correct way to assemble the various sampling components.



### 3.1 Introduction to Tedlar Bags

A Tedlar bag is a container used to collect a whole air sample for landfill gas, soil gas, and stationary source applications. The Tedlar bag is best suited for projects involving analysis of compounds in the ppmv range. However, Tedlar bags can be used for other applications such as ambient air monitoring for atmospheric/ fixed gases. They can be used to collect sulfur compounds, but only if the fittings are non-metallic (e.g., polypropylene, Teflon, or Nylon).

A Tedlar bag is made of two plies of Tedlar film sealed together at the edges and features a valve that allows the interior to be filled. Sample collection requires a pressurized sampling port, a low flow rate pump, or a lung sampler. The bag expands as sample enters. When the target volume of sample is collected, the valve is closed and the Tedlar bag is returned to the laboratory. Air Toxics Ltd. maintains a limited inventory of Tedlar bags in 1 L, 3 L, and 5 L volumes.

#### 3.1.1 Tedlar Film

Tedlar is a trade name for polyvinyl fluoride film developed by DuPont Corporation in the 1960s. This patented fluoropolymer has been used in a wide variety of applications including protective surfacing for signs, exterior wall panels, and aircraft interiors. Tedlar film is tough, yet flexible and retains its impressive mechanical properties over a wide range of temperatures (well below freezing to over 200° F). Tedlar exhibits low permeability to gases, good chemical inertness, good weathering resistance, and low off-gassing.

#### 3.1.2 How “Active” is the Surface of a Tedlar Bag?

The surface of a Tedlar bag is a work in progress. The surface of a new bag is essentially free of VOCs at the single digit ppbv level. Compounds detected from analyzing new Tedlar bags include methylene chloride, toluene, acetone, ethanol, and 2-propanol. Note that 2-propanol has been detected in some new bags up to 45 ppbv. Once the Tedlar bag is used, however, the surface has been exposed to moisture and possibly VOCs. It may irreversibly adsorb many VOCs at the low ppbv level. A series of purges with certified gas will not remove the VOCs from the surface. \$15 for a new bag is a small price to pay for peace of mind.

⚠ **Never reuse a Tedlar bag when sampling for trace level compounds**

### 3.1.3 Hold Time for a Tedlar Bag

The media hold time for a Tedlar bag is indefinite if stored out of sunlight in a cool, dry location. Tedlar bags can be used to collect samples containing common solvents, hydrocarbons, chlorinated solvents, sulfur compounds, and many other classes of compounds. The sample hold time to analysis varies for different classes of compounds:

- **1 Day:** Sulfur compounds (e.g., hydrogen sulfide and methyl mercaptan) and chemically active compounds (e.g., 1,3-butadiene).
- **3 Days:** Chlorinated solvents, aromatic compounds, and atmospheric/fixated gases (oxygen, nitrogen, carbon dioxide).

## 3.2 Tedlar Bag Sampling

Using a Tedlar bag to collect an air sample normally involves “active” sampling, unlike an evacuated canister that can be filled “passively” by simply opening the valve. There are two methods commonly used to fill a Tedlar bag: using a pump or a lung sampler.

- **Sampling with a Pump:** The most common method to fill a Tedlar bag is to use a small pump with low flow rates (50-200 mL/min) and tubing to fill the bag. Air Toxics Ltd. does not provide pumps but they can be rented from equipment providers or purchased from manufacturers such as Neuberger or Gilian.

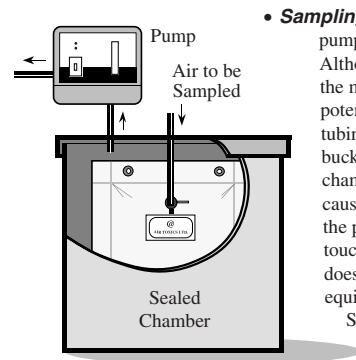
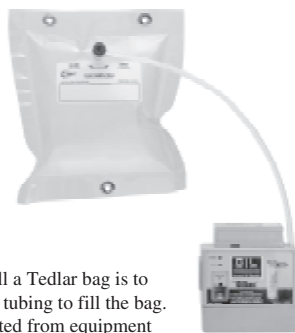

- **Sampling with a Lung Sampler:** Alternatively to using a pump, a “lung sampler” can be used to fill a Tedlar bag. Although a little more complicated than simply using a pump, the main advantage to using a lung sampler is that it avoids potential pump contamination. A Tedlar bag with attached tubing is placed in a small airtight chamber (even a 5-gallon bucket can work) with the tubing protruding from the chamber. The sealed chamber is then evacuated with a pump causing the bag to expand and drawing the sample through the protruding tube into the bag. The sample air never touches the wetted surfaces of the pump. Air Toxics Ltd. does not provide lung samplers, but they can be rented from equipment suppliers or purchased by manufacturers such as SKC Inc.

### 3.2.1 Considerations for Tedlar Bag Sampling

The following are some considerations for collecting a Tedlar bag sample.

- **Fill the Tedlar bag no more than 2/3 full:** Allow for possible expansion due to an increase in temperature or decrease in atmospheric pressure (e.g., the cargo hold of a plane).
- **Keep the Tedlar bag out of sunlight:** Tedlar film is transparent to ultraviolet light (although opaque versions are available) and the sample should be kept out of sunlight to avoid any photochemical reactions.
- **Protect the Tedlar bag:** Store and ship the Tedlar bag samples in a protective box at room temperature. An ice chest can be used, but **DO NOT CHILL**.
- **Fill out the Tedlar bag label:** It is much easier to write the sample information on the label before the Tedlar bag is inflated.
- **Provide a second Tedlar bag:** Consider filling two bags per location in the rare occasion that a defective bag deflates before analysis.
- **Avoid Contamination:** Care should be taken to avoid contamination introduced by the pump or tubing. Begin sampling at locations with the lowest compound concentrations (e.g., sample the SVE effluent before the influent). Decontaminate the pump between uses by purging with certified air for an extended period; better yet, use a lung sampler. Use shortest length possible of Teflon tubing or other inert tubing. Do not reuse tubing. If long lengths of tubing are used, consider purging the tubing with several volumes worth before sampling. If you are concerned about sampling for trace compounds, you shouldn't be using a Tedlar bag (see Section 1.2).
- **Don't Sample Dangerous Compounds in a Tedlar Bag** Do not ship any explosive substances, radiological or biological agents, corrosives, or extremely hazardous materials to Air Toxics Ltd. Tedlar bag rupture during transit to the laboratory is possible and the sampler assumes full liability.

### 3.2.2 Step-by-Step Procedures for Tedlar Bag Sampling (Pump)

Note: These procedures are for a typical stationary source (e.g., SVE system) sampling application; actual field conditions and procedures may vary. See additional sampling considerations in Section 4.3 for sampling soil gas or landfill gas.

#### Before you get to the field:

1. Verify contents of the shipped package (e.g., chain-of-custody, Tedlar bag, and tubing/fittings – if requested)
2. Verify pump cleanliness and operation (Air Toxics Ltd. does not provide pumps)

#### When ready to sample:

3. Purge sample port
4. Attach new Teflon tubing from sample port or probe to low flow rate pump
5. Purge tubing
6. Fill out Tedlar bag sample tag
7. Attach additional new Teflon tubing from the pump outlet to the Tedlar bag valve
8. Open Tedlar bag valve
9. Collect sample (FILL NO MORE THAN 2/3 FULL)
10. Close Tedlar bag valve by hand tightening valve clockwise
11. Return Tedlar bag in boxes provided (DO NOT CHILL)
12. Fill out chain-of-custody and relinquish samples properly
13. Place chain-of-custody in box and retain pink copy
14. Tape box shut and affix custody seal (if applicable) across flap
15. Ship priority overnight to meet method holding times. 3 DAY HOLD TIME TO ANALYSIS (most analyses)

## Section 4. Special Sampling Considerations

This section provides considerations for special sampling configurations that a sampler may collect in the field such as a field duplicate or an ambient blank. This section also provides considerations for sampling at altitude, soil/landfill gas sampling, and sample cylinder sampling.

### 4.1 Special Sampling Configurations

Special sampling configurations include a field duplicate, field split, field blank, trip blank, and an equipment rinse. Call Client Services at 800-985-5955 if your project involves any of these special sampling configurations.

#### 4.1.1 Field Duplicate

A field duplicate is a second sample collected in the field simultaneously with the primary sample at one sampling location. The results of the duplicate sample can be compared (e.g., calculate relative percent difference) with the primary sample to provide information on consistency and reproducibility of field sampling procedures. Due to the nature of the gas phase, duplicate samples should be collected from a common inlet. The configuration for collecting a field duplicate includes stainless steel or Teflon tubing connected to a Swagelock “tee”. It is imperative that individually certified (i.e., 100% certification process) canisters be used to collect a field duplicate.

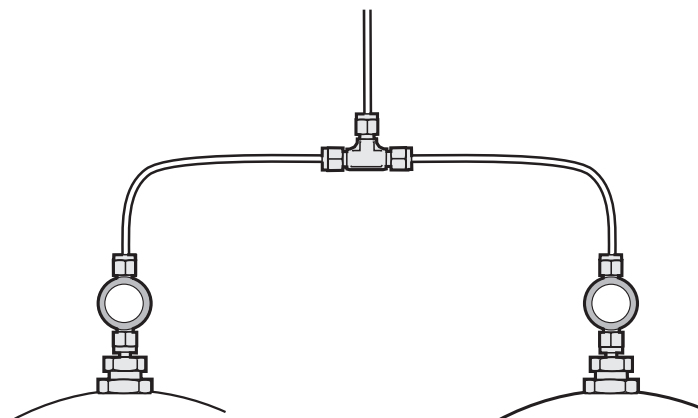

#### 4.1.2 Field Split

A field split is similar to a field duplicate in that two samples are collected in the field simultaneously at one sampling location. The main difference is that the samples are sent to separate analytical laboratories. The results of the split samples can be compared (e.g., calculate relative percent difference) to provide information on consistency and reproducibility of analytical procedures between the laboratories. However, due to the nature of air sampling canisters (different surface conditions, cleaning/certification procedures) and differences in analytical laboratory procedures (common in air analysis) the results are almost always meaningless. Please note that Air Toxics Ltd. does not recommend field splits and does not allow Air Toxics Ltd. canisters or other media to be sent to 3<sup>rd</sup> parties without obtaining prior written consent of Air Toxics Ltd.

#### 4.1.3 Field Blank

A field blank is a sample collected in the field from a certified air source. Analysis of the field blank can provide information on the decontamination procedures used in the field. Clean stainless steel or Teflon tubing and a certified regulator should be used. It is imperative that individually certified canisters (the sample canister and the source canister/cylinder, if applicable) be used to collect a field blank.

#### 4.1.4 Ambient Blank

An ambient blank is an ambient air grab sample collected in the field normally used in conjunction with soil gas or stationary source (e.g., SVE system) sampling. Analysis of the ambient blank can provide information on the ambient levels of site contaminants. It is imperative that an individually certified canister be used to collect an ambient blank.

#### 4.1.5 Trip Blank

When sampling for contaminants in water, the laboratory prepares a trip blank by filling a VOA vial with clean, de-ionized water. The trip blank is sent to the field in a cooler with new sample vials. After sampling, the filled sample vials are placed back in the cooler next to the trip blank and returned to the laboratory. Analysis of the trip blank provides information on decontamination and sample handling procedures in the field as well as the cleanliness of the cooler and packaging.

When sampling for compounds in air, a trip blank provides little, if any, of the information above. A trip blank canister can be individually certified, evacuated, and sent to the field in a box with the sample canisters. Since the valve is closed and the brass cap tightened, it is questionable if the trip blank canister contents are ever “exposed” to sampling conditions. At the laboratory, the trip blank canister will be pressurized prior to analysis with dry, zero air – a matrix that may be entirely different than the sampled air. The recovery of target compounds can vary by matrix (e.g., moisture, carbon dioxide) rendering the trip blank results meaningless. Air Toxics Ltd. does not recommend analyzing a trip blank for air sampling.

#### 4.1.6 Equipment Rinse

When sampling for contaminants in water, an equipment rinse is accomplished in the field by rinsing the decontaminated sampling equipment (e.g., bailer, submersible pump, tubing) with clean, de-ionized

water. A portion of the rinse water is collected in a VOA vial for analysis. The equipment rinse is similar to a field blank in that it provides information on decontamination procedures of sampling equipment.

When sampling for compounds in air, an equipment rinse can be used to determine if a sampling train has been properly decontaminated. Certified air is connected to the sampling train and fills an individually certified canister.

### 4.2 Considerations for Sampling at Altitude

Sampling at altitudes significantly above sea level is similar to sampling a stationary source under vacuum (see Section 4.3) in that target fill volumes may be difficult to achieve. The figure below illustrates the relationship between increasing altitude and decreasing atmospheric pressure. Ambient

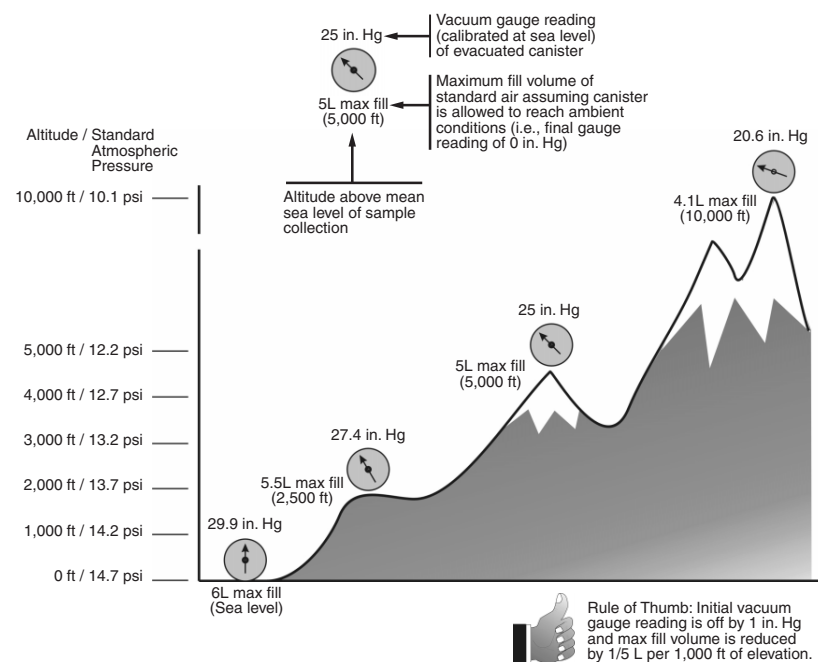

conditions in Denver at 5,000 ft altitude are quite different than ambient conditions at sea level. Canister sampling is driven by the differential pressure between ambient conditions and the vacuum in the canister. There is less atmospheric pressure in Denver and 5 L is the maximum fill volume of standard air assuming the canister is allowed to reach ambient conditions (i.e., final gauge reading of 0 in. Hg). Theoretically, if you sample high enough (e.g., in space), no sample would enter the canister because there is no pressure difference between the evacuated canister and ambient conditions. To fill a canister to 6 L in Denver, you would need to use an air pump.

Sampling at altitude also affects gauge readings. The gauges supplied by Air Toxics Ltd. (see Section 2.2.4) measure canister vacuum relative to atmospheric pressure and are calibrated at approximately sea level. Before sampling at altitude, the gauges should be equilibrated (see Section 2.3.1). But even after equilibrating the gauge, verifying the initial vacuum of a canister at altitude is misleading. In Denver at 5,000 ft, expect the gauge to read 25, not 29.9 in. Hg. You do not have a bad canister (i.e., leaking or not evacuated properly). The canister is ready for sampling and the gauge is working properly.

**☞ Rule of Thumb: For every 1,000 ft of elevation, the gauge will be off by 1 in. Hg and the fill volume will be reduced by 1/5 L**

If you have questions about sampling at altitude, please call Client Services at 800-985-5955.

### 4.3 Considerations for Soil/Landfill Gas Sampling

There are some additional sampling considerations for collecting grab samples (canister or Tedlar bag) from a soil boring, landfill boring, SVE system, or landfill gas (LFG) collection system. The general challenge with these samples arises from the need to employ long lengths of tubing to direct the soil gas, landfill gas, or process air to the canister or Tedlar bag. Tubing introduces the potential for contamination and diluting the sample. A good source of detailed information on soil gas sampling is contained in the ASTM D 5314 Standard Guide for Soil Gas Monitoring in the Vadose Zone.

- **Use inert tubing.** Teflon tubing is recommended. Tubing with an outer diameter of 1/4 in. works best with the fittings on the particulate filter.
- **Do not reuse tubing.** \$2 per foot for new tubing is a small price to pay for peace of mind.
- **Purge tubing adequately.** A long length of tubing has significant volume of “dead air” inside. Without purging, this air will enter the canister and dilute the sample. Consider using a hand-held PID/FID to confirm that you have purged the tubing and are drawing sample air through the tubing.
- **Avoid leaks in the sampling train.** Leaks of ambient air through fittings between pieces of the sampling train (e.g., tubing to particulate filter) will dilute the sample.

- **Don't sample too fast** There is no established flow rate for collecting a soil gas or LFG sample, but sampling slower has advantages. First, any leaks in the sampling train will be less prominent at lower flow rates due to less differential pressure across the leaking connection. Second, sampling slower may allow the conditions in the vadose zone or landfill to equilibrate better and produce a more representative grab sample. Consider using a needle valve or even a 5 micron particulate filter (see Section 2.2.3) to reduce the flow rate into the canister or Tedlar bag.
- **Purge the sample port.** A sample port on a SVE system or LFG collection system can accumulate solids or liquids depending upon the location of the port in the process and the orientation of the port. An influent sample port located upstream of a filter or moisture knock-out can be laden with particulates or saturated with water vapor. Heavy particulate matter can clog the particulate filter and foul the canister valve. It is important to prevent liquids from entering the canister. The presence of water in a canister sample will significantly lower the recovery of both non-polar and polar compounds. A sample port oriented downward may have liquid standing in the valve. Purge the sample port adequately before connecting the sampling train.
- **Consider the effects of sampling a process under vacuum or pressure.** When collecting a grab sample from a stationary source such as an SVE system or LFG collection system, some sample ports may be under vacuum or pressure relative to ambient conditions. When the sample port is under vacuum, such as the header pipe from the extraction well network, it may be difficult to fill the canister with the desired volume of sample. A vacuum pump can be used to collect a canister grab sample from a sample port under considerable vacuum. See the related discussion on sampling at altitude in Section 4.2. When the sample port is under pressure, such as the effluent stack downstream of the blower and treatment system, you may inadvertently pressurize the canister. Only a DOT-approved sample cylinder should be used to transport pressurized air samples (see Section 4.4). Under no circumstances should an Air Toxics Ltd. canister be pressurized more than 5 psig for a 6 L canister and 15 psig for a 1 L canister. Bleed off excess pressure by opening the valve temporarily while monitoring the canister with a pressure gauge.

### 4.4 Considerations for Sample Cylinder Sampling

Sample cylinders, also known as “sample bombs”, are DOT-approved, high pressure, thick-walled, stainless steel cylinders with a valve at each end. They were intended for collecting a pressurized sample for petroleum gas applications. Sample cylinders differ from sample canisters in that they do not have a Summa-passivated interior surface and are not evacuated prior to shipment. Sample cylinders are not suitable for analysis of hydrocarbons at ppbv levels. Sample cylinders can be used for analysis of natural gas by ASTM D-1945 and calculation of Btu by ASTM D-3588. Air Toxics Ltd.



assumes that clients requesting a sample cylinder have a pressurized process and sample port with a built-in gauge and 1/4 in. Swagelock fitting to attach to the sample cylinder. Air Toxics Ltd. has an inventory of 500 mL sample cylinders that are particularly suited for landfill gas collection systems (i.e., LFG to energy applications). This section provides step-by-step procedures for sampling with a sample cylinder.

***Step-by-Step Procedures for Sample Cylinder Sampling***

These procedures are for a typical stationary source sampling application and actual field conditions and procedures may vary. Follow all precautions in the site Health and Safety Plan when dealing with a pressurized sample port and sample cylinder.

1. Verify contents of the shipped package (e.g., chain-of-custody, sample cylinder, particulate filter)
2. Verify that gauge on sample port is working properly
3. Purge sample port
4. Remove brass caps on either end of cylinder
5. Attach particulate filter to upstream valve
6. Attach filter/cylinder assembly directly to the sample port
7. Open both valves 1/2 turn
8. Allow sample air to flow through sample cylinder (approximately 10 L for a 500 mL cylinder)
9. Close downstream valve of sample cylinder by hand tightening knob clockwise
10. Allow sample cylinder to pressurize to process pressure (max 100 psig)
11. Close upstream valve of sample cylinder and sample port
12. Detach filter/cylinder assembly from sample port and remove particulate filter
13. Replace brass caps
14. Fill out sample cylinder sample tag
15. Return sample cylinder in box provided
  - Unreturned sample cylinder charge of \$650 each.
16. Return sample media in packaging provided. Unreturned equipment charges:
  - \$45 per particulate filter
17. Fill out chain-of-custody and relinquish samples properly
18. Place chain-of-custody in box and retain pink copy
19. Tape box shut and affix custody seal (if applicable) across flap
20. Ship accordingly to meet method holding times





# H

## QUANTITATIVE HUMAN HEALTH RISK ASSESSMENT FOR THE SUBSURFACE VAPOR INTRUSION PATHWAY

---

(Courtesy of Menzi-Cura & Associates)

This appendix provides general guidance for conducting human health risk analyses of the subsurface vapor intrusion (SVI) exposure pathway. Such risk analyses can range from simple risk-based screening to site-specific risk assessment, depending on information needs and applicable regulatory requirements. Information provided elsewhere in this manual is not repeated but is instead incorporated by reference. This appendix will help individuals determine whether any SVI effect on indoor air quality poses a significant risk to human health.

Quantitative risk assessment for evaluating subsurface vapor intrusion to indoor air includes the following four steps:

- Hazard Identification
- Exposure Assessment
- Dose-Response Assessment
- Risk Characterization

### H.1 Hazard Identification

The Hazard Identification step consists of evaluating available data and information related to the SVI pathway, assessing whether a human health hazard might exist, and using data of sufficient quality to screen for chemicals of potential concern.

#### ***H.1.1 Check for Imminent Threats to Human Health***

The SVI exposure pathway most often involves relatively low indoor air concentrations that might harm people who are exposed to them over time. These subchronic (i.e. a few weeks to about 7 years) and chronic (i.e. typically years or more) exposure patterns are the subject of this appendix. However, in rare cases, it is possible for chemicals to accumulate to concentrations that might pose an acute health hazard, an explosion hazard, or aesthetic problems. As noted earlier, data and information should be reviewed early to identify such potential imminent threats to human health and appropriate action taken. These threats might be indicated by odors that might, but do not necessarily, indicate a health risk or explosion hazard, or indoor air concentrations that exceed risk-based concentrations for acute toxicity. Additional data collected during an SVI investigation also should be reviewed to identify potential imminent hazards.

### **H.1.2 Develop a Site Conceptual Model**

A conceptual site model (CSM) is developed to describe sources of chemicals, migration pathways, and human receptors. Chapter 2 of this manual, *Development of a Conceptual Model of Site Conditions*, discusses the development of a CSM for the SVI pathway.

### **H.1.3 Evaluate Data Quality**

Data must be of sufficient quality to support a risk assessment. This issue is addressed in detail in Chapter 4. Concentration data should be collected in such a way as to represent the temporal and spatial variability representative of human exposure. For example, data sets biased toward periods of high SVI can be useful for screening, but they are not helpful in defining risks over longer periods of exposure that are typically the subject of SVI investigations.

Data evaluation includes checking for compliance with field and analytical method quality control objectives and whether detection limits are lower than applicable risk-based concentrations (RBCs), which are concentrations that correspond to a specified degree of cancer risk or noncancer hazard. There are some chemicals, such as vinyl chloride, for which it can be difficult to attain some RBCs. This issue might be addressed in a number of ways:

1. Check the assumptions underlying the RBC to see if they are applicable to the exposure scenarios under evaluation. For example, one does not need to attain an RBC based on a residential exposure pattern when the site being evaluated is a workplace.
2. Assuming the RBCs are applicable, look for an analytical laboratory capable of attaining detection limits below the RBCs.
3. If the chemical is never detected after multiple sampling rounds, including periods with the greatest potential for SVI, it is unlikely to contribute significantly to risk, depending upon the degree to which detection limits exceed the RBCs. Screening-level risk calculations possibly could help in demonstrating that the chemical is unlikely to contribute significantly to risk under these circumstances.

### **H.1.4 Identify Chemicals of Concern**

Chemicals of concern (COC) for the indoor air pathway are usually identified by comparing measured or modeled concentrations of groundwater, soil gas, or indoor air to applicable RBCs. Maximum detected concentrations at each exposure point are screened against RBCs. An exposure point represents the area over which one might be exposed. If a chemical is infrequently detected (e.g., less than 5% of the time), it might not screen in as a COC even if its maximum detected concentration exceeds the RBC because its infrequent detection suggests that exposure to the chemical is unlikely to contribute significantly to risk.

## **H.2 Exposure Assessment**

The exposure assessment step involves quantification of potential exposure of humans to volatile chemicals in indoor air under current and future land use conditions. The exposure profiles, or

scenarios, describe potential receptors, activities by which receptors may be exposed to COCs from inhalation of indoor air, and the frequency and duration of exposure.

### H.2.1 Exposure Point Concentrations

Exposure point concentrations (EPCs) are COC concentrations in an environmental medium that represent human exposure over time and space. As noted earlier, concern most often centers on chronic exposures. EPCs are calculated for each exposure scenario, such as office worker or resident. If indoor air data are available, these data are used to estimate the EPC. When indoor air data are unavailable, EPCs can be defined with groundwater or soil gas data, followed by appropriate subsurface vapor modeling to estimate indoor air concentrations that correspond to these EPCs. It is also possible to model EPCs from soil data, but analysis of volatile chemicals in soil is associated with greater uncertainty than analysis of volatile chemicals in groundwater or soil gas.

EPCs can be calculated from the data in a number of ways. For example, Some states recommend use of an arithmetic average of the data. EPA usually requires EPCs to be the 95% upper confidence limit (UCL) on the mean of the data. The mean concentration is of interest when a receptor is equally likely to be anywhere within the exposure point. EPA requires a 95% UCL of this mean to account for sampling error. As sample size increases, the arithmetic mean and 95% UCL should converge. If a screening-level risk estimate is desired, the EPC can be set to an upper percentile of the data or even the maximum concentration.

For groundwater wells sampled multiple times, chemical concentrations may be averaged over time. This temporal averaging results in EPCs that represent concentrations that a receptor is likely to contact over the long term (i.e. incorporating seasonal fluctuations of chemical concentrations in groundwater, soil gas, and indoor air). Similarly, indoor air samples may be averaged across part of an indoor space where an individual spends time. If an individual spends more time in one location than another, a spatially-weighted EPC can be estimated.

### H.2.2 Average Daily Exposure for Inhalation of Vapors

Exposure to chemicals in indoor air is quantified with the average daily exposure (ADE). Two types of ADEs are calculated for inhalation of indoor air: the  $ADE_{\text{year}}$  and the  $ADE_{\text{life}}$ . The  $ADE_{\text{year}}$  is used to evaluate non-carcinogenic effects; it represents the chemical intake during the exposure period for a short-term (subchronic) and long-term (chronic) exposure period. The  $ADE_{\text{life}}$  is used to evaluate carcinogenic effects and exposures are averaged over a lifetime. Most often, a lifespan of 70 years is assumed.

$$ADE \text{ (mg/m}^3\text{)} = \frac{[EPC]_{\text{air}} * EF * ED * EP * CF}{AT}$$

where:      ADE                    = Average Daily Exposure (mg/m<sup>3</sup>)  
                   EPC<sub>air</sub>                    = Exposure Point Concentration for air (mg/m<sup>3</sup>)  
                   EF                         = Exposure Frequency (events/day)

ED	= Exposure Duration (hours/event)
EP	= Exposure Period (days)
CF	= Conversion Factor (1 day/24 hours)
AT	= Averaging Time (days)

Ideally, the exposure assumptions used in the ADE equation are based on realistic current and potential future exposure conditions.

Some regulatory programs and guidance recommend calculation of average daily doses (ADDs) for the inhalation pathway that are identical to the ADE equation except that they incorporate the receptor's inhalation rate and body weight. The ADD is then compared with inhalation toxicity values described in Section 3 below after converting the toxicity values from an exposure to dose basis. However, inhalation toxicity values for specific chemicals might account for more than inhalation rates and body weights specific to receptors and were developed for the purpose of comparison to ADEs rather than ADDs (EPA, 1994). Therefore, this appendix uses ADE instead of ADD to illustrate risk assessment for an SVI investigation.

### **H.3 Dose-Response Assessment**

To quantify cancer risk, one must understand the relationship between the dose received and the incidence of an adverse effect. This relationship is often called the dose-response relationship. For carcinogens, it is expressed as a unit risk (UR) for the inhalation pathway. For noncarcinogens, toxicity benchmarks are derived, called inhalation Reference Concentrations (RfCs).

To determine if a volatile chemical has sufficient toxicity to effect indoor air, the following sources of toxicity data are typically consulted:

- EPA's Integrated Risk Information System (IRIS, <http://www.epa.gov/iris>);
- EPA's Provisional Peer Reviewed Toxicity Values (PPRTVs, <http://hhpprtv.ornl.gov/>)
- The Office of Research and Development / National Center for Environmental Assessment (NCEA, <http://www.epa.gov/ncea>) / Superfund Health Risk Technical Support Center (STSC) develops PPRTVs on a chemical specific basis as requested by EPA's Superfund program.
- California Environmental Protection Agency (CalEPA) toxicity values (<http://www.oehha.ca.gov/risk/ChemicalDB>)
- The Agency for Toxic Substances and Disease Registry (ATSDR) Minimal Risk Levels (MRLs) (<http://www.atsdr.cdc.gov/mrls.html>)
- Health Effects Assessment Summary Tables (HEAST). Annual FY-1997. Office of Research and Development/ Office of Emergency and Remedial Response. U.S. Environmental Protection Agency. OERR 9200.6-303.
- Toxicology Excellence in Risk Assessment International Toxicity Estimates for Risk (ITER) database ([www.tera.org](http://www.tera.org))

### **H.3.1 Carcinogenic Chemicals**

Carcinogenicity via the inhalation route of exposure is defined by URs with units of  $(\mu\text{g}/\text{m}^3)^{-1}$ . Until recently, EPA used a weight of evidence procedure to classify chemicals that give rise to cancer or gene mutations as follows:

- Group A: Human Carcinogen, sufficient human data;
- Group B1: Probable Human Carcinogen, limited human data;
- Group B2: Probable Human Carcinogen, sufficient evidence in animals and limited evidence or no evidence in humans;
- Group C: Possible Human Carcinogen, limited evidence in animals and limited or no evidence in humans;
- Group D: Not Classifiable as to Human Carcinogenicity, insufficient tests for carcinogenesis or mutagenesis are available; and
- Group E: Evidence of Non-Carcinogenicity in Humans.

More recently, EPA's Draft Final Guidelines for Carcinogenic Risk (EPA 2003a) classify human carcinogenic potential as "known/likely", "cannot be determined", and "not likely", to replace the Weight-of-Evidence alphanumeric categories A through E. The proposed Cancer guidelines also acknowledge that the mode of action of a carcinogen may involve both threshold and non-threshold events.

### **H.3.2 Noncarcinogenic Chemicals**

Noncarcinogenic chemical toxicity is described by the RfC, in units of  $\text{mg}/\text{m}^3$ , for inhalation exposures. RfCs are available for chronic and subchronic exposures, and each has an associated degree of confidence (low, medium, or high). An RfC, unlike the UR, is based on the threshold theory, which assumes that there is an experimentally determined threshold dose below which adverse effects are not expected to occur in a large human population, including sensitive subgroups.

### **H.3.3 COCs with No Published Toxicity Values**

Some COCs may be toxic to people but have an inadequate toxicity database to support the derivation of toxicity values. Surrogate toxicity values may be assigned wherever reasonable, based on knowledge of the mechanism(s) of toxicity of the COC or structural similarity. This approach introduces uncertainty into the analysis.

### **H.3.4 Selected Chemicals Commonly Detected at MGP Sites**

Not all chemicals detected at MGP sites are likely to contribute to the SVI pathway due to their relatively low volatility. Also, some chemicals are volatile but have low toxicity and, consequently, are not likely to contribute to significant human health risk from the SVI exposure

pathway. This section summarizes chemicals commonly detected at MGP sites that, under some conditions, might contribute significantly to an SVI pathway.

#### H.3.4.1 Naphthalene

Naphthalene is a volatile chemical that might be important for the SVI pathway. EPA recently issued a draft toxicological review (EPA, 2004) of naphthalene's cancer potency via the inhalation route of exposure. If the draft review is finalized without changes, cancer risk RBCs for naphthalene may be lower than current noncancer hazard RBCs.

#### H.3.4.2 PAHs

Seven PAHs are classified as B2 carcinogens (benzo(a)pyrene (B(a)P), benzo(a)anthracene, benzo(b)fluoranthene, benzo(k)fluoranthene, indeno(1,2,3-cd)pyrene, chrysene, and dibenz(a,h)anthracene). Each of these PAHs generates biologically active metabolites associated with tumor formation. Results are consistent among cancer bioassays involving B(a)P and these PAHs; however, insufficient data are available to derive cancer slope factors (CSFs) for all of these PAHs. Also, while these PAHs are assumed to cause cancer by the same mechanism as B(a)P, most appear to be less potent. EPA developed a relative potency approach to estimate cancer risk associated with these PAHs (EPA, 1993). This approach assumes that these PAHs have dose-response curves similar to that of B(a)P, but that it takes a proportionally larger concentration of these chemicals to induce an equivalent tumor response. To develop relative potency factors, EPA compared PAH relative cancer potencies within and across available cancer bioassays. These relative potency factors (RPFs) are used to assess PAH cancer risk. This RPF approach has been reviewed recently (EPA, 2002a), but no obvious alternative was identified.

The RPF approach is based on toxicological data for the oral route of exposure. Less information is available to evaluate the PAH risk from the inhalation pathway. However, the carcinogenic PAHs are semivolatiles that might not be important for the SVI pathway. EPA (2002b and 2003b) recently evaluated 160 chemicals and determined that 108 of them are sufficiently volatile and toxic to result in potentially unacceptable indoor inhalation risk and have all of the toxicological, physical, and chemical property values needed to assess the SVI pathway (using the J&E model).

EPA concluded that benzo(a)pyrene is not volatile enough to warrant consideration for the SVI pathway, but the same is not true for all carcinogenic PAHs. Specifically, EPA designated two carcinogenic PAHs (benzo(b)fluoranthene and chrysene) and four other PAHs (acenaphthene, fluorene, 2-methylnaphthalene, and pyrene) as sufficiently volatile and toxic to result in a potentially unacceptable indoor inhalation risk.

B(a)P and "PAH mixtures" are currently under toxicological review (see [http://www.epa.gov/iris/frn\\_02\\_09\\_04.htm](http://www.epa.gov/iris/frn_02_09_04.htm)).

### H.3.4.3 Petroleum Fractions

Sites contaminated with petroleum mixtures, such as coal tar, are difficult to evaluate because the composition and distribution of complex petroleum products change following release to the environment. Individual compounds partition differently among environmental media and degrade due to processes such as photolysis and microbial action. For this reason, basing site decisions on whole product (e.g., gasoline, #2 fuel oil, jet fuel) or total petroleum hydrocarbon (TPH) data may be appropriate for fresh spills, but not for older spills that have had time to weather. Moreover, TPH composition depends on the type of petroleum contamination at a site, and TPH measurements can vary according to the analytical method used.

For these reasons, more and more states are adopting fraction-based approaches to petroleum risk assessment (e.g., OR DEQ, 2003; MA DEP, 2002; LA DEQ, 2000). These approaches have been helpful in defining risk to individuals who directly contact media contaminated with petroleum fractions. They typically involve evaluation of individual petroleum hydrocarbons with sufficient toxicological information and petroleum fractions that consist of petroleum hydrocarbons with insufficient toxicological information to evaluate on an individual basis. As a result, these approaches permit risk evaluation of petroleum fractions that would otherwise not be evaluated. The Total Petroleum Hydrocarbon Criteria Working Group defined chemical and physical properties of fractions for use in fate and transport modeling (Gustafson et al., 1997). However, most regulators define fractions over fairly wide carbon number ranges. As a result, vapor intrusion models should be used with caution to predict petroleum fraction concentrations in soil gas or indoor air. MA DEP (2000) defined an analytical method for measuring volatile petroleum fractions in soil gas and indoor air.

## H.4 Risk Characterization

This section describes how to calculate noncancer hazard and cancer risk, which are used to evaluate potential risk to people breathing chemicals in indoor air. There are many volatile chemicals commonly detected in indoor air from building materials, consumer products, and residual contamination in buildings historically used for industrial purposes. These concentrations have been documented (e.g., EPA Building Assessment Survey Evaluation [BASE] study) and must be considered in interpreting and communicating risk estimates.

### H.4.1 Noncancer Hazard

To evaluate potential non-cancer health hazards, the ADE for an individual chemical is divided by the chemical-specific RfC that corresponds to the exposure period of interest, which is often a chronic rather than subchronic or acute exposure period for many SVI studies. The resulting ratio for an individual chemical is referred to as a Hazard Quotient (HQ):

$$\text{Hazard Quotient} = \frac{ADE}{RfC}$$

Where:

ADE = Average Daily Exposure for an individual chemical (mg/m<sup>3</sup>)  
RfC = Chemical-specific Inhalation Reference Concentration (mg/m<sup>3</sup>)

The sum of the HQs for all chemicals in indoor air is referred to as the Hazard Index (HI):

$$\text{Hazard Index} = \sum_i \frac{ADE_i}{RfC_i}$$

This HI is then compared with the applicable noncancer hazard target level, which is usually 1. However, the HI likely overstates the true noncancer hazard if all chemicals do not exert their toxic effects on the same target organ and, possibly, by the same mechanism. Therefore, if an HI is less than 1, one may conclude that the indoor air exposure pathway is not important for noncancer effects. If the HI is more than 1, this exceedance does not necessarily indicate a problem. The analyst should divide the HI before comparing to the target level as described in Section 4.1.1.

#### H.4.1.1 Target Organ Hazard Indices Division

Based on the assumption that noncancer effects occur after an exposure exceeds a threshold target organ concentration, the cumulative noncancer hazard for an individual may be separated according to the target organ upon which toxic effects are exerted, after taking into account the mechanisms of applicable adverse effects. Mixtures risk assessment methods provide tools for evaluating the potential for an exposure to two or more chemicals to result in a response that is greater than or less than that expected from adding the responses of the individual contaminants. Mixtures risk assessment guidance provides a formal framework for evaluating the toxicity of multiple chemicals (EPA, 2000; ATSDR, 2001). Evaluation of the toxicity of mixtures is an active area of research (Teuschler et al., 2002).

The relationship between dose-response and exposure is more complex for mixtures than for a single chemical. The complexity arises because the potential for an interaction and the magnitude of the interaction for two or more chemicals is dependent upon the exposure characteristics and dose-response of all chemicals involved. Therefore, before performing such a division of the total HI, the following factors should be considered:

- When people are exposed to individual chemicals at concentrations greater than those considered health protective (i.e., HI >1), effects may occur in other organs in addition to that of the critical effect;
- Effects of toxicological significance can occur in additional target organs at doses similar to those eliciting the critical effect;
- Relationships between dose level and adverse effects can be complex; and
- There is little information available to judge whether the complex mixtures present at a Site might act additively, synergistically, or antagonistically.



Through evaluation of chemical effects and mode of action information, components of a chemical mixture can be grouped into those that are toxicologically similar, those that are toxicologically independent, and those that interact.

The resulting target organ-specific HIs better reflect the potential for noncancer hazard than the total HI. If the highest target organ-specific HI does not exceed the applicable benchmark, one may conclude that the indoor air exposure pathway is not important for noncancer effects. If the highest target organ-specific HI is more than 1, this exceedance does not necessarily indicate a problem, but substantial effort may be required to demonstrate that there is no problem, including in depth review of the toxicology of the chemical or chemical mixture contributing to the highest target organ-specific HI. ATSDR (2001) and EPA (2000) are beginning to provide guidance for evaluating the toxicology of complex mixtures.

#### H.4.1.2 SVI Contribution to Noncancer Hazard

Ideally, only chemicals associated with the SVI pathway and their breakdown products would be measured in indoor air during an SVI investigation given the prevalence of VOCs in the indoor environment from indoor sources. If this is the case, then the target organ-specific HIs indicate the noncancer hazard from the SVI pathway. In non-SVI chemicals are measured, any contribution they make to target organ-specific HIs should be considered before drawing conclusions about the significance of the SVI pathway. For example, the highest target organ-specific HI might result entirely from non-SVI chemicals. If this is the case, then eliminating the SVI pathway will not mitigate this hazard. Keep in mind that SVI chemicals might “tip the scales” by causing a target organ-specific HI for non-SVI chemicals that is less than 1 to exceed this benchmark.

#### **H.4.2 Cancer Risk**

To estimate carcinogenic risks, the Lifetime Average Daily Exposure ( $ADE_{life}$ ) is multiplied by the UR. The resulting value gives the excess lifetime carcinogenic risk from the exposure of concern (that is, risk above the background carcinogenic risk from all other events associated with daily living). The equation for estimating Excess Lifetime Cancer Risk (ELCR) is:

$$\text{Excess Lifetime Cancer Risk} = ADE_{life} * UR$$

Where:  $ADE_{life}$  = Average Daily Exposure for an individual chemical, averaged over a lifetime ( $mg/m^3$ )  
UR = Chemical-specific Inhalation Unit Risk ( $mg/m^3$ )<sup>-1</sup>

The sum of the ELCRs for all chemicals across in indoor air is referred to as the Cumulative Receptor Cancer Risk. Cumulative Receptor Cancer Risk, or total cancer risk, is compared to a cumulative receptor cancer risk limit.

As discussed in Section 4.1.2, one might want to separate cancer risk estimates attributable to SVI chemicals from cancer risks attributable to non-SVI chemicals to understand the importance of the SVI pathway.

## H.5 Remedial Goals

Results of a risk assessment can be used to communicate any potential risks to building occupants and other interested parties. Also, the results indicate which COCs might warrant some form of remediation. Before acting on these results, one must assess the degree to which risk estimates are attributable to the SVI pathway versus other sources. If the SVI pathway is the reason for significant risk findings and remediation is determined to be the appropriate solution, one can use the exposure assumptions and toxicity information developed for the risk assessment to calculate chemical-specific risk-based concentrations (RBCs) that can be used to help establish remediation goals.

### H.5.1 General Approach for Estimating Risk-Based Concentrations (RBCs)

RBCs are usually developed for both cancer and noncancer endpoints. The noncancer hazard and cancer risk target levels incorporated into RBC calculations tend to vary by regulatory authority; however, a cancer risk target of 1E-06 and a noncancer hazard target of 1 are commonly used. A lower noncancer hazard target level may be used to account for simultaneous exposure to multiple chemicals that exert toxic effects on the same target tissue.

Cumulative target cancer risk and noncancer hazard levels will typically be those of the applicable regulatory authority. No fate and transport modeling is needed to establish remediation goals for indoor air. However, if risk-based remediation goals need to be calculated for groundwater or soil gas, sufficient site-specific data should be collected to model these concentrations. RBCs should ideally be calculated using attenuation factors based on such site-specific information. Additional guidance on this topic is provided in Chapter 5.

### H.5.2 Calculating Indoor Air RBCs

The following equations can be used to quantify indoor air RBCs:

*Non-cancer RBC:*

$$[\text{COC}]_{\text{indoor air}} = \text{Target HI} \times \text{RfC} \times 1000 \mu\text{g}/\text{mg}$$

Where:

$[\text{COC}]_{\text{indoor air}}$  = Non-cancer risk-based concentration in indoor air for the chemical of potential concern ( $\mu\text{g}/\text{m}^3$ )

Target HI = Target hazard index for non-cancer risk representing an allowable inhalation exposure to the COPC (dimensionless)

RfC = Inhalation reference concentration or available toxicity value for the COPC ( $\text{mg}/\text{m}^3$ )

*Cancer RBC:*

$$[\text{COPC}]_{\text{indoor air}} = \text{Target ELCR} / \text{UR}$$

Where:

$[\text{COPC}]_{\text{indoor air}}$  = Cancer risk-based concentration in indoor air for the chemical of potential concern ( $\mu\text{g}/\text{m}^3$ )

Target ELCR = Target Excess Lifetime Cancer Risk (dimensionless)

UR = The inhalation unit risk or available toxicity value for the COPC ( $\mu\text{g}/\text{m}^3$ )<sup>-1</sup>

Using these equations to calculate RBCs assumes a receptor is continually exposed to the indoor air. Site-specific information may be used to develop RBCs specific to receptor exposure patterns at a site, such as a receptor working in a building for 8 hours a day. For example, an adult worker might occupy an office 8 hours per day, 5 days per week, for 25 years. In this case the noncancer RBC would be calculated as follows:

$$[\text{COC}]_{\text{indoor air}} = \frac{\text{Target HI} \times \text{RfC} \times 1000 \mu\text{g}/\text{mg} \times \text{AT}}{\text{EF} \times \text{EP} \times \text{ED} \times \text{CF}}$$

Where:

$[\text{COC}]_{\text{indoor air}}$  = Non-cancer risk-based concentration in indoor air for the chemical of potential concern ( $\mu\text{g}/\text{m}^3$ )

Target HI = Target hazard index for non-cancer risk representing an allowable inhalation exposure to the COPC (dimensionless)

RfC = Inhalation reference concentration or available toxicity value for the COPC ( $\text{mg}/\text{m}^3$ )

EF = Number of exposure events during the exposure period divided by the number of days in the exposure period (e.g., 5 day/wk for 50 wk per year, or 250 events/yr)

ED = Duration of each exposure event (e.g., 8 hr/event)

EP = Duration of the exposure period (e.g., 25 yr)

CF = conversion factor (1 day/24 hour)

The lower of the cancer and non-cancer RBCs is chosen as the indoor air RBC protective of both noncancer hazard and cancer risk at the applied target risk levels.

### **H.5.3 Calculating Soil Gas RBCs**

Soil gas RBCs for the indoor air pathway are calculated by dividing the RBC in indoor air by an appropriate attenuation factor. The attenuation factor models the magnitude of soil gas migrating into indoor air as a result of transport mechanisms, including diffusion and advection through the soil. Attenuation factors are derived using measured soil gas data and indoor air data and can be calculated using vapor intrusion models where a model applicable to site conditions is available.

Soil gas RBCs are calculated as follows:

$$RBC_{\text{soil gas}} = [\text{COPC}]_{\text{indoor air}} / \alpha$$

Where:

$RBC_{\text{soil gas}}$  = Cancer or non-cancer risk-based concentration in soil gas for the chemical of potential concern ( $\mu\text{g}/\text{m}^3$ )

$[\text{COPC}]_{\text{indoor air}}$  = Cancer or non-cancer risk-based concentration in indoor air for the chemical of potential concern ( $\mu\text{g}/\text{m}^3$ )

$\alpha$  = attenuation factor (ratio of indoor air concentration to source concentration (dimensionless))

#### **H.5.4 Calculating Groundwater RBCs**

Groundwater RBCs for the indoor air pathway are similarly calculated by dividing the RBC in indoor air by an appropriate attenuation factor and then converting the soil gas concentration to an equivalent groundwater concentration based on chemical partitioning between the vapor phase and aqueous phase at the water table. Assuming equilibrium partitioning in accordance with Henry's Law, the groundwater RBCs are calculated as:

$$RBC_{\text{groundwater}} = [\text{COPC}]_{\text{indoor air}} / \alpha \times H \times 1000 \text{ liters}/\text{m}^3$$

Where:

$RBC_{\text{groundwater}}$  = Cancer or non-cancer risk-based concentration in groundwater for the chemical of potential concern ( $\mu\text{g}/\text{L}$ )

$[\text{COPC}]_{\text{indoor air}}$  = Cancer or non-cancer risk-based concentration in indoor air for the chemical of potential concern ( $\mu\text{g}/\text{m}^3$ )

$\alpha$  = attenuation factor (ratio of indoor air concentration to source concentration (dimensionless))

$H$  = dimensionless Henry's Law constant at 25C ( $\text{mg}/\text{L}_{\text{vapor}}$  per  $\text{mg}/\text{L}_{\text{water}}$ )

Aqueous solubility of a COPC as well as the maximum possible pure chemical vapor concentration should be considered in the development of soil gas and groundwater RBCs for the indoor air pathway.

## **H.6 References**

- ATSDR (Agency for Toxic Substances and Disease Registry). 2001. Guidance Manual for the Assessment of Joint Toxic Actions of Chemical Mixtures. Atlanta, GA: U.S. Department of Health and Human Services, Public Health Service.
- EPA (United States Environmental Protection Agency). 1993. Provisional Guidance for Quantitative Risk Assessment of Polycyclic Aromatic Hydrocarbons. Environmental Criteria and Assessment Office. July 1993. EPA/600/R-93/089.
- EPA (U.S. Environmental Protection Agency). 1994. Methods for Derivation of Inhalation Reference Concentrations and Applications of Inhalation Dosimetry. Environmental Criteria and Assessment Office, Office of Health and Environmental Assessment, Office of Research and Development. EPA/600/8-90/066F.
- EPA (U.S. Environmental Protection Agency). 2000. Supplementary Guidance for Conducting Health Risk Assessment of Chemical Mixtures. Risk Assessment Forum. EPA/630/R-00/002.
- EPA (United States Environmental Protection Agency). 2002. Peer Consultation Workshop on Approaches to Polycyclic Aromatic Hydrocarbon (PAH) Health Assessment. Office of Research and Development, National Center for Environmental Assessment. EPA/635/R-02/005.
- EPA (United States Environmental Protection Agency). 2002b. Draft Guidance for Evaluating the Vapor Intrusion to Indoor Air Pathway from Groundwater and Soils. November 29, 2002.
- EPA (U.S. Environmental Protection Agency). 2003a. Draft Final Guidelines for Carcinogen Risk Assessment. Risk Assessment Forum U.S. Environmental Protection Agency Washington, DC. February 27, 2003. EPA/630/P-03/001A NCEA-F-0644A.
- EPA (U.S. Environmental Protection Agency). 2003b. User's Guide for Evaluating Subsurface Vapor Intrusion into Buildings. Office of Emergency and Remedial Response. June 19, 2003.
- EPA (United States Environmental Protection Agency). 2004. External Review Draft Toxicological Review of Naphthalene – In Support of Summary Information on the Integrated Risk Information System (IRIS), NCEA-S-1707, June 2004.
- Gustafson, J.; Tell, JG; Orem, D. 1997. TPH Criteria Working Group Series. Volume 3: Selection of Representative TPH Fractions Based on Fate and Transport Considerations. *ISBN 1-884-940-12-9*.
- LA DEQ (Louisiana Department of Environmental Quality). 2000. Risk Evaluation/Corrective Action Program (RECAP). Corrective Action Group. June 20, 2000.
- MA DEP (Massachusetts Department of Environmental Protection). 2000. Method for the Determination of Air-Phase Petroleum Hydrocarbons (APH). Public Comment Draft 1.0. Office of Research and Standards, Bureau of Waste Site Cleanup. February 2000

MA DEP (Massachusetts Department of Environmental Protection). 2002. Characterizing Risks Posed by Petroleum Contaminated Sites: Implementation of the MADEP VPH/EPH Approach. Final Policy. Office of Research and Standards, Bureau of Waste Site Cleanup. October 31, 2002. Policy #WSC-02-411.

OR DEQ (Oregon Department of Environmental Quality). 2003. Risk-Based Decision Making for the Remediation of Petroleum-Contaminated Sites. September 22, 2003.

Teuschler L, Klaunig J, Carney E, Chambers J, Conolly R, Gennings C, Giesy J, Hertzberg R, Klaassen C, Kodell R, Paustenbach D, Yang R. 2002. Support of science-based decisions concerning the evaluation of the toxicology of mixtures: a new beginning. *Regul Toxicol Pharmacol*, 36(1):34-9.



### Export Control Restrictions

Access to and use of EPRI Intellectual Property is granted with the specific understanding and requirement that responsibility for ensuring full compliance with all applicable U.S. and foreign export laws and regulations is being undertaken by you and your company. This includes an obligation to ensure that any individual receiving access hereunder who is not a U.S. citizen or permanent U.S. resident is permitted access under applicable U.S. and foreign export laws and regulations. In the event you are uncertain whether you or your company may lawfully obtain access to this EPRI Intellectual Property, you acknowledge that it is your obligation to consult with your company's legal counsel to determine whether this access is lawful. Although EPRI may make available on a case by case basis an informal assessment of the applicable U.S. export classification for specific EPRI Intellectual Property, you and your company acknowledge that this assessment is solely for informational purposes and not for reliance purposes. You and your company acknowledge that it is still the obligation of you and your company to make your own assessment of the applicable U.S. export classification and ensure compliance accordingly. You and your company understand and acknowledge your obligations to make a prompt report to EPRI and the appropriate authorities regarding any access to or use of EPRI Intellectual Property hereunder that may be in violation of applicable U.S. or foreign export laws or regulations.

### The Electric Power Research Institute (EPRI)

The Electric Power Research Institute (EPRI), with major locations in Palo Alto, CA, and Charlotte, NC, was established in 1973 as an independent, non-profit center for public interest energy and environmental research. EPRI brings together member organizations, the Institute's scientists and engineers, and other leading experts to work collaboratively on solutions to the challenges of electric power. These solutions span nearly every area of power generation, delivery, and use, including health, safety, and environment. EPRI's members represent over 90% of the electricity generated in the United States. International participation represents over 10% of EPRI's total R&D program.

Together...Shaping the Future of Electricity

---

*Program:*

1008492

MGP Site Management

---

© 2005 Electric Power Research Institute (EPRI), Inc. All rights reserved. Electric Power Research Institute and EPRI are registered service marks of the Electric Power Research Institute, Inc.

 Printed on recycled paper in the United States of America